



Factories
Elgin, Illinois

General Office
10 So. Wabash Avenue
Chicago

Branch Offices
15 Maiden Lane, New York
Traders Bank Bldg., Toronto

INTRODUCTION

WE are pleased to present to you our price list of material revised to date. Our plan of cataloguing is, with a few exceptions, the same as we have used for many years.

A description of grades will be found commencing on page 5. Illustrations of our several models will be found on pages 11 to 18 inclusive. Commencing on page 136 will be found serial numbers and grades, with classification and other description, which arrangement is the key to our system of cataloguing. As an example: A third wheel and pinion is wanted for movement No. 11,819,001. Consult numbers commencing on page 136, and it will be found that this movement is Grade 349, Class 65, 18 Size, Full Plate. Now consult index in back part of price list, which indicates that third wheels and pinions are listed on page 126. Under the proper heading Class 65 will be found, and preceding it the catalogue number. The full description given is: No. 1091, Class 7 to 9, 65, 66, 120, 121, price per piece 50 cents, per dozen, \$6.00; 18 size, Full Plate, 5th, 7th, and 11th Models, Quick Train, Flat, Gilded, with 75 teeth in wheel and 10 in pinion. In ordering, specify catalogue number and class, which in this instance are No. 1091, Class 65. Comparing the wheel and pinion to be replaced with illustration No. 1091, it will be found to be the same shape.

In some instances improvements have been made in old grades. An example of this kind would be the changing of escapement in Grade 149 from a single to a double roller. The staff suitable for this movement, as originally made, is No. 857. The staff suitable for use with double roller is No. 2516. As both staffs are used in several grades coming under the head of Class 1, it will be necessary in ordering to determine which kind is wanted by a comparison with illustration.

That there may be no doubt as to what "Class" means as applied to grades of movements, we will say that all grades of a particular size and model that require material of same quality are classed together. In 18 size there are nine grades of movements which are Class 1. When different classes of movements require the same kind of material, the classes are grouped.

In a number of instances we have found it impractical to classify material as in our general plan. Examples of this kind are Clicks, Ratchet Wheels, and Main Wheels used in watches having these pieces exposed. As several styles of finish have been used in grades coming under the same class, we now list these parts in several general divisions. In each of these divisions are noted the chief features of the finishes embraced by them, which serves, in a general way, as a guide for ordering.

In some instances more than one number is applied to the same illustration. The reason for this is that a difference exists which cannot be shown by an illustration. These differences are made clear in the text following illustration numbers.

We particularly call attention to Notes and Tables in different parts of the Catalogue, which will be found very helpful in making correct selections of material.

On page 18 will be found Classes of Material and Grades of Movements to which they are applied.

Respectfully yours,

ELGIN NATIONAL WATCH CO.

MAY, 1915.

GRADES OF MOVEMENTS
WITH
CLASSIFICATION AND DESCRIPTION
AS ORIGINALLY MADE

Grade.	Class.	Size.	Styl.	Model.	Sett.	Train.	Jewels.		
Advance.....	5	18	F. Pl.	Htg.	Gilded	1st to 4th	Key or Lever	Slow	11
Age.....	5	"	"	"	"	"	"	"	7
Avery.....	15	17	"	"	"	1st	Key	"	7
Chief.....	5	18	"	"	"	1st to 4th	Key or Lever	"	7
Culver.....	2	"	"	"	"	"	"	Quick	15
Dexter St.....	48	10	3/4 Pl.	"	"	1st	Key	"	7
Father Time.....	1	18	F. Pl.	"	Nickel	2d to 4th	Lever	"	20-21
Father Time.....	1	"	"	"	"	"	"	"	17
Father Time.....	7	"	"	O. F.	"	5th	Pend.	"	20-21
Father Time.....	7	"	"	"	"	"	"	"	17
Father Time.....	7	"	"	"	"	7th	Lever	"	17-21
Father Time.....	90	"	3/4 Pl.	"	"	8th	"	"	21
Father Time.....	99	"	"	Htg.	"	9th	"	"	21
Father Time.....	134	"	"	O. F.	"	8th	"	"	21
Father Time.....	98	16	"	"	"	15th	"	"	21
Father Time.....	126	"	"	Htg.	"	14th	"	"	21
Father Time.....	126	"	"	"	"	17th	"	"	21
Fargo.....	5	18	F. Pl.	"	Gilded	1st	Key	Slow	7
Farwell.....	5	"	"	"	"	"	"	"	11
Ferry.....	4	"	"	"	"	"	"	"	15
Frances Rubie.....	46	10	3/4 Pl.	"	"	"	"	Quick	15
Frances Rubie.....	78	0	"	"	Nickel	2d	Pend.	"	19
Frances Rubie.....	80	"	"	O. F.	"	3d	"	"	19
Gail Borden.....	48	10	"	Htg.	Gilded	1st	Key	"	11
Lady Elgin.....	47	"	"	"	"	"	"	"	15
Lady Elgin.....	133	5/0	"	"	Nickel	"	Pend.	"	15
Lady Elgin.....	96	10/0	"	O. F.	"	"	"	"	17
Lady Elgin.....	97	"	"	"	"	"	"	"	15
Lady Raymond.....	133	5/0	"	Htg.	"	"	"	"	15
Lady Raymond.....	136	"	"	O. F.	"	2d	"	"	15
Lafin.....	4	18	F. Pl.	"	Gilded	1st to 4th	Key or Lever	Slow	7
Leader.....	15	17	"	"	"	1st to 2d	"	"	7
Lord Elgin.....	36	16	3/4 Pl.	Htg. Br.	Nickel	6th	Pend.	Quick	21
Lord Elgin.....	41	"	"	O. F. Br.	"	7th	"	"	21
Lord Elgin.....	41	"	"	O. F.	"	"	"	"	23
Lord Elgin.....	67	12	"	Htg.	"	2d	"	"	23
Lord Elgin.....	71	"	"	O. F.	"	3d	"	"	23
Lord Elgin.....	135	"	"	"	"	4th	"	"	17
Lord Elgin.....	135	"	"	"	"	"	"	"	21
Ogden.....	5	18	F. Pl.	Htg.	Gilded	1st to 4th	Key or Lever	Slow	11
Overland.....	3	"	"	"	Nickel	2d to 4th	Lever	Quick	17
Overland.....	4	"	"	"	"	"	"	"	17
Overland.....	8	"	"	O. F.	"	5th	Pend.	"	17
Overland.....	9	"	"	"	"	"	"	"	17
Overland.....	66	"	"	"	"	7th	Lever	"	17
Overland.....	123	"	"	Htg.	"	2d to 4th	"	"	17
Overland.....	124	"	"	O. F.	"	7th	"	"	17
Raymond.....	1	"	"	Htg.	Gilded or Nickel	1st to 4th	Key or Lever	"	15-17
Raymond.....	7	"	"	O. F.	"	"	"	"	15-17
Raymond.....	65	"	"	"	Nickel	5th	Pend.	"	17
Raymond.....	91	"	"	"	"	7th	Lever	"	19
Raymond.....	91	"	3/4 Pl.	"	"	8th	"	"	21
Raymond.....	99	"	"	Htg.	"	9th	"	"	21
Raymond.....	134	"	"	O. F.	"	8th	"	"	17
Raymond.....	98	16	"	"	"	15th	"	"	19
Raymond.....	98	"	"	"	"	"	"	"	21
Raymond.....	102	"	"	O. F. Br.	"	9th	"	"	17
Raymond.....	102	"	"	O. F.	"	13th	"	"	17
Raymond.....	102	"	"	"	"	15th	"	"	17
Raymond.....	125	"	"	Htg. Br.	"	8th	"	"	17
Raymond.....	126	"	"	Htg.	"	14th	"	"	19
Raymond.....	126	"	"	"	"	17th	"	"	19
Raymond.....	68	12	"	"	"	2d	Pend.	"	19
Raymond.....	72	"	"	O. F.	"	3d	"	"	19
Ryerson.....	4	18	F. Pl.	Htg.	Gilded	1st	Key	Slow	7
Taylor.....	3	"	"	"	"	2d to 4th	Lever	"	15
Taylor.....	3	"	"	"	Gilded or Nickel	1st to 4th	Key or Lever	Quick	15
Taylor.....	8	"	"	O. F.	Gilded	5th	Pend.	"	15
Veritas.....	89	"	3/4 Pl.	"	Nickel	8th	Lever	"	23
Veritas.....	90	"	"	"	"	"	"	"	21
Veritas.....	99	"	"	Htg.	"	9th	"	"	21
Veritas.....	98	16	"	O. F. Br.	"	"	"	"	21
Veritas.....	98	"	"	O. F.	"	13th	"	"	21
Veritas.....	98	"	"	"	"	"	"	"	23
Veritas.....	98	"	"	"	"	15th	"	"	21
Veritas.....	132	"	"	"	"	"	"	"	23
Wheeler.....	4	18	F. Pl.	Htg.	Gilded	1st to 4th	Key or Lever	Slow	15
Wheeler.....	4	"	"	"	Gilded or Nickel	"	Lever	Quick	13-15
Wheeler.....	4	"	"	"	"	2d to 4th	"	"	15-17
Wheeler.....	9	"	"	O. F.	"	5th	Pend.	"	15-17

ELGIN NATIONAL WATCH CO.

Grades of Movements with Classification and Description as Originally Made

Grade.	Class.	Size.	Style.	Model.	Sett.	Train.	Jewels.		
Wheeler	122	18	F. Pl.	O. F.	Nickel	7th	Lever	Quick	17
Wheeler	123	"	"	Htg.	"	2d to 4th	"	"	17
Wheeler	124	"	"	O. F.	"	7th	"	"	17
Wheeler	130	"	3/4 Pl.	Htg.	"	9th	"	"	17
Wheeler	131	"	"	O. F.	"	8th	"	"	17
Wheeler	33	16	"	Htg. Br.	"	6th	Pend.	"	17
Wheeler	38	"	"	O. F. Br.	"	7th	"	"	17
Wheeler	127	"	"	"	"	9th	Lever	"	17
Wheeler	111	12	"	Htg.	"	2d	Pend.	"	17
Wheeler	112	"	"	O. F.	"	3d	"	"	17
No. 1	25	16	"	Htg.	Gilded	"	Lever	"	7
No. 2	25	"	"	"	"	"	"	"	13-15
No. 3	24	"	"	"	"	"	"	"	15
No. 4	24	"	"	"	Nickel	"	"	"	15
No. 5	5	18	F. Pl.	"	"	2d to 4th	"	Q. or S.	11
No. 6	6	"	"	"	Gilded	"	"	Slow	7
No. 7	6	"	"	"	"	1st	Key	"	7
No. 8	5	"	"	"	"	2d to 4th	Lever	"	7
No. 9	5	"	"	"	"	"	"	"	7
No. 10	5	"	"	"	"	"	"	Q. or S.	11
No. 11	15	17	"	"	"	2d	"	Slow	7
No. 12	5	18	"	"	"	1st	Key	"	7
No. 13	5	"	"	"	"	"	"	"	11
No. 14	15	17	"	"	"	"	"	"	7
No. 15	15	"	"	"	"	"	"	"	11
No. 16	4	18	"	"	"	"	"	"	7
No. 17	4	"	"	"	"	"	"	"	11
No. 18	5	"	"	"	"	"	"	"	11
No. 19	5	"	"	"	"	2d to 4th	Lever	"	11
No. 20	3	"	"	"	"	"	"	"	15
No. 21	48	10	3/4 Pl.	"	"	1st	Key	Quick	7
No. 22	48	"	"	"	"	"	"	"	11
No. 23	47	"	"	"	"	"	"	"	15
No. 24	45	12	"	"	"	"	"	"	7
No. 25	45	"	"	"	"	"	"	"	11
No. 26	44	"	"	"	"	"	"	"	15
No. 27	1	18	F. Pl.	"	Nickel	2d to 4th	Lever	"	15-17
No. 28	48	10	3/4 Pl.	"	Gilded	1st	Key	"	7
No. 29	47	"	"	"	"	"	"	"	11
No. 30	45	12	"	"	"	"	"	"	7
No. 31	45	"	"	"	"	1st	"	"	7
No. 32	44	"	"	"	"	"	"	"	11
No. 33	3	18	F. Pl.	"	Nickel	2d to 4th	Lever	"	15
No. 34	43	14	3/4 Pl.	"	Gilded	1st	Key	"	7
No. 35	43	"	"	"	"	"	"	"	7
No. 36	43	"	"	"	"	"	"	"	11
No. 37	42	"	"	"	"	"	"	"	15
No. 38	3	18	F. Pl.	"	"	"	"	Slow	15
No. 39	43	14	3/4 Pl.	"	"	"	"	Quick	13
No. 40	43	"	"	"	"	"	"	"	7
No. 41	42	"	"	"	"	"	"	"	13
No. 42	42	"	"	"	"	"	"	"	15
No. 43	10	18	F. Pl.	O. F.	Nickel	5th	Pend.	"	11
No. 44	9	"	"	"	"	"	"	"	15
No. 45	51	6	3/4 Pl.	Htg.	"	1st	Lever	"	13
No. 46	42	14	"	"	"	"	Key	"	15
No. 47	19	16	"	Htg. and O.F.	Gilded	"	Lever	"	7
No. 48	18	"	"	"	"	"	"	"	13
No. 49	17	"	"	"	"	"	"	"	15
No. 50	17	"	"	"	Nickel	"	"	"	15
No. 51	15	17	F. Pl.	Htg.	Gilded	1st	Key	Slow	7
No. 52	15	"	"	"	"	"	"	"	11
No. 53	48	10	3/4 Pl.	"	"	"	"	Quick	7
No. 54	48	"	"	"	"	"	"	"	13
No. 55	5	18	F. Pl.	"	"	"	"	Slow	7
No. 56	4	"	"	"	"	"	"	"	11
No. 57	4	"	"	"	"	"	"	"	13
No. 58	3	"	"	"	"	"	"	"	15
No. 59	15	17	"	"	"	"	"	"	7
No. 60	5	18	"	"	"	"	"	"	7
No. 61	2	"	"	"	"	2d to 4th	Lever	Quick	15
No. 62	2	"	"	"	"	1st	Key	"	15
No. 63	4	"	"	"	"	2d to 4th	Lever	Slow	13
No. 64	51	6	3/4 Pl.	"	"	1st	"	Quick	7
No. 65	51	"	"	"	"	"	"	"	13
No. 66	50	"	"	"	"	"	"	"	15
No. 67	50	"	"	"	"	"	"	"	7
No. 68	5	18	F. Pl.	"	Nickel	2d to 4th	"	Slow	7
No. 69	1	"	"	"	Gilded	1st	Key	Quick	15
No. 70	1	"	"	"	"	2d to 4th	Lever	"	15-17
No. 71	49	6	3/4 Pl.	"	Nickel	1st	"	"	17
No. 72	16	16	"	Htg. and O.F.	"	"	"	"	21
No. 73	11	18	F. Pl.	O. F.	Gilded	5th	Pend.	"	7
No. 74	10	"	"	"	"	"	"	"	11
No. 75	9	"	"	"	"	"	"	"	15
No. 76	8	"	"	"	"	"	"	"	15
No. 77	7	"	"	"	"	"	"	"	15-17
No. 78	5	"	"	Htg.	Nickel	1st	Key	Q. or S.	11
No. 79	3	"	"	"	Gilded	"	"	Quick	15

ELGIN NATIONAL WATCH CO.

7

Grades of Movement with Classification and Description as Originally Made.

Grade.	Class.	Size.	Style.		Model.	Sett.	Train.	Jewels.
No. 80.	3	18	F. Pl.	Htg.	Gilded	2d to 4th	Lever	Quick 15
No. 81.	4	"	"	"	"	1st	Key	" 13-15
No. 82.	4	"	"	"	"	2d to 4th	Lever	" 13-15
No. 83.	27	10	3/4 Pl.	S. Sec.	"	4th	"	" 15
No. 84.	27	"	"	"	Nickel	"	"	" 15
No. 85.	22	"	"	Htg. and O.F.	Gilded	2d	"	" 15
No. 86.	22	"	"	"	Nickel	"	"	" 15
No. 87.	5	18	F. Pl.	Htg.	"	1st	Key	" 11
No. 88.	5	"	"	"	"	2d to 4th	Lever	" 11
No. 89.	28	16	3/4 Pl.	S. Sec.	Gilded	4th	"	" 13
No. 90.	23	"	"	Htg. and O.F.	"	2d	"	" 13
No. 91.	21	"	"	"	Nickel	"	"	" 21
No. 92.	26	"	"	Htg.	Gilded	3d	"	" 11
No. 93.	20	"	"	Htg. and O.F.	"	1st	"	" 11
No. 94.	52	6	"	Htg.	"	"	"	" 11
No. 95.	52	"	"	"	"	"	"	" 7
No. 96.	6	18	F. Pl.	"	"	2d to 4th	"	" 7
No. 97.	6	"	"	"	"	1st	Key	" 7
No. 98.	14	"	3/4 Pl.	Htg. and O.F.	"	6th	Pend.	" 7
No. 99.	13	"	"	"	"	"	"	" 11
No. 100.	12	"	"	"	"	"	"	" 15
No. 101.	52	6	"	Htg.	Nickel	1st	Lever	" 11
No. 102.	5	18	F. Pl.	"	"	2d to 4th	"	" 11
No. 103.	4	"	"	"	"	"	"	" 15
No. 104.	31	10	3/4 Pl.	O. F.	Gilded	5th	Pend.	" 7
No. 105.	31	"	"	"	"	"	"	" 11
No. 106.	30	"	"	"	"	"	"	" 13-15
No. 107.	29	"	"	"	"	"	"	" 15
No. 108.	29	"	"	"	Nickel	"	"	" 15
No. 109.	60	0	"	Htg.	Gilded	1st	"	" 7
No. 110.	60	"	"	"	Nickel	"	"	" 11
No. 111.	58	"	"	"	"	"	"	" 15
No. 112.	57	"	"	"	"	"	"	" 17
No. 113.	60	"	"	"	Gilded	"	"	" 11
No. 114.	26	16	"	"	"	3d	"	" 7
No. 115.	0	"	"	"	Nickel	1st	"	" 13
No. 116.	7	13	F. Pl.	O. F.	"	5th	"	" 15-17
No. 117.	6	"	3/4 Pl.	Htg.	Gilded	2d	"	" 7
No. 118.	56	"	"	"	"	"	"	" 11
No. 119.	56	"	"	"	Nickel	"	"	" 11
No. 120.	55	"	"	"	"	"	"	" 13
No. 121.	54	"	"	"	"	"	"	" 15
No. 122.	53	"	"	"	"	"	"	" 17
No. 123.	9	18	F. Pl.	O. F.	Gilded	5th	"	" 15
No. 124.	9	"	"	"	Nickel	"	"	" 15
No. 125.	4	"	"	Htg.	Gilded	2d to 4th	Lever	" 15
No. 126.	4	"	"	"	Nickel	"	"	" 15
No. 127.	26	16	3/4 Pl.	"	"	3d	"	" 11
No. 128.	31	"	"	"	"	5th	Pend.	" 11
No. 129.	60	0	"	O. F.	Gilded	1st	"	" 15
No. 130.	60	"	"	Htg.	Nickel	"	"	" 15
No. 131.	58	"	"	"	"	"	"	" 15
No. 132.	56	6	"	"	Gilded	2d	"	" 15
No. 133.	56	"	"	"	Nickel	"	"	" 15
No. 134.	54	"	"	"	"	"	"	" 15
No. 135.	28	16	"	"	Gilded	3d	Lever	" 15
No. 136.	26	"	"	"	Nickel	"	"	" 15
No. 137.	25	"	"	"	Gilded	"	"	" 13-15
No. 138.	31	"	"	O. F.	"	5th	Pend.	" 15
No. 139.	31	"	"	"	Nickel	"	"	" 15
No. 140.	30	"	"	"	Gilded	"	"	" 13-15
No. 141.	5	18	F. Pl.	Htg.	"	2d to 4th	Lever	" 15
No. 142.	5	"	"	"	Nickel	"	"	" 15
No. 143.	4	"	"	"	Gilded	"	"	" 15-17
No. 144.	4	"	"	"	Nickel	"	"	" 15-17
No. 145.	10	"	"	O. F.	Gilded	5th	Pend.	" 15
No. 146.	9	"	"	"	Nickel	"	"	" 15
No. 147.	9	"	"	"	Gilded	"	"	" 15-17
No. 148.	9	"	"	"	Nickel	"	"	" 15-17
No. 149.	1	"	"	"	"	"	"	" 20-21
No. 150.	7	"	"	Htg.	"	2d to 4th	Lever	" 20-21
No. 151.	35	16	3/4 Pl.	O. F.	"	5th	Pend.	" 7
No. 152.	35	"	"	Htg.	Gilded	6th	"	" 15
No. 153.	34	"	"	"	Nickel	"	"	" 17
No. 154.	33	"	"	"	"	"	"	" 17
No. 155.	32	"	"	"	"	"	"	" 17
No. 156.	36	"	"	"	"	"	"	" 21
No. 157.	40	"	"	Htg. Br.	Gilded	7th	"	" 7
No. 158.	40	"	"	O. F.	Nickel	"	"	" 15
No. 159.	39	"	"	"	"	"	"	" 17
No. 160.	38	"	"	"	"	"	"	" 17
No. 161.	37	"	"	"	"	"	"	" 17
No. 162.	41	"	"	"	"	"	"	" 21
No. 163.	3	18	F. Pl.	Htg.	"	2d to 4th	Lever	" 17
No. 164.	1	"	"	"	"	"	"	" 17
No. 165.	8	"	"	O. F.	"	5th	Pend.	" 17
No. 166.	7	"	"	"	"	"	"	" 17
No. 167.	58	0	3/4 Pl.	Htg.	"	1st	"	" 16
No. 168.	54	6	"	"	"	2d	"	" 16

ELGIN NATIONAL WATCH CO.

Grades of Movements with Classification and Description as Originally Made.

Grade.	Class.	Size.	Style.		Model.	Sett.	Train.	Jewels.	
No. 169.	5	18	F. Pl.	Htg.	Nickel	2d to 4th	Lever	Quick	15
No. 170.	10	"	"	O. F.	"	5th	Pend.	"	15
No. 171.	5	"	"	Htg.	"	2d to 4th	Lever	"	7
No. 172.	11	"	"	O. F.	"	5th	Pend.	"	7
No. 173.	60	0	3/4 Pl.	Htg.	"	1st	"	"	7
No. 174.	57	"	"	"	"	"	"	"	17
No. 175.	56	6	"	"	"	2d	"	"	7
No. 176.	53	"	"	"	"	"	"	"	17
No. 177.	"	"	"	"	"	"	"	"	7
No. 178.	"	18	F. Pl.	"	"	2d to 4th	Lever	"	7
No. 179.	"	"	"	O. F.	"	5th	Pend.	"	7
No. 180.	65	"	"	"	Nickel	7th	Lever	"	17
No. 181.	65	"	"	"	"	"	"	"	21
No. 182.	31	16	3/4 Pl.	"	Gilded	5th	Pend.	"	7
No. 183.	1	18	F. Pl.	Htg.	Nickel	2d to 4th	Lever	"	17
No. 184.	7	"	"	O. F.	"	5th	Pend.	"	17
No. 185.	35	16	3/4 Pl.	Htg.	Gilded	6th	"	"	15
No. 186.	40	"	"	O. F.	"	7th	"	"	15
No. 187.	70	12	"	Htg.	Nickel	2d	"	"	15
No. 188.	69	"	"	"	"	"	"	"	17
No. 189.	68	"	"	"	"	"	"	"	19
No. 190.	67	"	"	"	"	"	"	"	23
No. 191.	74	"	"	O. F.	"	3d	"	"	15
No. 192.	73	"	"	"	"	"	"	"	17
No. 193.	72	"	"	"	"	"	"	"	19
No. 194.	71	"	"	"	"	"	"	"	23
No. 195.	31	16	"	"	Gilded	5th	"	"	15
No. 196.	70	12	"	Htg.	Nickel	2d	"	"	7
No. 197.	74	"	"	O. F.	"	3d	"	"	7
No. 198.	79	0	"	Htg.	"	2d	"	"	7
No. 199.	78	"	"	"	"	"	"	"	15
No. 200.	77	"	"	"	"	"	"	"	17
No. 201.	76	"	"	"	"	"	"	"	19
No. 202.	83	"	"	O. F.	"	3d	"	"	7
No. 203.	82	"	"	"	"	"	"	"	15
No. 204.	81	"	"	"	"	"	"	"	17
No. 205.	80	"	"	"	"	"	"	"	19
No. 206.	75	6	"	Htg.	"	2d	"	"	7
No. 207.	61	18	F. Pl.	"	"	2d to 4th	Lever	"	7
No. 208.	63	"	"	O. F.	"	5th	Pend.	"	7
No. 209.	75	6	3/4 Pl.	Htg.	Gilded	2d	"	"	7
No. 210.	92	16	"	"	Nickel	6th	"	"	7
No. 211.	94	"	"	O. F.	"	7th	"	"	7
No. 212.	92	"	"	Htg.	Gilded	6th	"	"	7
No. 213.	94	"	"	O. F.	"	7th	"	"	7
No. 214.	89	18	"	"	Nickel	8th	Lever	"	23
No. 215.	63	"	F. Pl.	"	Gilded	5th	Pend.	"	7
No. 216.	75	6	3/4 Pl.	Htg.	Nickel	2d	"	"	15
No. 217.	61	18	F. Pl.	"	"	2d to 4th	Lever	"	15
No. 218.	63	"	"	O. F.	"	5th	Pend.	"	15
No. 219.	84	0	3/4 Pl.	Htg.	Gilded	1st	"	"	7
No. 220.	92	16	"	"	Nickel	6th	"	"	15
No. 221.	94	"	"	O. F.	"	7th	"	"	15
No. 222.	84	0	"	Htg.	"	1st	"	"	7
No. 223.	84	"	"	"	"	"	"	"	15
No. 224.	85	"	"	"	"	2d	"	"	11
No. 225.	86	"	"	"	"	3d	"	"	11
No. 226.	5	18	F. Pl.	Htg.	Gilded	2d to 4th	Lever	"	17
No. 227.	10	"	"	O. F.	"	5th	Pend.	"	17
No. 228.	5	"	"	Htg.	Nickel	2d to 4th	Lever	"	17
No. 229.	10	"	"	O. F.	"	5th	Pend.	"	17
No. 230.	56	6	3/4 Pl.	Htg.	Gilded	2d	"	"	16
No. 231.	56	"	"	"	Nickel	"	"	"	16
No. 232.	87	12	"	"	"	"	"	"	7
No. 233.	87	"	"	"	"	"	"	"	15
No. 234.	88	"	"	O. F.	"	3d	"	"	7
No. 235.	88	"	"	"	"	"	"	"	15
No. 236.	68	"	"	Htg.	"	2d	"	"	21
No. 237.	72	"	"	O. F.	"	3d	"	"	21
No. 238.	61	18	F. Pl.	Htg.	Gilded	1st	Key	"	7
No. 239.	90	"	3/4 Pl.	O. F.	Nickel	8th	Lever	"	21
No. 240.	91	"	"	"	"	"	"	"	19
No. 241.	33	16	"	Htg. Br.	"	6th	Pend.	"	17
No. 242.	33	"	"	"	"	"	"	"	17
No. 243.	32	"	"	"	"	"	"	"	17
No. 244.	38	"	"	O. F. Br.	"	7th	"	"	17
No. 245.	38	"	"	"	"	"	"	"	17
No. 246.	37	"	"	"	"	"	"	"	17
No. 247.	93	"	"	Htg. Br.	"	6th	"	"	15
No. 248.	93	"	"	O. F. Br.	"	7th	"	"	15
No. 249.	62	18	F. Pl.	Htg.	Gilded	2d to 4th	Lever	"	17
No. 250.	64	"	"	O. F.	"	5th	Pend.	"	17
No. 251.	61	"	"	Htg.	"	2d to 4th	Lever	"	7
No. 252.	65	"	"	O. F.	Nickel	7th	"	"	7
No. 253.	87	12	3/4 Pl.	Htg.	Gilded	2d	Pend.	"	21
No. 254.	88	"	"	O. F.	"	3d	"	"	7
No. 255.	97	10/0	"	"	Nickel	1st	"	"	15
No. 256.	96	"	"	"	"	"	"	"	17
No. 257.	92	16	"	Htg.	"	6th	"	"	15

ELGIN NATIONAL WATCH CO.

Grades of Movements with Classification and Description as Originally Made.

Grade.	Class.	Size.	Style.	Model.	Sett.	Train.	Jewels.	
No. 258	94	16	3/4 Pl. O. F.	Nickel	7th	Pend.	Quick	15
No. 259	87	12	Htg.	"	2d	"	"	15
No. 260	88	"	O. F.	"	3d	"	"	15
No. 261	61	18	F. Pl. Htg.	"	2d to 4th	Lever	"	15
No. 262	63	"	O. F.	"	5th	Pend.	"	15
No. 263	77	0	3/4 Pl. Htg.	"	2d	"	"	17
No. 264	81	"	O. F.	"	3d	"	"	17
No. 265	66	18	F. Pl. Htg.	"	7th	Lever	"	17
No. 266	65	"	"	"	"	"	"	17-21
No. 267	85	0	3/4 Pl. Htg.	"	2d	Pend.	"	15
No. 268	86	"	O. F.	"	3d	"	"	15
No. 269	85	"	Htg.	"	2d	"	"	7
No. 270	98	16	O. F. Br.	"	9th	Lever	"	21
No. 271	60	0	Htg.	"	1st	Pend.	"	16
No. 272	56	6	"	"	2d	"	"	16
No. 273	65	18	F. Pl. O. F.	"	7th	Lever	"	17
No. 274	99	"	3/4 Pl. Htg.	"	9th	"	"	21
No. 275	100	12	"	"	2d	Pend.	"	17
No. 276	101	"	O. F.	"	3d	"	"	17
No. 277	65	18	F. Pl. Htg.	"	7th	Lever	"	21
No. 278	4	"	"	"	"	"	"	17
No. 279	9	"	Htg.	"	2d to 4th	"	"	17
No. 280	102	16	3/4 Pl. O. F. Br.	"	5th	Pend.	"	17
No. 281	85	0	Htg.	"	9th	Lever	"	17
No. 282	86	"	O. F.	"	2d	Pend.	"	11
No. 283	66	18	F. Pl. Htg.	"	3d	"	"	7
No. 284	75	6	3/4 Pl. Htg.	Gilded	7th	Lever	"	17
No. 285	63	18	F. Pl. O. F.	"	2d	Pend.	"	15
No. 286	115	6	3/4 Pl. Htg.	Nickel	5th	"	"	15
No. 287	105	18	F. Pl. Htg.	"	2d	Lever	"	7
No. 288	106	"	O. F.	"	2d to 4th	Pend.	"	7
No. 289	115	6	3/4 Pl. Htg.	Gilded	5th	"	"	7
No. 290	109	16	"	Nickel	2d	"	"	7
No. 291	110	"	O. F.	"	6th	"	"	7
No. 292	109	"	Htg.	"	7th	"	"	7
No. 293	110	"	O. F.	Gilded	6th	"	"	7
No. 294	106	18	F. Pl. Htg.	"	7th	"	"	7
No. 295	115	6	3/4 Pl. Htg.	Nickel	5th	"	"	7
No. 296	105	18	F. Pl. Htg.	"	2d	"	"	15
No. 297	106	"	O. F.	"	2d to 4th	Lever	"	15
No. 298	116	0	3/4 Pl. Htg.	Gilded	5th	Pend.	"	15
No. 299	109	16	"	Nickel	2d	"	"	7
No. 300	110	"	O. F.	"	6th	"	"	15
No. 301	113	12	Htg.	"	7th	"	"	15
No. 302	113	"	"	"	2d	"	"	7
No. 303	114	"	O. F.	"	3d	"	"	15
No. 304	114	"	"	"	"	"	"	15
No. 305	107	16	Htg. Br.	"	6th	"	"	15
No. 306	108	"	O. F. Br.	"	7th	"	"	15
No. 307	103	18	F. Pl. Htg.	Gilded	2d to 4th	Lever	"	17
No. 308	104	"	O. F.	"	5th	Pend.	"	17
No. 309	105	"	Htg.	"	2d to 4th	Lever	"	7
No. 310	113	12	3/4 Pl. Htg.	"	2d	Pend.	"	7
No. 311	114	"	O. F.	"	3d	"	"	7
No. 312	109	16	Htg.	Nickel	6th	"	"	15
No. 313	110	"	O. F.	"	7th	"	"	15
No. 314	113	12	Htg.	"	2d	"	"	15
No. 315	114	"	O. F.	"	3d	"	"	15
No. 316	105	18	F. Pl. Htg.	"	2d to 4th	Lever	"	15
No. 317	106	"	O. F.	"	5th	Pend.	"	15
No. 318	116	0	3/4 Pl. Htg.	"	2d	"	"	15
No. 319	117	"	O. F.	"	3d	"	"	15
No. 320	116	"	Htg.	"	2d	"	"	7
No. 321	111	12	"	"	"	"	"	17
No. 322	112	"	O. F.	"	3d	"	"	17
No. 323	116	0	Htg.	"	2d	"	"	11
No. 324	117	"	O. F.	"	3d	"	"	7
No. 325	115	6	Htg.	Gilded	2d	"	"	15
No. 326	106	18	F. Pl. O. F.	"	5th	"	"	15
No. 327	118	"	Htg.	Nickel	10th	Lever	"	16
No. 328	118	"	"	"	"	"	"	17
No. 329	119	"	"	"	"	"	"	17
No. 330	119	"	"	"	"	"	"	21
No. 331	120	"	O. F.	"	11th	Pend.	"	16
No. 332	120	"	"	"	"	"	"	17
No. 333	121	"	"	"	"	Lever	"	17
No. 334	121	"	"	"	"	"	"	21
No. 335	105	"	Htg.	"	4th	"	"	17
No. 336	106	16	3/4 Pl. Htg. Br.	"	5th	Pend.	"	17
No. 337	33	"	O. F. Br.	"	6th	"	"	17
No. 338	38	"	O. F. Br.	"	7th	"	"	17
No. 339	107	"	Htg. Br.	"	6th	"	"	17
No. 340	109	"	O. F. Br.	"	7th	"	"	17
No. 341	125	"	Htg. Br.	"	8th	Lever	"	17
No. 342	127	"	O. F. Br.	"	9th	"	"	17
No. 343	122	18	F. Pl. O. F.	"	7th	"	"	17
No. 344	113	12	3/4 Pl. Htg.	"	2d	Pend.	"	17
No. 345	114	"	O. F.	"	3d	"	"	17
No. 346	111	"	Htg.	"	2d	"	"	17

ELGIN NATIONAL WATCH CO.

Grades of Movements with Classification and Description as Originally Made.

Grade.	Class.	Size.	Style.	Model.	Sett.	Train.	Jewels.	
No. 347.	112	12	3/4 Pl. O. F.	Nickel	3d	Pend.	Quick	17
No. 348.	1	18	F. Pl. Htg.	"	2d to 4th	Lever	"	21
No. 349.	65	"	O. F.	"	7th	"	"	21
No. 350.	98	16	3/4 Pl.	"	13th	"	"	23
No. 351.	41	"	"	"	7th	Pend.	"	23
No. 352.	123	18	F. Pl. Htg.	"	2d to 4th	Lever	"	17
No. 353.	124	"	O. F.	"	7th	"	"	17
No. 354.	116	0	3/4 Pl. Htg.	"	2d	Pend.	"	15
No. 355.	117	"	O. F.	"	3d	"	"	15
No. 356.	128	14	"	"	2d	"	"	7
No. 357.	128	"	"	"	"	"	"	15
No. 358.	128	"	"	"	"	"	"	17
No. 359.	129	"	"	"	"	"	"	17
No. 360.	98	16	"	"	16th	Lever	"	21
No. 361.	102	"	"	"	"	"	"	17
No. 363.	113	12	Htg. Gilded	2d	Pend.	"	"	15
No. 364.	114	"	O. F.	3d	"	"	"	15
No. 365.	109	16	Htg.	6th	"	"	"	15
No. 366.	110	"	O. F.	7th	"	"	"	15
No. 367.	90	18	"	Nickel	8th	Lever	"	21
No. 368.	130	"	Htg.	9th	"	"	"	17
No. 369.	131	"	O. F.	8th	"	"	"	17
No. 370.	102	16	"	"	15th	"	"	17
No. 371.	126	"	Htg.	14th	"	"	"	19
No. 372.	98	"	O. F.	15th	"	"	"	19
No. 373.	126	"	Htg.	14th	"	"	"	21
No. 374.	98	"	O. F.	15th	"	"	"	21
No. 375.	98	"	"	"	"	"	"	21
No. 376.	132	"	"	"	"	"	"	23
No. 377.	116	0	Htg.	Gilded	2d	Pend.	"	15
No. 378.	105	18	F. Pl. Nickel	2d to 4th	Lever	"	"	17
No. 379.	106	"	O. F.	5th	Pend.	"	"	17
No. 380.	133	5/0	3/4 Pl. Htg.	1st	"	"	"	15
No. 381.	107	16	Htg. Br.	6th	"	"	"	17
No. 382.	108	"	O. F. Br.	7th	"	"	"	17
No. 383.	113	12	Htg.	2d	"	"	"	17
No. 384.	114	"	O. F.	3d	"	"	"	17
No. 385.	134	18	"	8th	Lever	"	"	17
No. 386.	109	16	Htg.	6th	Pend.	"	"	17
No. 387.	110	"	O. F.	7th	"	"	"	17
No. 388.	98	"	"	15th	Lever	"	"	21
No. 389.	134	18	"	8th	"	"	"	21
No. 390.	91	"	"	"	"	"	"	21
No. 391.	98	16	"	"	"	"	"	21
No. 392.	125	12	"	15th	"	"	"	17
No. 393.	113	"	Htg.	Gilded	2d	"	"	7
No. 394.	114	"	O. F.	3d	"	"	"	7
No. 395.	113	"	Htg.	2d	"	"	"	15
No. 396.	114	"	O. F.	3d	"	"	"	15
No. 397.	33	16	Htg. Br.	Nickel	6th	"	"	17
No. 398.	38	"	O. F. Br.	"	7th	"	"	17
No. 399.	136	5/0	O. F.	"	2d	"	"	15
No. 400.	131	18	"	"	8th	Lever	"	17
No. 401.	126	16	Htg.	"	17th	"	"	19
No. 402.	126	"	"	"	"	"	"	21
No. 403.	133	5/0	"	"	1st	Pend.	"	7
No. 404.	97	10/0	O. F.	"	"	"	"	15
No. 405.	96	"	"	"	"	"	"	17
No. 406.	116	0	Htg.	Gilded	2d	"	"	13
No. 407.	135	12	O. F.	Nickel	4th	"	"	21
No. 408.	133	5/0	Htg.	"	1st	"	"	15
No. 409.	117	0	O. F.	Gilded	3d	"	"	7
No. 410.	117	"	"	"	"	"	"	15
No. 411.	106	18	F. Pl. Nickel	"	5th	"	"	21
No. 412.	91	3/4 Pl.	"	"	8th	Lever	"	21
No. 413.	116	3/0	Htg.	"	2d	"	"	7
No. 414.	117	"	O. F.	"	2d	Pend.	"	7
No. 415.	116	"	Htg.	"	2d	"	"	15
No. 416.	117	"	O. F.	"	3d	"	"	15

Read the introduction page carefully as it explains fully our system of cataloging.

MODELS OF MOVEMENTS

18 Size, 1st Model

Full Plate

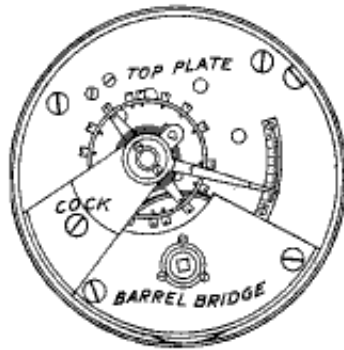

Hunting, Key Winding and Setting

18 Size, 2d to 4th Model

Full Plate

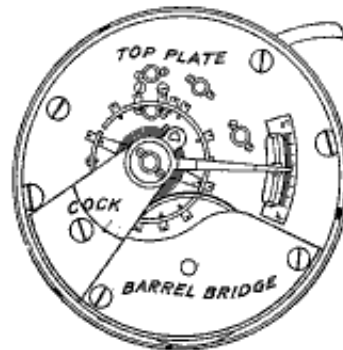

Hunting, Lever Setting

18 Size, 5th Model

Full Plate

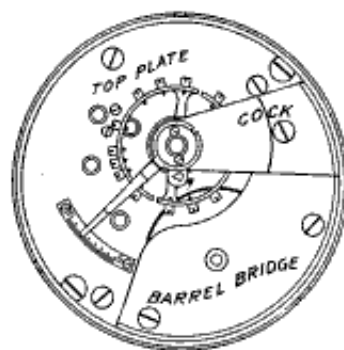

Open Face, Pendant Setting

18 Size, 6th Model

Three-Quarter Plate

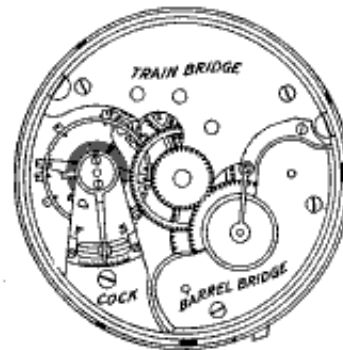

Hunting and Open Face, Pendant Setting

18 Size, 7th Model

Full Plate

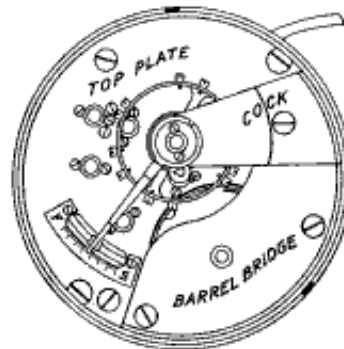

Open Face, Lever Setting

18 Size, 8th Model

Three-Quarter Plate

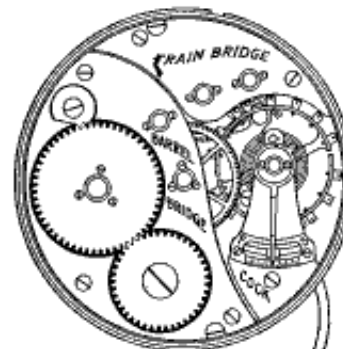

Open Face, Lever Setting

MODELS OF MOVEMENTS—Continued

18 Size, 8th Model
Three-Quarter Plate

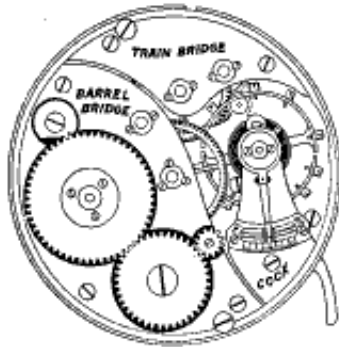

Open Face, Lever Setting with Winding Indicator

18 Size, 9th Model
Three-Quarter Plate



Hunting, Lever Setting

18 Size, 9th Model
Three-Quarter Plate



Hunting, Lever Setting with Winding Indicator

17 Size, 1st Model
Full Plate

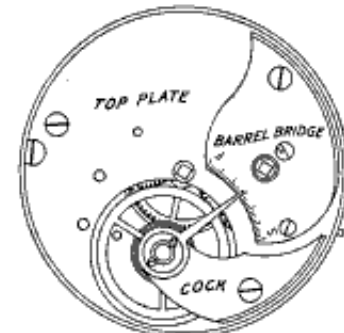

Hunting, Key Winding and Setting

17 Size, 2d Model
Full Plate

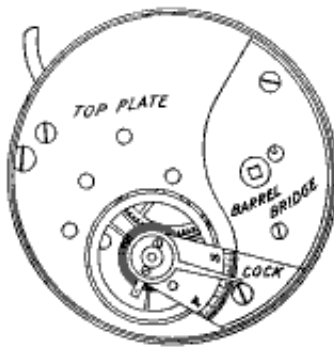

Hunting, Lever Setting

16 Size, 1st Model
Three-Quarter Plate

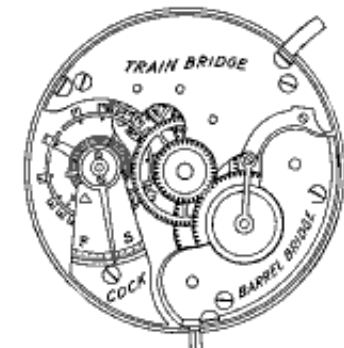

Hunting and Open Face, Lever Setting

MODELS OF MOVEMENTS—Continued

16 Size, 2d Model
Three-Quarter Plate, Bridge

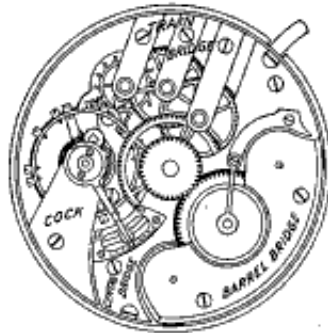

Hunting and Open Face, Lever Setting

16 Size, 3d Model
Three-Quarter Plate

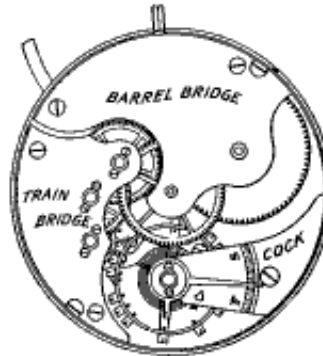

Hunting, Lever Setting

16 Size, 4th Model
Three-Quarter Plate

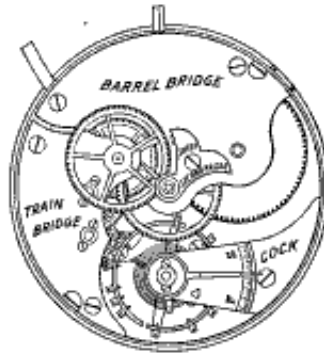

Sweep Second, Hunting and Open Face, Lever Setting

16 Size, 5th Model
Three-Quarter Plate

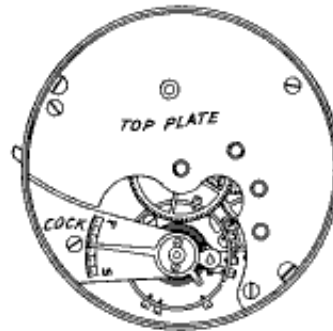

Open Face, Pendant Setting

16 Size, 5th Model
Three-Quarter Plate

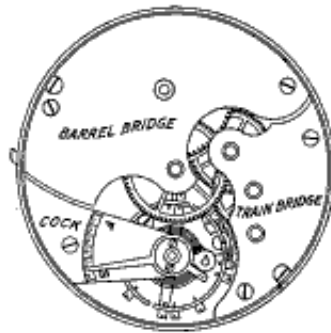

Open Face, Pendant Setting

16 Size, 6th Model
Three-Quarter Plate

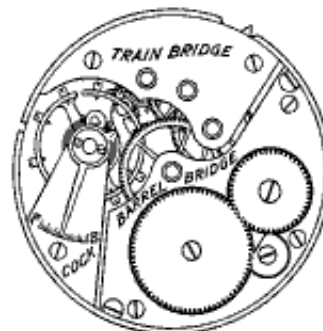

Hunting, Pendant Setting

MODELS OF MOVEMENTS—Continued

16 Size, 6th Model
Three-Quarter Plate, Bridge

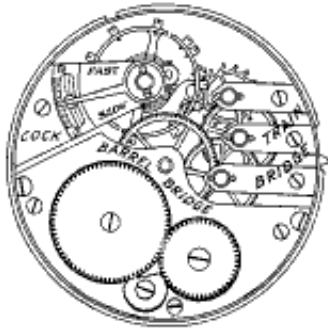

Hunting, Pendant Setting

16 Size, 7th Model
Three-Quarter Plate

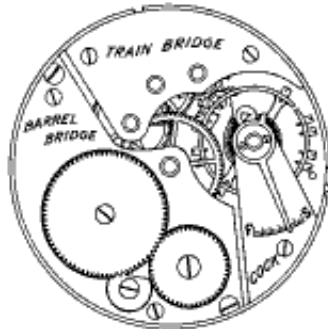

Open Face, Pendant Setting

16 Size, 7th Model
Three-Quarter Plate, Bridge

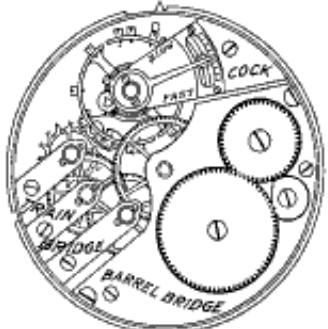

Open Face, Pendant Setting

16 Size, 8th Model
Three-Quarter Plate, Bridge

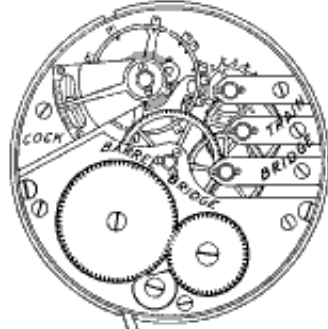

Hunting, Lever Setting

16 Size, 9th Model
Three-Quarter Plate, Bridge

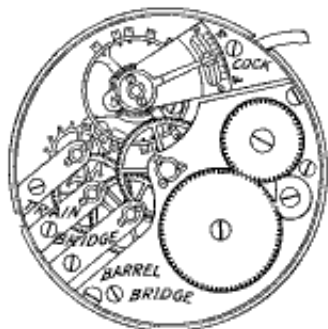

Open Face, Lever Setting

16 Size, 13th Model
Three-Quarter Plate

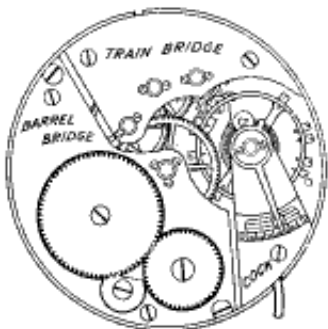

Open Face, Lever Setting

MODELS OF MOVEMENTS—Continued

16 Size, 14th Model
Three-Quarter Plate

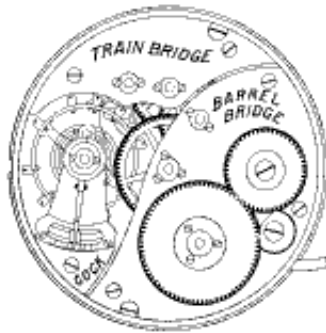

Hunting, Lever Setting

16 Size, 15th Model
Three-Quarter Plate



Open Face, Lever Setting

16 Size, 17th Model
Three-Quarter Plate

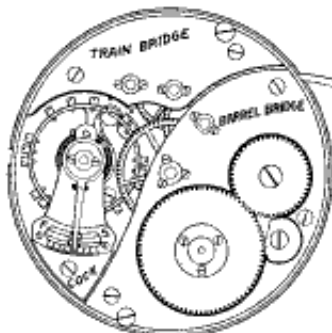

Hunting, Lever Setting

16 Size, 19th Model
Three-Quarter Plate

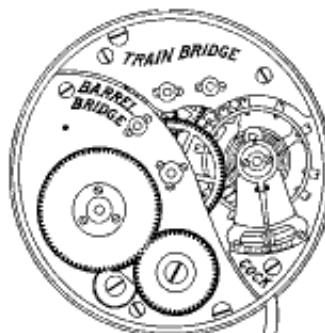

Open Face, Lever Setting with Winding Indicator

14 Size, 1st Model
Three-Quarter Plate

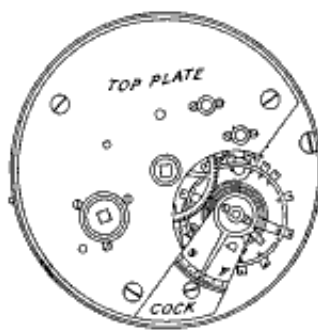

Hunting, Key Winding and Setting

14 Size, 2d Model
Three-Quarter Plate

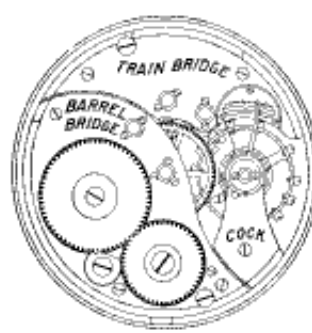

Open Face, Pendant Setting

MODELS OF MOVEMENTS—Continued

12 Size, 1st Model
Three-Quarter Plate

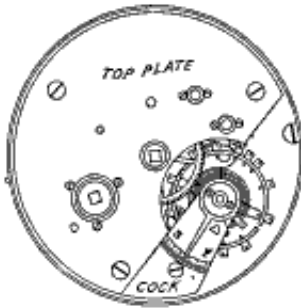

Hunting, Key Winding and Setting

12 Size, 2d Model
Three-Quarter Plate

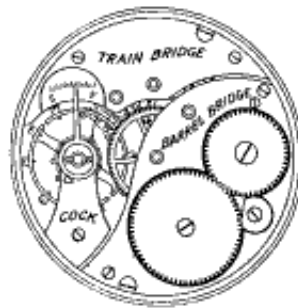

Hunting, Pendant Setting

12 Size, 2d Model, $\frac{3}{4}$ Plate
Spread to 16 Size

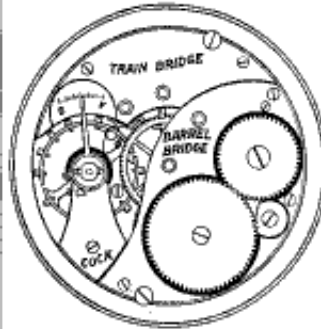

Hunting, Pendant Setting

12 Size, 3d Model
Three-Quarter Plate

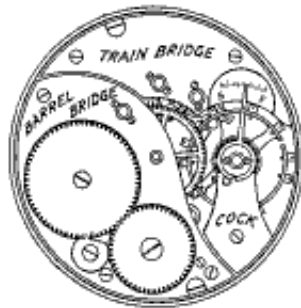

Open Face, Pendant Setting

12 Size, 3d Model, $\frac{3}{4}$ Plate
Spread to 16 Size

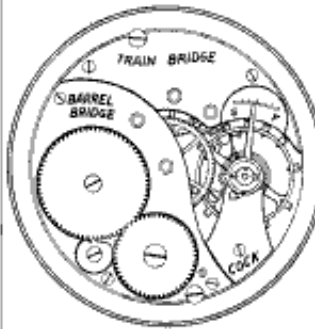

Open Face, Pendant Setting

12 Size, 4th Model
Three-Quarter Plate

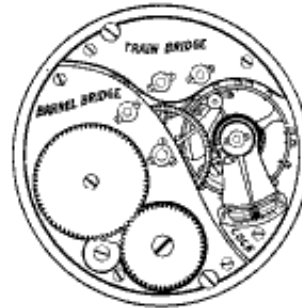

Open Face, Pendant Setting

10 Size, 1st Model
Three-Quarter Plate, Style 1

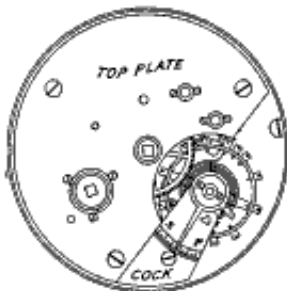

Hunting, Key Winding and Setting

10 Size, 1st Model
Three-Quarter Plate, Style 2

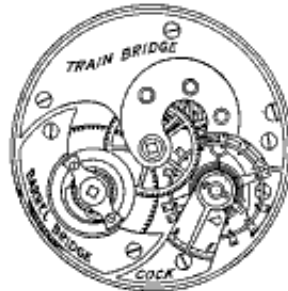

Hunting, Key Winding and Setting

10 Size, 1st Model
Three-Quarter Plate, Style 3

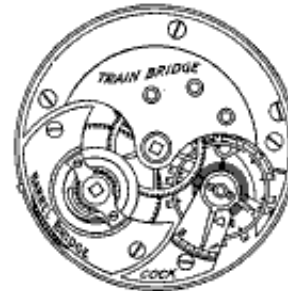

Hunting, Key Winding and Setting

MODELS OF MOVEMENTS—Continued

10 Size, 1st Model
Three-Quarter Plate, Style 4

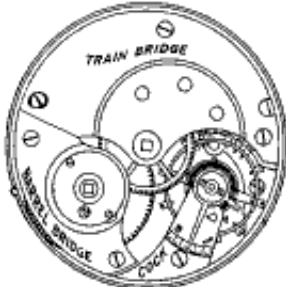

Hunting, Key Winding and Setting

6 Size, 1st Model
Three-Quarter Plate

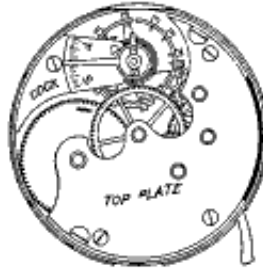

Hunting, Lever Setting

6 Size, 1st Model
Three-Quarter Plate

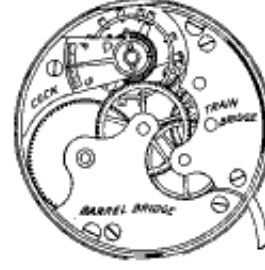

Hunting, Lever Setting

6 Size, 2d Model
Three-Quarter Plate

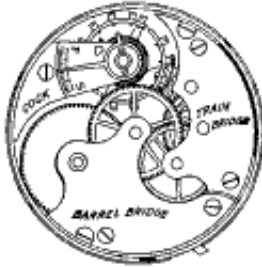

Hunting, Pendant Setting

6 Size, 1st Model
Three-Quarter Plate



Hunting, Pendant Setting

6 Size, 2d Model
Three-Quarter Plate



Hunting, Pendant Setting

9 Size, 2d Model, $\frac{3}{4}$ Plate
Spread to 12 Size

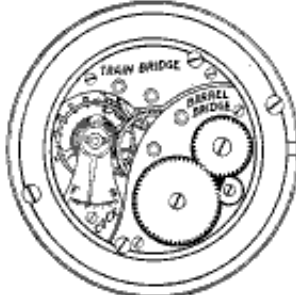

Hunting, Pendant Setting

9 Size, 3d Model
Three-Quarter Plate



Open Face, Pendant Setting

9 Size, 3d Model, $\frac{3}{4}$ Plate
Spread to 12 Size

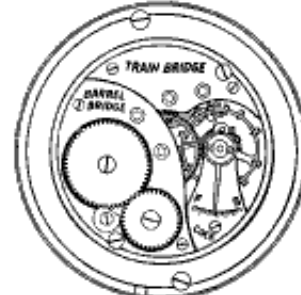

Open Face, Pendant Setting

3-0 Size, 2d Model
Three-Quarter Plate



Hunting, Pendant Setting

3-0 Size, 3d Model
Three-Quarter Plate

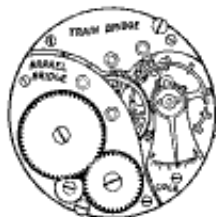

Open Face, Pendant Setting

5-0 Size, 1st Model
Three-Quarter, Plate



Hunting, Pendant Setting

MODELS OF MOVEMENTS—Continued

5-0 Size, 2d Model
Three-Quarter Plate



Open Face, Pendant Setting

10-0 Size, 1st Model
Three-Quarter Plate

























Open Face, Pendant Setting

CLASSES OF MATERIAL AND THE GRADES OF MOVEMENTS TO WHICH
THEY ARE APPLIED.

Class	Grades	Class	Grades	Class	Grades	Class	Grades
1	Raymond, Father Time (Htg., Lever Set.) 27, 69, 70, 149, 164, 183, 348.	28	No. 89.	66	Overland, (O. F., Lever Set.) 265, 283.	105	No. 287, 296, 309, 316, 335, 378.
2	Culver, (Htg., Lever Set.) 61, 62.	29	No. 107, 108.	67	No. 190.	106	No. 288, 294, 297, 317, 326, 336, 379, 411.
3	Taylor, Overland (Htg., Lever Set.) 20, 33, 38, 58, 79, 80, 163.	30	No. 106, 140.	68	No. 189, 236.	107	No. 305, 339, 351.
4	Wheeler, Overland, (Htg., Lever Set.) Luffin, Ferry, Ryerson, 16, 17, 56, 57, 63, 81, 82, 103, 126, 126, 143, 144, 278.	31	No. 104, 105, 128, 138, 139, 182, 193.	69	No. 188.	108	No. 306, 340, 382.
5	Ogden, Farwell, Fargo, Advance, Chief, Age, 5, 8, 9, 10, 12, 13, 18, 19, 55, 60, 68, 78, 87, 88, 102, 141, 142, 169, 226, 228.	32	No. 155, 243.	70	No. 187, 196.	109	No. 290, 292, 296, 312, 363, 386, 387.
6	No. 6, 7, 96, 97, 171.	33	Wheeler, (Htg., Pend. Set.) 154, 241, 242, 337, 397.	71	No. 194.	110	No. 291, 293, 300, 313, 366.
7	Raymond, Father Time (O. F., Pend. Set.) 77, 116, 150, 166, 184.	34	No. 153.	72	No. 183, 237.	111	Wheeler, (Htg., Pend. Set.) 321, 346.
8	Taylor, Overland, (O. F., Pend. Set.) 76, 165.	35	No. 151, 152, 185.	73	No. 192.	112	Wheeler, (O. F., Pend. Set.) 322, 347.
9	Wheeler, Overland, (O. F., Pend. Set.) 44, 75, 123, 124, 147, 148, 279.	36	No. 156.	74	No. 191, 197.	113	No. 301, 302, 310, 314, 344, 363, 363, 393, 395.
10	No. 43, 74, 145, 146, 170, 227, 229.	37	No. 161, 246.	75	No. 206, 209, 216, 284.	114	No. 303, 304, 311, 315, 345, 364, 364, 394, 396.
11	No. 73, 172.	38	Wheeler, (O. F., Pend. Set.) 160, 243, 245, 338, 398.	76	No. 201.	115	No. 296, 318, 320, 323.
12	No. 100.	39	No. 159.	77	No. 200, 263.	116	354, 377, 406, 413, 415.
13	No. 99.	40	No. 157, 158, 186.	78	No. 199.	117	No. 319, 324, 355, 409, 410, 414, 416.
14	No. 98.	41	Lord Elgin, 162, 351.	79	No. 198.	118	Special.
15	Avery, Leader, 11, 14, 15, 51, 52, 59.	42	No. 37, 41, 42, 46.	80	No. 205.	119	Special.
16	No. 72.	43	No. 34, 35, 36, 39, 40.	81	No. 204, 264.	120	Special.
17	No. 49, 50.	44	No. 26, 32.	82	No. 203.	121	Special.
18	No. 48.	45	No. 24, 25, 30, 31.	83	No. 202.	122	No. 343.
19	No. 47.	46	Frances Robie.	84	No. 219, 222, 223.	123	Wheeler, (Htg., Lever Set.) 352.
20	No. 93.	47	Lady Elgin (Key Wind) 28, 29.	85	No. 224, 267, 269, 281.	124	Wheeler, (O. F., Lever Set.) 353.
21	No. 91.	48	Gail Borden, Dexter St. 21, 22, 28, 53, 54.	86	No. 225, 268, 282.	125	Raymond, (Htg., Lever Set.) 341.
22	No. 85, 86.	49	No. 71.	87	No. 232, 233, 253, 259.	126	Father Time, Raymond (Htg., Lever Set.) 371.
23	No. 90.	50	No. 66, 67.	88	No. 234, 235, 254, 260.	127	No. 342.
24	No. 3, 4.	51	No. 43, 64, 65.	89	Veritas, (O. F., Lever Set.) 214.	128	No. 356, 357, 358.
25	No. 1, 2, 137.	52	No. 94, 95, 101.	90	Veritas, (O. F., Lever Set.) 214.	129	No. 359.
26	No. 92, 114, 127, 135, 136.	53	No. 122, 176.	91	Father Time, Veritas, (O. F., Lever Set.) 239, 367.	130	Wheeler, (Htg., Lever Set.) 368.
27	No. 83, 84.	54	No. 121, 134, 168.	92	Raymond, (3/4 Pl., O. F. Lever Set.) 240, 390, 412.	131	Wheeler, (O. F., Lever Set.) 369, 400.
		55	No. 120.	93	No. 210, 212, 220, 257.	132	Veritas, (O. F., Lever Set.) 376.
		56	No. 117, 118, 119, 132, 133, 175, 230, 231, 272.	94	No. 247.	133	Lady Elgin, 380, 403, 408.
		57	No. 112, 174.	95	No. 211, 213, 221, 258.	134	No. 385, 389.
		58	No. 111, 131, 167.	96	No. 248.	135	No. 392, 407.
		59	No. 115.	97	Lady Elgin (O. F., Pend. Set.) 253, 404.	136	No. 399.
		60	No. 109, 110, 113, 129, 130, 173, 271.	98	Father Time, Raymond Veritas, (O. F., Lever Set.) 270, 350, 360, 372, 374, 375, 388, 391.		
		61	No. 207, 217, 238, 251, 261.	99	Veritas, (Htg., Lever Set.) 274.		
		62	No. 249.	100	No. 275.		
		63	No. 208, 215, 218, 262, 285.	101	No. 276.		
		64	No. 250.	102	Raymond, (O. F., Lever Set.) 280, 361, 370.		
		65	Raymond, Father Time (O. F., Lever Set.) 180, 181, 252, 266, 273, 277, 349.	103	No. 307.		
				104	No. 308.		

ARBORS, BARREL

Catalogue No.	CLASS	PRICE		DESCRIPTION OF MOVEMENT			
		Piece	Per Doz.	Size	Model		
188	1 to 4	.40	4.00	18	F. Pl.	1st to 4th	For Stop Works
188	5, 6, 61	.35	3.50	"	"	"	
189	1 to 5, 7, 65	.40	4.00	"	"	2d to 5th, 7th	For Stop Works
190	1, 4, 8, 9, 65, 66, 118 to 121	.35	3.50	"	"	2d to 5th, 7th, 10th, 11th	
190	5, 6, 10, 11, 61 to 64, 103 to 106, 122 to 124	.30	3.00	"	"	2d to 5th, 7th	For Stop Works
197	17 to 14	.45	4.50	"	1/2 Pl.	6th	
1757	89 to 91, 99	.40	4.00	"	"	8th, 9th	For Stop Works
2548	134	.40	4.00	"	"	8th	
2548	130, 131	.35	3.50	"	"	8th, 9th	For Stop Works
194	15	.35	3.50	17	F. Pl.	1st	
195	15	.35	3.50	"	"	2d	For Stop Works
196	16, 21	.50	6.00	16	1/2 Pl.	1st, 2d	
197	17 to 20, 22, 23	.45	4.50	"	"	"	For Stop Works
200	24, 25, 27 to 30	.50	4.00	"	"	3d to 5th	
200	29, 31	.35	3.50	"	"	3d, 5th	For Stop Works
1301	32 to 34, 36 to 39, 41, 98, 102, 125	.40	4.00	"	"	6th to 9th, 13th, 15th	
1301	35, 40, 92 to 95, 107 to 110, 127	.35	3.50	"	"	6th, 7th, 9th	For Stop Works
1302	36, 41	.45	4.50	"	"	6th, 7th	
2549	41, 98, 102, 126, 132	.40	4.00	"	"	7th, 9th, 14th, 15th, 17th	For Stop Works
203	42, 43	.40	4.00	14	"	1st	
1715	128, 129	.35	3.50	"	"	2d	For Stop Works
206	44, 45	.40	4.00	12	"	1st	
1758	67 to 69, 71 to 73	.40	4.00	"	"	2d, 3d	For Stop Works
1758	70, 74	.35	3.50	"	"	"	
1715	87, 88, 100, 101, 111 to 114	.35	3.50	"	"	"	For Stop Works
2732	135	.40	4.00	"	"	4th	
205	46 to 48	.40	4.00	10	"	1st	For Stop Works
206	49 to 51, 53 to 55	.40	4.00	6	"	1st, 2d	
206	52, 56, 75, 115	.35	3.50	"	"	"	For Stop Works
207	57 to 59	.40	4.00	0	"	1st	
207	60, 84	.35	3.50	"	"	"	For Stop Works
1759	76, 77, 80, 81	.40	4.00	"	"	2d, 3d	
1759	78, 79, 82, 83, 85, 86	.35	3.50	"	"	"	For Stop Works
2053	77, 81	.40	4.00	"	"	"	
2053	85, 86, 116, 117	.35	3.50	"	"	"	For Stop Works
1760	133, 136	.35	3.50	5/0	"	1st, 2d	
1760	96, 97	.35	3.50	10/0	"	1st	

























 No. 188 Htg.	 No. 189 Htg. or O. F.	 No. 190 Htg. or O. F.	 No. 194 Htg.	 No. 195 Htg.
 No. 196 Htg. or O. F.	 No. 197 Htg. or O. F.	 No. 200 Htg. or O. F.	 No. 203 Htg.	 No. 205 Htg.
 No. 206 Htg.	 No. 207 Htg.	 No. 1301 Htg. or O. F.	 No. 1302 Htg. or O. F.	 No. 1715 Htg. or O. F.
 No. 1757 Htg. or O. F.	 No. 1758 Htg. or O. F.	 No. 1759 Htg. or O. F.	 No. 1760 Htg. or O. F.	 No. 2053 Htg. or O. F.
	 No. 2548 Htg. or O. F.	 No. 2549 Htg. or O. F.	 No. 2732 O. F.	

Barrel Arbors, Catalogue No. 188, classified as 1 to 4 and 5 to 6, were made with Key Squares, and used in the first Key and Lever Setting Movements. Stop Works were used with classes 1 and 2, Catalogue No. 188, also with classes 1, 2, 7 and 65, Catalogue No. 189.

No. 190 is now made like illustration  and can be used in place of the original 190.

ARBORS, PALLET

Catalogue No.	CLASS	PRICE		DESCRIPTION OF MOVEMENT			
		Piece	Per Doz.	Size	Model		
1303	1, 7, 65, 119, 121	.50	5.00	18	F. Pl.	2d to 5th, 7th, 10th, 11th	Cone Pivot
5	1 to 4, 7 to 9, 63, 66, 118 to 121	.25	2.50	"	"	1st to 5th, 7th, 10th, 11th	Straight Pivot
208	103 to 106, 123 to 124	.20	2.00	"	"	2d to 5th, 7th	"
208	5, 6, 10, 11, 61 to 64	.15	1.50	"	"	1st to 5th	"
1762	89, 90, 91, 99, 134	.50	5.00	"	5/8 PL	8th, 9th	Cone Pivot
1763	91, 130, 131, 134	.25	2.50	"	"	"	Straight Pivot
214	12, 13	.25	2.50	"	"	6th	"
215	14	.15	1.50	"	"	"	"
* 213	15	.15	1.50	17	F. Pl.	1st, 2d	"
1304	16, 21, 36, 41, 98	.50	5.00	16	5/8 PL	1st, 2d, 6th, 7th, 9th	Cone Pivot
1304	126, 132	.50	5.00	"	"	13th to 15th, 17th	"
214	17 to 19, 22 to 25, 27 to 30, 32 to 34, 37 to 39	.25	2.50	"	"	1st to 7th	Straight Pivot
214	98, 102, 107, 108, 125, 126	.25	2.50	"	"	6th to 8th, 13th to 15th, 17th	"
215	20, 29, 31, 35, 40, 92 to 95	.15	1.50	"	"	1st, 3d, 5th to 7th	"
*1765	31, 35, 40, 92 to 95	.15	1.50	"	"	5th to 7th	"
2309	31, 109, 110, 127	.20	2.00	"	"	6th, 7th, 9th	"
223	42, 43	.25	2.50	14	"	1st	"
2310	128, 129	.20	2.00	"	"	2d	"
223	44, 45	.25	2.50	12	"	1st	"
1761	67, 68, 71, 72	.50	5.00	"	"	2d, 3d	Cone Pivot
2631	67, 71, 135	.50	5.00	"	"	2d to 4th	"
1766	68, 69, 72, 73	.25	2.50	"	"	2d, 3d	Straight Pivot
1766	70, 74, 87, 88, 100, 101	.15	1.50	"	"	"	"
*1767	70, 74, 87, 88, 100, 101	.15	1.50	"	"	"	"
2310	111 to 114	.20	2.00	"	"	"	"
2733	135	.20	2.00	"	"	4th	"
223	46 to 48	.25	2.50	10	"	1st	"
224	49, 50, 63, 64	.25	2.50	6	"	1st, 2d	"
225	51, 53	.20	2.00	"	"	"	"
225	52, 56, 75	.15	1.50	"	"	"	"
2311	115	.20	2.00	"	"	2d	"
*1769	56, 75	.15	1.50	"	"	"	"
226	57, 58	.25	2.50	0	"	1st	"
227	59	.20	2.00	"	"	"	"
227	60	.15	1.50	"	"	"	"
1723	76, 77, 80, 81	.25	2.50	"	"	2d, 3d	"
1723	78, 79, 82 to 86	.15	1.50	"	"	1st to 3d	"
2312	77, 81	.25	2.50	"	"	2d, 3d	"
2312	116, 117	.20	2.00	"	"	"	"
*1770	78, 79, 82 to 86	.15	1.50	"	"	1st to 3d	"
2550	133, 136	.30	3.00	5/0	"	1st, 2d	"
*1771	96, 97	.30	3.00	10/0	"	1st	"
2550	96, 97	.30	3.00	"	"	"	"

No. 5  Htg. or O. F.	No. 208  Htg. or O. F.	No. 213  Htg.	No. 214  Htg. or O. F.	No. 215, 2309  Htg. or O. F.	No. 223  Htg.
No. 224  Htg.	No. 225, 2311  Htg.	No. 226  Htg.	No. 227, 2312  Htg. or O. F.	No. 1303  Htg. or O. F.	No. 1304  Htg. or O. F.
No. 1723  Htg. or O. F.	No. 1761  Htg. or O. F.	No. 1762  Htg. or O. F.	No. 1763  Htg. or O. F.	No. 1765  Htg. or O. F.	No. 766, 2310 2631  Htg. or O. F.
No. 1767  Htg. or O. F.	No. 1769  Htg.	No. 1770  Htg. or O. F.	No. 1771  O. F.	No. 2550  Htg. or O. F.	No. 2733  O. F.

*These arbors are made to fit pallet friction tight. In many of the classes both screw and friction arbors have been used and care should be taken to give correct number.

Screw Pallet Arbors with two different diameters of threads have been used in 16 Size, Class 31—Nos. 214 and 215 have large diameter, and 2309 small diameter. In 0 size, classes 77 and 81, No. 1723 has large diameter thread and 2312 small.

ARBORS, SETTING

Catalogue No.	Class	PRICE		DESCRIPTION OF MOVEMENT	
		Piece	Per Doz.	Size	Model
* 189	12 to 14.....	.35	3 50	18	3/4 Pl. 6th
228	15.....	.20	2 00	17	F. Pl. 1st
* 95	16, 17, 19 to 23.....	.35	3 50	16	3/4 Pl. 1st, 2d
230	42, 43.....	.20	2 00	14	" "
231	44, 45.....	.20	2 00	12	" "
231	46 to 48.....	.20	2 00	10	" "

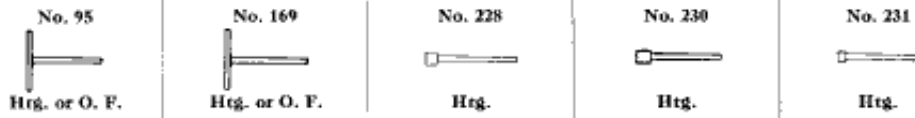

*These arbors are furnished with Setting Wheels.

ARBORS, SWEEP SECOND

Catalogue No.	Class	PRICE		DESCRIPTION OF MOVEMENT	
		Piece	Per Doz.	Size	Model
232	27, 28.....	.20	2 00	16	3/4 Pl. 4th



ARBORS, WINDING

Catalogue No.	Class	PRICE		DESCRIPTION OF MOVEMENT	
		Piece	Per Doz.	Size	Model
1772	89 to 91, 99, 134.....	.50	5 00	18	3/4 Pl. 8th, 9th
1772	130, 131.....	.40	4 00	"	" "
1305	32, 33, 36 to 38, 41.....	.50	5 00	16	" 6th, 7th
1305	34, 35, 39, 40.....	.40	4 00	"	" "
1773	32 to 41.....	.25	2 50	"	" "
1773	92 to 95, 107 to 110.....	.20	2 00	"	" "
2052	98, 102, 125 to 127, 132.....	.50	5 00	"	8th, 9th, 13th to 15th, 17th
1774	128, 129.....	.20	2 00	14	" 2d
1774	67 to 74.....	.25	2 50	12	" 2d, 3d
1774	87, 88, 100, 101, 111 to 114.....	.20	2 00	"	" "
2734	135.....	.25	2 50	"	" 4th
1775	76 to 83.....	.25	2 50	0	" 2d, 3d
1775	85, 86, 116, 117.....	.20	2 00	"	" "
2551	133, 136.....	.25	2 50	5/0	" 1st, 2d
1776	96, 97.....	.25	2 50	10/0	" 1st

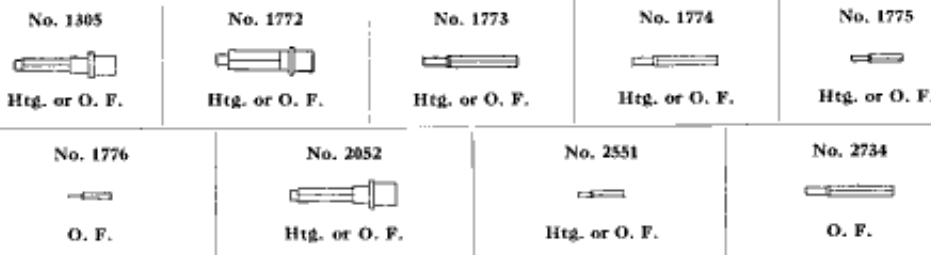

Orders for less than one-fourth dozen will be charged at single piece price.

ARMS, VIBRATING

Catalogue No.	Class	PRICE		DESCRIPTION OF MOVEMENT		
		Piece	Per Doz.	Size	Model	
35	1.....	35	3.50	18	F. Pl.	2d to 4th
35	2 to 5.....	25	2.50	"	"	"
35	119.....	20	2.00	"	"	10th
64	6.....	20	2.00	"	"	2d to 4th
1735	61, 62, 103, 105, 123.....	20	2.00	"	"	"
55	4, 5.....	25	2.50	"	"	"
1777	4, 5, 118.....	25	2.50	"	"	2d to 4th, 10th
172	7.....	35	3.50	"	"	5th
172	8, 9.....	25	2.50	"	"	"
172	10, 11, 120.....	20	2.00	"	"	5th, 11th
1730	63, 64.....	20	2.00	"	"	5th
1737	63, 64, 104, 106.....	20	2.00	"	"	"
1778	65.....	35	3.50	"	"	7th
1778	66.....	25	2.50	"	"	"
1778	121, 122, 124.....	20	2.00	"	"	7th, 11th
76	15.....	20	2.00	17	"	2d
133	24, 25, 27, 28.....	25	2.50	16	3/4 Pl.	2d, 4th
134	26.....	20	2.00	"	"	3d
233	29, 30.....	25	2.50	"	"	5th
233	31.....	20	2.00	"	"	"
106	49 to 51.....	25	2.50	6	"	1st
152	52.....	20	2.00	"	"	"
1306	53 to 55.....	25	2.50	"	"	2d
1306	56.....	20	2.00	"	"	"
1307	53 to 55.....	25	2.50	"	"	"
1307	56.....	20	2.00	"	"	"
2101	75, 115.....	20	2.00	"	"	"
235	57 to 59.....	25	2.50	0	"	1st
235	60.....	20	2.00	"	"	"
1732	84.....	20	2.00	"	"	"

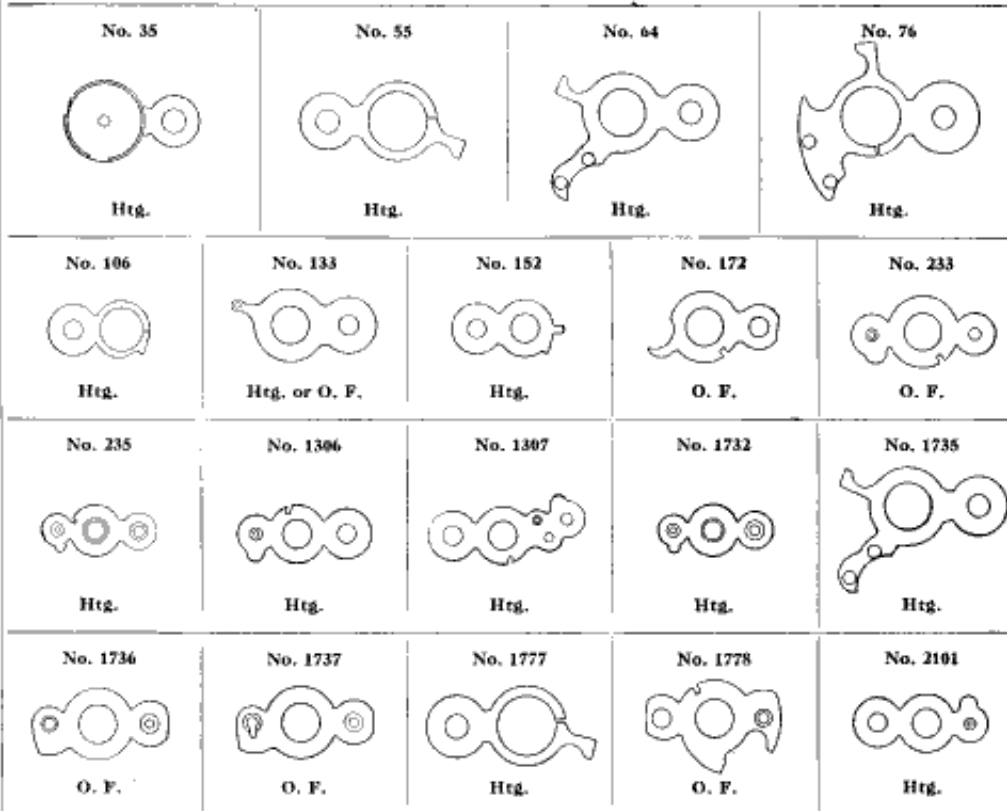

Orders for less than one-fourth dozen pieces of a kind will be charged at the single piece price.

BALANCES

Catalogue No.	CLASS	PRICE		DESCRIPTION OF MOVEMENT			
		Piece	Per Doz.	Size	Model		
236	1, 2, 7, 65	2.00	24.00	18	F. Pl.	1st to 5th, 7th	Compensating
238	3 to 5, 8 to 10, 62, 64, 66, 103, 104, 123, 124	1.25	15.00	"	"	"	"
236	6, 11, 105, 106, 122	.75	9.00	"	"	"	"
236	61, 63	.60	7.00	"	"	"	"
237	4, 5	.45	4.50	"	"	1st	Steel
238	5	.30	3.00	"	"	1st to 4th	Nickel
2521	119, 121	2.00	24.00	"	"	10th, 11th	Compensating
2521	118, 120	1.25	15.00	"	"	"	"
242	12, 14	1.25	15.00	"	3/4 Pl.	6th	"
1779	89, 90, 99	2.50	30.00	"	"	8th, 9th	"
1779	91	2.00	24.00	"	"	8th	"
236	134	2.00	24.00	"	"	"	"
236	130, 131	1.25	15.00	"	"	8th, 9th	"
241	15	.80	3.00	17	F. Pl.	1st, 2d	Nickel
242	16, 21, 36, 41, 132	2.50	30.00	16	3/4 Pl.	1st, 2d, 6th, 7th, 15th	Compensating
242	17, 22, 32, 37, 98, 102, 125, 126	2.00	24.00	"	"	1st, 2d, 6th, to 9th 13th to 15th, 17th	"
242	18, 19, 23 to 25, 27 to 30, 33, 34, 38, 39, 107, 108	1.25	15.00	"	"	1st to 7th	"
242	20, 26, 31, 35, 40, 93, 95, 109, 110, 127	.75	9.00	"	"	1st, 3d, 5th to 7th, 9th	"
242	92, 94	.60	7.00	"	"	6th, 7th	"
242	42	2.00	24.00	14	"	1st	"
242	43	1.25	15.00	"	"	"	"
1780	129	1.25	15.00	"	"	2d	"
1780	128	.75	9.00	"	"	"	"
248	44	2.00	24.00	12	"	1st	"
248	45	1.25	15.00	"	"	"	"
1780	67, 71	2.50	30.00	"	"	2d, 3d	"
1780	68, 72	2.00	24.00	"	"	"	"
1780	69, 73, 100, 101, 111, 112	1.25	15.00	"	"	"	"
1780	70, 74, 113, 114	.75	9.00	"	"	"	"
1780	87, 88	.60	7.00	"	"	"	"
2735	135	2.50	30.00	"	"	4th	"
248	46	2.00	24.00	10	"	1st	"
248	47, 48	1.25	15.00	"	"	"	"
249	49, 50, 53, 54	2.50	30.00	6	"	1st, 2d	"
249	51, 55	1.25	15.00	"	"	"	"
249	52, 56, 115	.75	9.00	"	"	"	"
249	75	.60	7.00	"	"	"	"
250	57, 58	2.50	30.00	0	"	1st	"
250	59	1.25	15.00	"	"	"	"
250	60	.75	9.00	"	"	"	"
1724	76, 77, 80, 81	2.50	30.00	"	"	2d, 3d	"
1724	78, 79, 82, 83, 116, 117	.75	9.00	"	"	"	"
1724	84 to 86	.60	7.00	"	"	1st to 3d	"
2552	133, 136	1.25	15.00	5/0	"	1st, 2d	"
1781	96	2.50	30.00	10/0	"	1st	"
1781	97	1.25	15.00	"	"	"	"

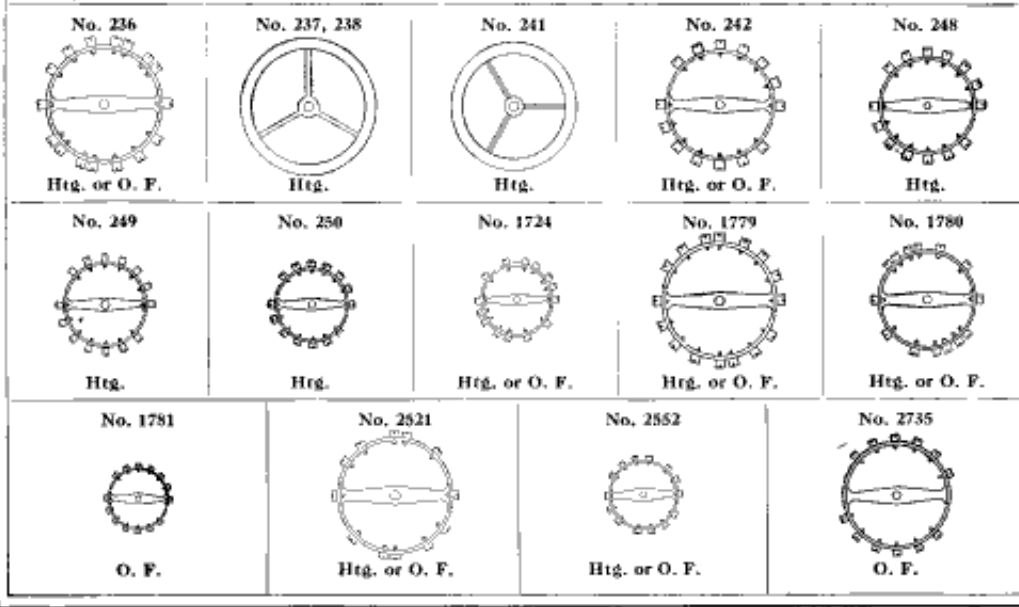

BANDS, DUST

Catalogue No.	CLASS	PRICE		DESCRIPTION OF MOVEMENT				
		Piece	Per Doz.	Size	Model			
255	6	15	1.50	18	F. Pl.	1st	Ring	Gilded
251	1 to 6, 61	10	.50	"	"	"	Slide	"
252	5	10	.50	"	"	"	"	Nickel
2131	1, 119	20	2.00	"	"	2d to 4th, 10th	Ring	"
2131	4, 5, 61, 105, 118, 123	15	1.50	"	"	"	"	"
256	6	15	1.50	"	"	2d to 4th	"	Gilded
2117	5, 61, 62, 103, 105	15	1.50	"	"	"	"	"
253	1 to 6	10	.50	"	"	"	Slide	"
254	1 to 6	10	.50	"	"	"	"	Nickel
2141	7, 65, 121, 122	20	2.00	"	"	5th, 7th, 11th	Ring	"
2141	9, 10, 63, 66, 106, 120, 124	15	1.50	"	"	"	"	"
2142	10, 63, 64, 104, 106	15	1.50	"	"	5th	"	Gilded
257	7 to 11	10	.50	"	"	"	Slide	"
258	7 to 11, 65, 66	10	.50	"	"	5th, 7th	"	Nickel
259	12 to 14	20	2.00	"	3/4 Pl.	6th	Ring	Gilded
1740	89 to 91, 131, 134	20	2.00	"	"	8th	"	Nickel
2140	99, 130	20	2.00	"	"	9th	"	"
262	15	15	1.50	17	F. Pl.	1st	"	Gilded
260	15	10	.50	"	"	"	Slide	"
263	15	15	1.50	"	"	2d	Ring	"
261	15	10	.50	"	"	"	Slide	"
1308	32 to 34, 36 to 39, 41, 98, 102, 125, 127	20	2.00	16	3/4 Pl.	6th to 9th, 13th	Ring	Nickel
1308	35, 40, 92 to 95, 107 to 110	15	1.50	"	"	6th, 7th	"	"
1539	35, 40, 92, 94, 109, 110	15	1.50	"	"	"	"	Gilded
2553	33, 125, 126	20	2.00	"	"	6th, 8th, 14th, 17th	"	Nickel
2553	107, 109	15	1.50	"	"	6th	"	"
2534	38, 41, 98, 102, 127, 132	20	2.00	"	"	7th, 9th, 13th, 15th	"	"
2554	108, 110	15	1.50	"	"	7th	"	"
2555	109	15	1.50	"	"	6th	"	Gilded
2556	110	15	1.50	"	"	7th	"	"
1882	67 to 69	20	2.00	12	"	2d	"	Nickel
1882	70, 87, 100, 111, 113	15	1.50	"	"	"	"	"
2098	87, 113	15	1.50	"	"	"	"	Gilded
2914	113	15	1.50	12x16	"	"	"	"
2143	71 to 73	20	2.00	12	"	3d	"	Nickel
2143	74, 88, 101, 112, 114	15	1.50	"	"	"	"	"
2144	87, 114	15	1.50	"	"	"	"	Gilded
2915	114	15	1.50	12x16	"	"	"	"
2736	135	20	2.00	12	"	4th	"	Nickel
1883	76, 77	20	2.00	0	"	2d	"	"
1883	78, 79, 85, 116	15	1.50	"	"	"	"	"
2114	116	15	1.50	"	"	"	"	Gilded
2145	80, 81	20	2.00	"	"	3d	"	Nickel
2145	82, 83, 86, 117	15	1.50	"	"	"	"	"
2913	117	15	1.50	"	"	"	"	Gilded

No. 251, 252



Htg.

No. 253, 254



Htg.

No. 257, 258



O. F.

No. 260



Htg.

No. 261



Htg.

The above illustrations represent bands or slides. All other illustrations are rings and represent their diameter, width and the shape of the sides.

No. 255, 356



Htg.

No. 259









Htg. or O. F.

No. 262, 263

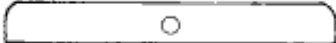

Htg.



BANDS, DUST—Continued

No. 1308, 1539  Htg. or O. F.	No. 1740, 2117, 2131, 2140, 2141, 2142  Htg. or O. F.
No. 1882, 2098, 2143, 2144  Htg. or O. F.	No. 1883, 2114, 2145, 2913  Htg. or O. F.
No. 2553, 2554, 2555, 2556  Htg. or O. F.	No. 2736  O. F.
No. 2914, 2915  Htg. or O. F.	

The illustrations shown above represent the diameter, width and shape of sides of Dust Rings.

BARS, SETTING

Catalogue No.	Class	PRICE		DESCRIPTION OF MOVEMENT		
		Piece	Per Doz.	Size	Model	
45	4, 5.....	.20	2.00	18	F. Pl.	2d to 4th,
45	118.....	.15	1.50	6	1/4 Pl.	10th
96	49 to 51.....	.20	2.00			1st

No. 45  Htg.	No. 96  Htg.
---	--

Your Jobber will supply Balance Staffs, Balance Jewels, Roller Jewels, Hands and Screws in Dozen lots in original Sealed Trade Marked Packages.



TRADE-MARKED PACKAGE



[TOP]

[BOTTOM]

BARRELS

Catalogue No.	CLASS	PRICE		DESCRIPTION OF MOVEMENT		Train	Material	Teeth
		Piece	Per Doz.	Size	Model			
* 264	1, 2, 7	.40	4.00	18	F. Pl. 1st to 5th	Quick	Gilded	78
265	3, 4, 8, 9	.35	3.50	"	" " " "	"	"	78
265	5, 6, 10, 11, 61 to 64, 103 to 106	.30	3.00	"	" " " "	"	"	78
266	3 to 6	.30	3.00	"	" " " "	"	"	60
* 267	1, 7, 65	.50	5.00	"	" " 1st to 4th	Slow	"	78
269	1, 3, 7, 8, 65, 66, 119, 121	.50	5.00	"	" " 2d to 5th, 7th	Quick	Nickel	78
269	4, 9, 118, 120	.45	4.50	"	" " 2d to 5th, 7th, 10th, 11th	"	"	78
269	5, 6, 10, 11, 61, 63, 105, 106, 122 to 124	.35	3.50	"	" " 2d to 5th, 7th	"	"	78
275	12 to 14	.40	4.00	"	" " 6th	"	Gilded	80
1782	89	.40	4.00	"	" " 8th	"	Steel	..
1782	90, 91, 99	.35	3.50	"	" " 8th, 9th	"	"	..
2557	130, 131, 134	.40	4.00	"	" " " "	Quick	Nickel	78
274	15	.30	3.00	17	F. Pl. 1st, 2d	Slow	Gilded	60
275	17, 22, 24, 27	.50	5.00	16	3/4 Pl. 1st to 4th	Quick	"	80
275	18, 19, 23, 25, 28 to 30	.40	4.00	"	" " 1st to 5th	"	"	80
275	20, 26, 31, 35, 40, 92 to 95, 107 to 110, 127	.30	3.00	"	" " 1st, 3d, 5th to 7th, 9th	"	"	80
* 276	16, 21, 36, 41	.50	5.00	"	" " 1st, 2d, 6th, 7th	"	Nickel	80
277	17, 22, 24, 27, 36, 41	.50	5.00	"	" " 1st, to 4th, 6th, 7th	"	"	80
277	29, 32 to 34, 37 to 39, 98, 102, 125	.45	4.50	"	" " 5th to 9th, 13th, 15th	"	"	80
277	28, 31, 35, 40	.35	3.50	"	" " 3d, 5th to 7th	"	"	80
2558	41	.40	4.00	"	" " 7th	"	Steel	..
2558	98, 102, 126, 132	.35	3.50	"	" " 13th to 15th, 17th	"	"	..
275	42, 43	.30	3.00	14	" " 1st	Quick	Gilded	80
2559	128, 129	.30	3.00	"	" " 2d	"	"	78
289	44, 45	.30	3.00	12	" " 1st	"	"	80
1783	67, 71	.40	4.00	"	" " 2d, 3d	"	Steel	..
1783	68 to 70, 72 to 74	.35	3.50	"	" " " "	"	"	..
2100	87, 88, 100, 101, 111 to 114	.30	3.00	"	" " " "	Quick	Gilded	78
2177	87, 88, 100, 101, 111 to 114	.30	3.00	"	" " " "	"	"	78
2737	135	.50	5.00	"	" " 4th	"	Nickel	78
289	46 to 48	.30	3.00	10	" " 1st	"	Gilded	80
290	50, 51	.40	4.00	6	" " " "	"	"	80
290	52, 56, 75, 115	.30	3.00	"	" " 1st, 2d	"	"	80
291	49 to 51, 53 to 55	.50	5.00	"	" " " "	"	Nickel	80
291	52, 56, 75, 115	.35	3.50	"	" " " "	"	"	80
293	57 to 59	.50	5.00	0	" " 1st	"	"	78
293	60, 84	.35	3.50	"	" " " "	"	"	78
292	60, 84	.30	3.00	"	" " " "	"	Gilded	78
1784	76, 80	.40	4.00	"	" " 2d, 3d	"	Steel	..
1784	77 to 79, 81 to 83, 85, 86	.35	3.50	"	" " " "	"	"	..
2054	77, 81	.35	3.50	"	" " " "	Quick	Nickel	78
2132	85, 86, 116, 117	.30	3.00	"	" " " "	"	Gilded	78
2560	133	.40	4.00	5/0	" " 1st	"	Nickel	88
2876	133, 136	.40	4.00	"	" " 1st, 2d	"	"	72
1785	96, 97	.40	4.00	10/0	" " 1st	"	"	75

†Thick Barrel for 1720 Spring.

‡Thin Barrel for 2339 Spring.

*Stop Works are used on Barrels, Illustration No. 264, Class 1, 2 and 7; No. 267, Class 1, 7 and 65; No. 276 Class 16, 21, 36 and 41.

Observe that 18 size Hunting Movements are made both Quick Train, with 78 teeth, and Slow Train, with 60 teeth in Barrel, and in order that there may be no mistake, care should be taken to compare number of teeth in Barrel to be replaced with the number given in Catalogue.

When ordering a new Barrel, the Barrel Arbor for same should be sent, that we may properly fit Barrel to Arbor.

Note: Barrels and Arbors fitted will be supplied if desired. The price is the combined list price for Barrel and Barrel Arbor with an addition of \$1.00 per dozen or 10 cents each for fitting.

Your Jobber will supply Balance Staffs, Balance Jewels, Roller Jewels, Hands and Screws in Dozen lots in original Sealed Trade Marked Packages.























TRADE-MARKED PACKAGE



[TOP]

[BOTTOM]

BARRELS

<p>No. 264, 267</p>  <p>Htg. or O. F.</p>	<p>No. 265, 269</p>  <p>Htg. or O. F.</p>	<p>No. 266</p>  <p>Htg.</p>	<p>No. 274</p>  <p>Htg.</p>
<p>No. 275, 277</p>  <p>Htg. or O. F.</p>	<p>No. 276</p>  <p>Htg. or O. F.</p>	<p>No. 289</p>  <p>Htg.</p>	<p>No. 290, 291</p>  <p>Htg.</p>
<p>No. 292, 293</p>  <p>Htg.</p>	<p>No. 1782</p>  <p>Htg. or O. F.</p>	<p>No. 1783</p>  <p>Htg. or O. F.</p>	<p>No. 1784</p>  <p>Htg. or O. F.</p>
<p>No. 1785</p>  <p>O. F.</p>	<p>No. 2100, 2177, 2559</p>  <p>Htg. or O. F.</p>	<p>No. 2054, 2132</p>  <p>Htg. or O. F.</p>	<p>No. 2557</p>  <p>Htg. or O. F.</p>
<p>No. 2558</p>  <p>Htg. or O. F.</p>	<p>No. 2560</p>  <p>Htg.</p>	<p>No. 2737</p>  <p>O. F.</p>	<p>No. 2878</p>  <p>Htg. or O. F.</p>

BARRELS, HUBS AND SCREWS, FITTED

Catalogue No.	Class	PRICE		DESCRIPTION OF MOVEMENT			
		Piece	Per Doz.	Size	Model		
1969	89	.65	7.50	18	3/4 Pl.	8th	Steel
1969	90, 91, 99	.60	7.00	"	"	8th, 9th	"
2564	41	.65	7.50	16	"	7th	"
2564	98, 102, 126, 132	.60	7.00	"	"	14th, 15th, 17th	"
1970	67, 71	.65	7.50	12	"	2d, 3d	"
1970	68 to 70, 72 to 74	.60	7.00	"	"	"	"
1971	76, 80	.65	7.50	0	"	"	"
1971	77 to 79, 81 to 83, 85, 86	.60	7.00	"	"	"	"

No. 1969



Htg. or O. F.

No. 1970

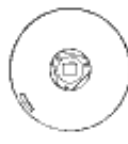

Htg. or O. F.

No. 1971



Htg. or O. F.

No. 2564

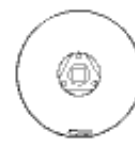

Htg. or O. F.

BUSHINGS, BARREL ARBOR

Catalogue No.	Class	PRICE		DESCRIPTION OF MOVEMENT			
		Piece	Per Doz.	Size	Model		
1887	90, 91, 99	.10	1.00	18	3/4 Pl.	8th, 9th	Nickel
2565	98, 102, 126	.10	1.00	16	"	14th, 15th, 17th	"
2344	68, 72	.10	1.00	12	"	2d, 3d	"
2103	70, 74	.10	1.00	"	"	"	Polished
2104	69, 73	.10	1.00	"	"	"	Gilded
2105	78, 79, 82, 83, 85, 86	.10	1.00	0	"	"	Polished
2106	77, 81	.10	1.00	"	"	"	Gilded

No. 1887



Htg. or O. F.

No. 2103, 2104, 2344



Htg. or O. F.

No. 2105, 2106



Htg. or O. F.

No. 2565



Htg. or O. F.

BUSHINGS, CENTER STAFF

Catalogue No.	Class	PRICE		DESCRIPTION OF MOVEMENT			
		Piece	Per Doz.	Size	Model		
2162	70, 74	.10	1.00	12	3/4 Pl.	2d, 3d	Polished

No. 2162















Htg. or O. F.

To ascertain Grade and Class of movement refer to numbers in the back of the catalogue under the head of "Number and Grade with classification and description of movements." To find where the particular kind of material required is listed, refer to the index which will be found on the last pages of this catalogue.

CAMS, SETTING

Catalogue No.	Class	Price		Description of Movement		
		Piece	Per Doz.	Size	Model	
42	1	.20	2.00	18	F. Pl.	2d to 4th
42	2 to 4	.15	1.50	"	"	"
42	119	.10	1.00	"	"	10th
46	4, 5, 118	.15	1.50	"	"	2d to 4th, 10th
174	7	.20	2.00	"	"	5th
174	8, 9	.15	1.50	"	"	"
174	10, 11, 120	.10	1.00	"	"	5th, 11th
162	12 to 14	.15	1.50	"	3/4 Pl.	6th
123	24, 25, 27, 28	.15	1.50	16	"	3d, 4th
123	26	.10	1.00	"	"	3d
1313	32, 35, 37, 41	.20	2.00	"	"	6th, 7th
1313	33, 34, 38, 39	.15	1.50	"	"	"
1313	35, 40, 92 to 95, 107 to 110	.10	1.00	"	"	"
1719	129, 129	.10	1.00	14	"	2d
1786	67, 68, 71, 72	.20	2.00	12	"	2d, 3d
1786	69, 73	.15	1.50	"	"	"
1786	70, 74	.10	1.00	"	"	"
1719	87, 88, 100, 101, 111 to 114	.10	1.00	"	"	"
2738	135	.20	2.00	"	"	4th
97	49 to 51	.15	1.50	6	"	1st
1787	76, 80	.20	2.00	0	"	2d, 3d
1787	77, 81	.15	1.50	"	"	"
1787	78, 79, 82, 83, 85, 86, 116, 117	.10	1.00	"	"	"
1788	133, 136	.15	1.50	5/0	"	1st, 2d
1788	96	.20	2.00	10/0	"	1st
1788	97	.15	1.50	"	"	"

<p>No. 42</p>  <p>Htg.</p>	<p>No. 46</p>  <p>Htg.</p>	<p>No. 97</p>  <p>Htg.</p>	<p>No. 123</p>  <p>Htg. or O. F.</p>	<p>No. 162</p>  <p>Htg. or O. F.</p>
<p>No. 174</p>  <p>O. F.</p>	<p>No. 1313</p>  <p>Htg. or O. F.</p>	<p>No. 1719</p>  <p>Htg. or O. F.</p>	<p>No. 1786</p>  <p>Htg. or O. F.</p>	<p>No. 1787</p>  <p>Htg. or O. F.</p>
<p>No. 1788</p>  <p>Htg. or O. F.</p>		<p>No. 2738</p>  <p>O. F.</p>		

Your Jobber will supply Balance Staffs, Balance Jewels, Roller Jewels, Hands and Screws in Dozen lots in original Sealed Trade Marked Packages.

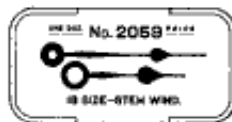

[TOP]









TRADE-MARKED PACKAGE



[BOTTOM]

CAMS, SETTING SPRING

Catalogue No.	Class	PRICE		DESCRIPTION OF MOVEMENT		
		Piece	Per Doz.	Size	Model	
1741	104, 106.....	.25	2.50	18	F. Pl.	5th
1741	63, 64.....	.20	2.00	"	"	"
2536	106.....	.25	2.50	"	"	"
1814	32, 36, 37, 41.....	.20	2.00	16	3/4 Pl.	6th, 7th
1814	33, 34, 38, 39.....	.15	1.50	"	"	"
1814	35, 40, 92 to 95, 107 to 110.....	.10	1.00	"	"	"
1789	67, 68, 71, 72.....	.20	2.00	12	"	2d, 3d
1789	69, 73.....	.15	1.50	"	"	"
1789	70, 74.....	.10	1.00	"	"	"
2739	135.....	.20	2.00	"	"	4th
1790	76, 80.....	.20	2.00	0	"	2d, 3d
1790	77, 81.....	.15	1.50	"	"	"
1790	78, 79, 82, 83, 85, 86, 116, 117.....	.10	1.00	"	"	"
2916	118, 117.....	.10	1.00	3/0	"	"
1791	133, 136.....	.20	2.00	5/0	"	1st, 2d
1791	96.....	.25	2.50	10/0	"	1st
1791	97.....	.20	2.00	"	"	"

No. 1314  Htg. or O. F.	No. 1741  O. F.	No. 1789  Htg. or O. F.	No. 1790  Htg. or O. F.	No. 1791  Htg. or O. F.
	No. 2536  O. F.	No. 2739  O. F.	No. 2916  Htg. or O. F.	



CAPS, ARBOR

Catalogue No.	Class	PRICE		DESCRIPTION OF MOVEMENT		
		Piece	Per Doz.	Size	Model	
142	24, 25.....	.20	2.00	16	3/4 Pl.	3d

No. 142  Htg.
--

CAPS, RATCHET

Catalogue No.	Class	PRICE		DESCRIPTION OF MOVEMENT		
		Piece	Per Doz.	Size	Model	
330	46.....	.30	3.00	10	3/4 Pl.	1st
331	47.....	.25	2.50	"	"	"
332	48.....	.20	2.00	"	"	"

No. 330, 331  Htg.	No. 332  Htg.
---	--

CLAMPS, MINUTE WHEEL

Catalogue No.	CLASS	PRICE		DESCRIPTION OF MOVEMENT			
		Piece	Per Doz.	Size	Model		
2632	65	.15	1.50	18	F. Pl.	7th	Nickel
2632	106, 124	.10	1.00	"	"	5th	"
2633	106	.10	1.00	"	"	"	Gilded
2945	65	.15	1.50	"	"	7th	Nickel
2945	106, 124	.10	1.00	"	"	5th	"
2958	106	.10	1.00	"	"	"	Gilded
1315	32, 33, 36 to 38, 41, 98, 126, 132	.15	1.50	16	3/4 Pl.	6th, 7th, 9th, 13th to 15th, 17th	Nickel
1315	34, 35, 39, 40, 92 to 95, 102, 107 to 110, 125, 127	.10	1.00	"	"	6th to 9th, 13th, 15th	"
1312	35, 40, 92, 94, 109, 110	.10	1.00	"	"	6th, 7th	Gilded
2566	128, 129	.10	1.00	14	"	2d	Nickel
1795	67, 68, 71, 72	.15	1.50	12	"	2d, 3d	"
1795	69, 70, 73, 74, 87, 88, 100, 101, 111 to 114	.10	1.00	"	"	"	"
2099	87, 88, 113, 114	.10	1.00	"	"	"	Gilded
2740	135	.15	1.50	"	"	4th	Nickel
2923	116, 117	.10	1.00	0	"	2d, 3d	"
2672	116, 117	.10	1.00	"	"	"	Gilded
2567	133, 136	.10	1.00	5/0	"	1st, 2d	Nickel
1798	96, 97	.10	1.00	10/0	"	1st	"

No. 1312, 1315



Htg. or O. F.

No. 1795, 2099, 2566



Htg. or O. F.

No. 1798



Htg.

No. 2567



Htg. or O. F.

No. 2632, 2633



O. F.

No. 2672, 2923



Htg. or O. F.

No. 2740



O. F.

No. 2945, 2958



O. F.

CLAMPS, RATCHET

Catalogue No.	CLASS	PRICE		DESCRIPTION OF MOVEMENT			
		Piece	Per Doz.	Size	Model		
82	12 to 14	.15	1.50	18	3/4 Pl.	6th
82	16, 21	.20	2.00	16	"	1st, 2d
82	17 to 20, 22, 23	.15	1.50	"	"	"

No. 82



Htg. or O. F.

It will be observed that in some instances more than one number is applied to the same illustration. The reason for this is that a difference exists which cannot be shown by an illustration. This difference is usually explained in the description following the catalogue number.

CLAMPS, RATCHET WHEEL

USED WITH EXPOSED WINDING WHEELS

Owing to the many different styles of finish on the ratchet wheel clamps of our exposed winding wheel models, it has become necessary to abandon the previous system of classifying them.

We now list them in three general divisions. In each of these divisions are noted the chief features of the finishes embraced by them which serves in a general way as a guide for ordering.

Catalogue No.	PRICE		DESCRIPTION OF MOVEMENT			In ordering, specify letter in addition to catalogue number.
	Piece	Per Doz.	Size	Model		
1792	.25	2.50	18	¾ Pl.	8th	A.—Circular rayed—or polished, with corners beveled and polished.
2568	"	"	16		7th, 13th, 15th	
1793	"	"	12		2d, 3d	
1793	.20	2.00	12	¾ Pl.	2d, 3d	B.—Straight rayed, with corners beveled and polished.
1794	"	"	0		"	
1792	.15	1.50	18	¾ Pl.	8th, 9th	C.—Straight rayed—or polished.
2568	"	"	16		14th, 15th, 17th	
1793	"	"	12		2d, 3d	
1794	"	"	0		"	

No. 1792



Htg. or O. F.

No. 1793



Htg. or O. F.

No. 1794



Htg. or O. F.

No. 2568



Htg. or O. F.

In ordering ratchet wheel clamps for watches having exposed winding wheels give the catalogue number and letter. To assure receiving a ratchet wheel clamp with the same finish as the original, send sample.

CLAMPS, SETTING WHEEL

Catalogue No.	CLASS	PRICE		DESCRIPTION OF MOVEMENT			
		Piece	Per Doz.	Size	Model		
1796	89 to 91, 99.....	.10	1.00	18	¾ Pl.	8th, 9th
2569	89 to 91, 99.....	.10	1.00	"		"	"
2569	134.....	.10	.75	"	"	8th
2569	130, 131.....	.10	.50	"	"	8th, 9th
335	24 to 29.....	.10	.50	16	"	3d, 4th	Gilded
124	24 to 26.....	.10	.50	"	"	3d	"
1797	76, 80.....	.10	1.00	0	"	2d, 3d
1797	77, 81.....	.10	.75	"	"	"
1797	78, 79, 82, 83, 85, 86, 116, 117.....	.10	.50	"	"	"
2570	116, 117.....	.10	.50	"	"	"
2923	116, 117.....	.10	.75	"	"	"	Nickel
2672	116, 117.....	.10	.75	"	"	"	Gilded

No. 124



Htg.

No. 335



Htg. or O. F.

No. 1796



Htg. or O. F.

No. 1797



Htg. or O. F.

No. 2569



Htg. or O. F.

No. 2570



Htg. or O. F.

No. 2672, 2923

















Htg. or O. F.

To ascertain Grade and Class of movement refer to numbers in the back of the catalogue under the head of "Number and Grade with classification and description of movements." To find where the particular kind of material required is listed, refer to the index which will be found on the last pages of this catalogue.

CLICKS

Catalogue No.	Class	Prices		Description of Movement		
		Pieces	Per Doz.	Size	Model	
13	1	.10	1.00	18	F. PL	1st
13	2 to 4	.10	.75	"	"	"
13	5	.10	.50	"	"	"
236	6, 61	.10	.50	"	"	"
1800	1	.10	1.00	"	"	2d to 4th
1800	119	.10	.75	"	"	10th
24	1	.10	1.00	"	"	2d to 4th
24	2 to 5	.10	.75	"	"	"
2356	4, 5, 9, 66	.10	.75	"	"	2d to 5th, 7th
2356	6, 10, 11, 61 & 4, 103 to 106, 118, 120, 123, 124	.10	.50	"	"	2d to 5th, 7th, 10th, 11th
1799	7, 65	.10	1.00	"	"	5th, 7th
1799	121, 122	.10	.75	"	"	7th, 11th
338	7, 65	.10	1.00	"	"	5th, 7th
338	8, 66	.10	.75	"	"	5th, 7th
81	12 to 14	.10	1.00	"	3/4 Pl.	6th
236	15	.10	.50	17	F. PL	1st
337	15	.10	.50	"	"	2d
81	16, 21	.15	1.50	16	3/4 Pl.	1st, 2d
81	17 to 20, 22, 23	.10	1.00	"	"	"
238	24, 25, 27 to 30	.10	.75	"	"	3d to 5th
337	26, 31	.10	.50	"	"	3d, 5th
347	42, 43	.10	1.00	14	"	1st
348	44, 45	.10	1.00	12	"	"
348	46 to 48	.10	1.00	10	"	"
98	49 to 51, 53 to 55	.10	.75	6	"	1st, 2d
143	52, 56, 73, 115	.10	.50	"	"	"
349	57 to 59	.10	.75	0	"	1st
350	60, 84	.10	.50	"	"	"

No. 13  Htg.	No. 24  Htg.	No. 81  Htg. or O. F.	No. 98  Htg.	No. 143  Htg.
No. 336  Htg.	No. 337  Htg. or O. F.	No. 338  Htg. or O. F.	No. 347  Htg.	No. 348  Htg.
No. 349  Htg.	No. 350  Htg.	No. 1799  O. F.	No. 1800  Htg.	No. 2356  Htg. or O. F.

Your Jobber will supply Balance Staffs, Balance Jewels, Roller Jewels, Hands and Screws in Dozen lots in original Sealed Trade Marked packages.

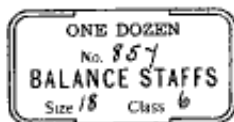

(TOP)

TRADE-MARKED PACKAGE



(BOTTOM)

CLICKS

USED WITH EXPOSED WINDING WHEELS

Owing to the many different styles of finish on the clicks of our exposed winding wheel models, it has become necessary to abandon the previous system of classifying them.

We now list them in three general divisions. In each of these divisions are noted the chief features of the finishes embraced by them which serves in a general way as a guide for ordering.

Catalogue No.	Price		Description of Movement		In ordering, specify letter in addition to catalogue number.	
	Piece	Per Doz.	Size	Model		
1801	.45	4.50	18	3/4 Pl.	8th, 9th	A.—Circular raying with cupped center polished.
1316	"	"	16	"	6th, 7th	
1802	"	"	"	"	6th to 9th, 13th to 15th, 17th	
1803	"	"	14	"	2d	
2742	"	"	12	"	2d, 3d	
1804	"	"	0	"	4th	B.—Circular raying, with cupped or flat center polished, and corner polished.
1805	"	"	10/0	"	2d, 3d	
1801	.25	2.50	18	3/4 Pl.	8th, 9th	C.—Face and corner polished.
1802	"	"	16	"	6th to 9th, 13th to 15th, 17th	
1803	"	"	14	"	2d	
1803	"	"	12	"	2d, 3d	
1805	"	"	5/0	"	1st, 2d	
1805	"	"	10/0	"	1st	D.—Straight or snailed raying, with corner polished.
1316	.15	1.50	16	3/4 Pl.	6th, 7th	
1802	"	"	"	"	6th to 9th, 13th to 15th, 17th	E.—Face polished, corner ground.
1803	"	"	14	"	2d	
1803	"	"	12	"	2d, 3d	F.—Face polished.
1804	"	"	0	"	"	
1805	"	"	5/0	"	1st, 2d	G.—Straight or snailed raying.
1805	"	"	10/0	"	1st	

No. 1316	No. 1801	No. 1802	No. 1803	No. 1804	No. 1805	No. 2742
Htg. or O. F.	Htg. or O. F.	Htg. or O. F.	Htg. or O. F.	Htg. or O. F.	Htg. or O. F.	O. F.

In ordering clicks for watches having exposed winding wheels give the catalogue number and letter. To assure receiving a click with the same finish as the original, send sample.

CLUTCHES, SETTING

Catalogue No.	CLASS	Price		Description of Movement	
		Piece	Per Doz.	Size	Model
25	1.....	.25	2.50	18	F. Pl.
25	2 to 5, 119.....	.20	2.00	"	"



It will be observed that in some instances more than one number is applied to the same illustration. The reason for this is that a difference exists which cannot be shown by an illustration. This difference is usually explained in the description following the catalogue number.

CLUTCHES, WINDING AND SETTING

Catalogue No.	CLASS	PRICE		DESCRIPTION OF MOVEMENT		
		Piece	Per Doz.	Size	Model	
1806	89 to 91, 99	.35	3.50	18	¼ Pl.	8th, 9th
1806	130, 131, 134	.30	3.00	"	"	"
1807	32 to 34, 96 to 99, 41, 98, 102, 125, 126, 132	.35	3.50	16	"	6th to 9th, 13th to 15th, 17th
1807	35, 40, 92 to 95, 107 to 110, 127	.30	3.00	"	"	6th, 7th, 9th, 13th, 15th
1808	128, 129	.30	3.00	14	"	2d
1808	67 to 69, 71 to 73	.35	3.50	12	"	2d, 3d
1808	70, 74, 87, 88, 100, 101, 111 to 114	.30	3.00	"	"	"
2741	135	.35	3.50	"	"	4th
1809	76, 77, 80, 81	.35	3.50	0	"	2d, 3d
1809	78, 79, 82, 83, 85, 86, 116, 117	.30	3.00	"	"	"
1810	133, 136	.30	3.00	5/0	"	1st, 2d
1810	96	.35	3.50	10/0	"	1st
1810	97	.30	3.00	"	"	"

No. 1806	No. 1807	No. 1808	No. 1809	No. 1810	No. 2741
Htg. or O. F.	Htg. or O. F.	Htg. or O. F.	Htg. or O. F.	Htg. or O. F.	O. F.

COLLETS, HAIR SPRING

Catalogue No.	CLASS	PRICE		DESCRIPTION OF MOVEMENT		
		Piece	Per Doz.	Size	Model	
352	1 to 11, 61 to 66, 103 to 106, 118, 120	.10	.50	18	F. Pl.	1st to 5th, 7th, 10th, 11th
	122 to 124	.10	.50	"	"	1st to 5th
353	1 to 11, 61	.10	.50	"	"	2d to 4th, 7th, 10th, 11th
*1318	1, 65, 119, 121	.10	.50	"	¼ Pl.	6th
358	12 to 14	.10	.50	"	"	8th, 9th
1811	89 to 91, 99	.10	.50	"	"	"
1318	130, 131, 134	.10	.50	"	"	"
354	15	.10	.50	17	F. Pl.	1st, 2d
1318	16, 17, 21, 22, 24, 29, 32 to 41	.10	.50	16	¼ Pl.	1st to 3d, 5th to 7th
1318	92 to 95, 98, 102, 107 to 110, 125 to 127, 132	.10	.50	"	"	6th to 9th, 13th to 15th, 17th
358	17 to 20, 22 to 28, 30, 31	.10	.50	"	"	1st to 5th
358	42, 43	.10	.50	14	"	1st
2572	128, 129	.10	.50	"	"	2d
357	44, 45	.10	.50	12	"	1st
2572	67 to 74, 87, 88, 100, 101, 111 to 114	.10	.50	"	"	2d, 3d
2743	135	.10	.50	"	"	4th
357	46 to 48	.10	.50	10	"	1st
1318	49, 53 to 56, 75, 115	.10	.50	6	"	1st, 2d
358	50 to 52, 54 to 56	.10	.50	"	"	"
359	57 to 60, 76 to 86, 116, 117	.10	.50	0	"	1st to 3d
1330	58 to 60	.10	.50	"	"	1st
2744	133, 136	.10	.50	5/0	"	1st, 2d
2139	96, 97	.10	.50	10/0	"	1st

No. 352, 353, 354	No. 357, 358, 1318 2572, 2743	No. 359, 1330	No. 1811	No. 2139, 2744
Htg. or O. F.	Htg. or O. F.	Htg. or O. F.	Htg. or O. F.	Htg. or O. F.

*Used with Double Roller Staffs.

To ascertain Grade and Class of movement refer to numbers in the back of the catalogue under the head of "Number and Grade with Classification and Description of Movements." To find where the particular kind of material required is listed, refer to the index which will be found on the last pages of this catalogue.

COLLETS, BARREL ARBOR

Catalogue No.	CLASS	PRICE		DESCRIPTION OF MOVEMENT	
		Piece	Per Doz.	Size	Model
351	7, 65.....	.10	1.00	18	F. Pl. 5th, 7th

No. 351



O. F.

CUPS, ARBOR

Catalogue No.	CLASS	PRICE		DESCRIPTION OF MOVEMENT	
		Piece	Per Doz.	Size	Model
360	1 to 6.....	.10	1.00	18	F. Pl. 1st
361	5, 6.....	.10	1.00	"	"
362	5.....	.15	1.50	"	"
363	42, 43.....	.10	1.00	14	3/4 Pl. "
363	44, 45.....	.10	1.00	12	"

.....
Large Gilt Base
Large Steel Base
.....

No. 360



Htg.

No. 361, 362



Htg.

No. 363



Htg.

CUPS, CENTER

Catalogue No.	CLASS	PRICE		DESCRIPTION OF MOVEMENT	
		Piece	Per Doz.	Size	Model
364	42.....	.10	1.00	14	3/4 Pl. 1st
365	44.....	.10	1.00	12	"
365	46, 47.....	.10	1.00	10	"

No. 364, 365



Htg.

Read carefully the introduction which explains fully our system of cataloguing.

It will be observed that in some instances more than one number is applied to the same illustration. The reason for this is that a difference exists which cannot be shown by an illustration. This difference is usually explained in the description following the catalogue number.

Orders for less than one-fourth dozen will be charged at single piece price.

PRICES OF DIALS

ENAMEL, REGULAR

	PRICE	
	Piece	Per doz.
Double Sunk Glass Enamel " " " " (Continuous Minute Figures)	\$2.00	\$24.00
Single " " " " (Continuous Minute Figures)	2.25	27.00
" " " " (Continuous Minute Figures)	1.00	12.00
Skylight or O. F. Glass Enamel	1.25	15.00
Winding Indicator	1.00	12.00
Single Sunk Hard Enamel Depressed Center	1.50	18.00
" " " " excepting 14 size, 2d and 12 size, 4th Models	.75	9.00
" " " " 14 2nd and 12 4th	1.50	18.00
" " " " (Continuous Minute Figures)	1.00	12.00
Skylight or O. F. Hard Enamel	.75	9.00
Curved Surface, Single Sunk or Full Open Face Hard Enamel, 12 x 0	1.50	18.00

ENAMEL, FANCY

Double Sunk	2.50	30.00
" " Gold Numerals	3.00	36.00
Single " " Gold Numerals	1.00	12.00
" " " " Gold Numerals	1.50	18.00
Skylight or O. F. " " Gold Numerals	1.00	12.00
" " " " Gold Numerals	1.50	18.00
Solid Color Depressed Second Gold Numerals	2.50	30.00
" " " " Skyliht or O. F. " "	1.50	18.00

METAL, GOLD PLATED OR SILVER PLATED

Sunk Second, Skyliht or O. F.	2.00	24.00
" " (Continuous Minute Figures)	2.50	30.00
Winding Indicator	2.50	30.00
Curved Surface	3.00	36.00

Enamel dials, regular quality, will be supplied with letters of a name in place of regular figures at \$2.00 each in advance of the list price.

NOTES

Under illustrations of dials commencing with page 38 the various sizes are given in which that particular style is furnished. Illustrations are intended to give an idea of the general style of hours only and not the size.

When ordering dials in addition to the catalogue number it is necessary to give the size, quality, style and model. As an illustration "No. D29, 18 size glass enamel double sunk 8th and 9th model."

Double sunk dials are made only in enamel and furnished only for 18 and 16 size movements.

Dials for 16 Size, Classes 16, 21, 27 and 28, are fitted in a Dial Ring, and are not furnished separate from the ring; an extra charge is made of \$6.00 per dozen for this style. Classes 27 and 28 have no Second Bits, being for Sweep Second Movements.

In order to assist in determining the models of Movements for which Dials are required, commencing on page 43, is shown the exact location the dial feet bear as relates the twelfth hour in all our various sizes and models.

ILLUSTRATIONS OF DIALS

No. D1



18, 16, 12, 6 and 0 Sizes

No. D6

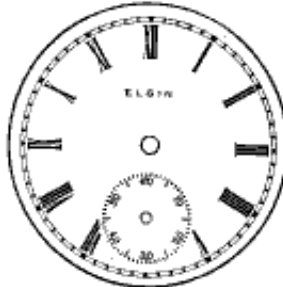

18, 16, 12, 6 and 0 Sizes

No. D19

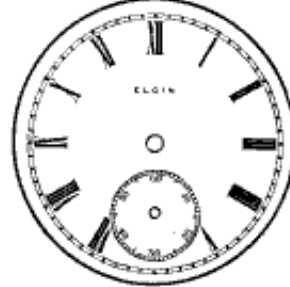

18, 16, 12, 6 and 0 Sizes

No. D87

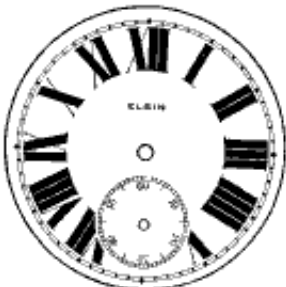

18, 16, 12, 6 and 0 Sizes

No. D111

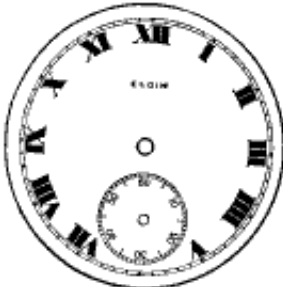
16, 12, 0, 0 Sky, 3/0, 3/0 Sky,
5/0, 5/0 Sky and 10/0 Sizes

No. D147

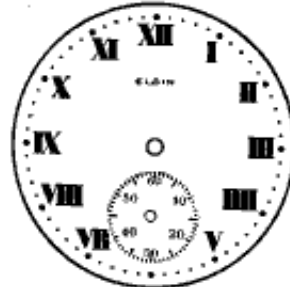

16, 12 and 0 Sizes

No. D7



18, 16, 12 and 6 Sizes

No. D20



18, 16, 12, 6 and 0 Sizes

No. D5



18, 16, 12, 6 and 0 Sizes

No. D10

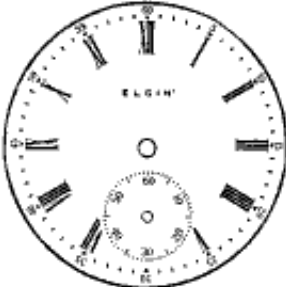

18, 16, 12, 6, 0 and 3/0 Sizes

No. D17



18, 16 and 12 Sizes

No. D22

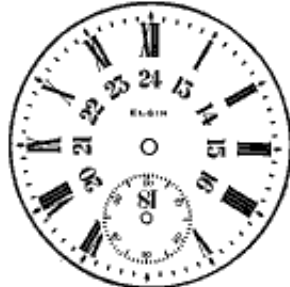

18, 16 and 12 Sizes

ILLUSTRATIONS OF DIALS—Continued

No. D27



18, 16, 12, 6 and 0 Sizes

No. D33



18, 16, 12, 6 and 0 Sizes

No. D35



18, 16, 12, 6 and 0 Sizes

No. D29

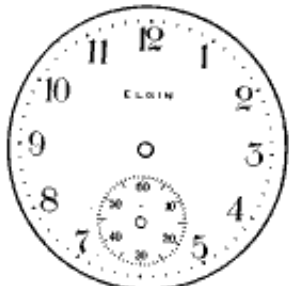

18, 16, 12, 6, 0, 5/0 and 10/0 Sizes

No. D44



18, 16, 12 and 6 Sizes

No. D49



18, 16 and 12 Sizes

No. D45



18, 16, 12, 6 and 0 Sizes

No. D131



6, 0, 3/0 and 5/0 Sizes

No. D28



18, 16, 12, 6 and 0 Sizes

No. D34



18, 16, 12, 6 and 0 Sizes

No. D32



18, 16, 12, 6 and 0 Sizes

No. D38

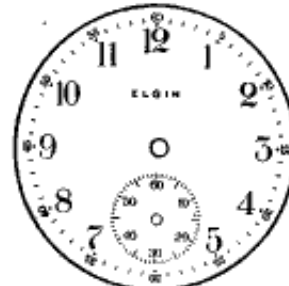

18, 16, 12, 6 and 0 Sizes

ILLUSTRATIONS OF DIALS—Continued

No. D54



18, 16, 12 and 0 Sizes

No. D119



16, 12, 6, 0, 5/0 and 10/0 Sizes

No. D47



18, 16, 12 and 0 Sizes

No. D78



18, 16, 12, 6, 0, 3/0 and 10/0 Sizes

No. D89



18, 16, 14, 12, 6, 0 and 3/0 Sizes

D52



18, 16, 12, 0, 3/0 and 10/0 Sizes

No. D96

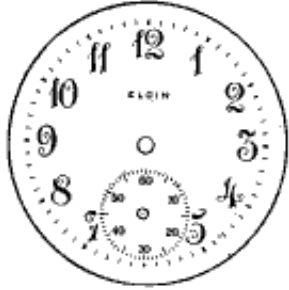

16, 12 and 0 Sizes

No. D92



18, 16, 12, 6 and 0 Sizes

No. D133



16, 12, 0, 3/0, 5/0 and 10/0 Sizes

No. D101



18, 16, 12, 6 and 0 Sizes

No. D115



18 and 16 Sizes

No. D23



18, 16 and 12 Sizes

ILLUSTRATIONS OF METAL DIALS

No. D113



16, 12, 6, 0, 0 Sky, 3/0 Sky, 5/0, 5/0 Sky, 10/0 and 10/0 Sky Sizes

No. D117



Winding Indicator — 18 and 16 Sizes

No. D125



18, 16, 12, 6, 0, 5/0 and 10/0 Sizes

No. D114



16, 12, 6, 0, 0 Sky, 3/0 Sky, 5/0, 5/0 Sky, 10/0 and 10/0 Sky Sizes

No. D155



Continuous Minute Figures
18 and 16 Sizes

No. D16



16, 12 and 0 Sizes

No. D14

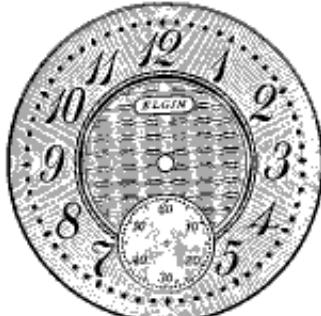

Basket Center
16, 12 and 0 Sizes

No. D51



18 and 16 Sizes

No. D134



12, 3/0, 5/0, 5/0 Sky, 10/0 and 10/0 Sky Sizes

No. D121



0, 3/0, 5/0 and 10/0 Sizes

Metal dials are made gold plated and silver plated. When ordering specify which is wanted. Continuous minute figure dial illustration No. D155 will be supplied plain or with center circle as in illustration. When ordering specify plain or center circle.

FANCY DIALS



Fancy Arabic

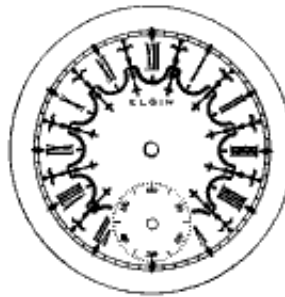

Fancy Roman

These dials are decorated in various tints with gold and silver ornaments and can be supplied for most of our sizes and models.

OPEN FACE AND SKYLIGHT DIALS

O Size



Full Open Face

O Size Skylight

 $\frac{3}{4}$ Opening

O Size Skylight

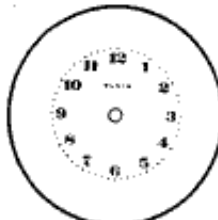

Regular Opening

5/0 Size



Full Open Face

5/0 Size Skylight

 $\frac{3}{4}$ Opening

5/0 Size Skylight

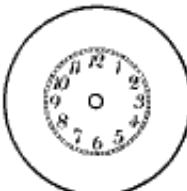

Regular Opening

10/0 Size



Full Open Face

10/0 Size Skylight

 $\frac{3}{4}$ Opening

10/0 Size Skylight

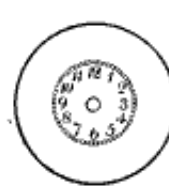

Regular Opening

When ordering open face dials without second bits specify "Full Open Face."

When ordering skylight dials specify whether they are to be used in cases having regular opening or $\frac{3}{4}$ opening.

Always state size and model of watch for which dial is wanted, and if there is any doubt give the number of movement.

When ordering dials for wrist watches specify, in addition to model and number of movement, whether they are to be used in regular bracelet or convertible cases.

3/0 SIZE DIALS

3/0 size dials are 1.03 inches in diameter.

When made skylight "Regular Opening" the opening is the same as on O size skylight "Regular Opening."

When made skylight " $\frac{3}{4}$ opening" the painting is the same as on 5/0s "Full Open Face."

LOCATION OF DIAL FEET

On account of the feet on Dials of the several Models being located in different positions, it has been thought advisable to illustrate the place they occupy as relates the twelfth hour in the various sizes and styles.

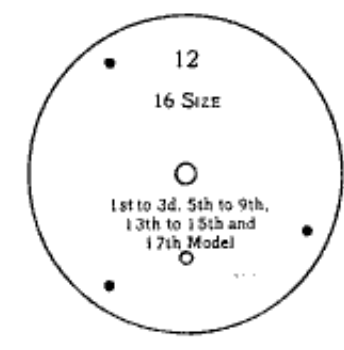
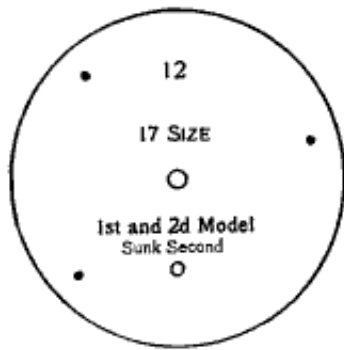
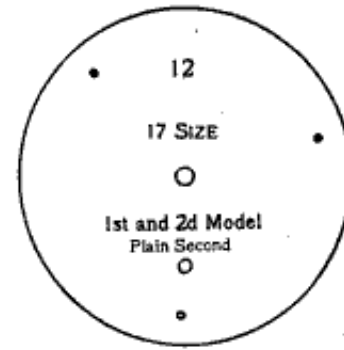
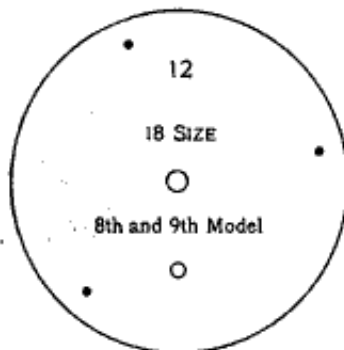
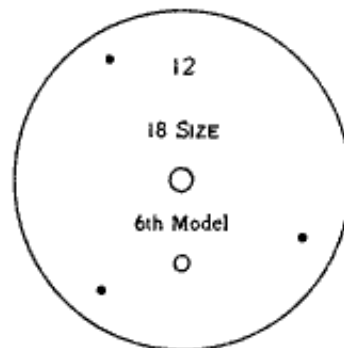
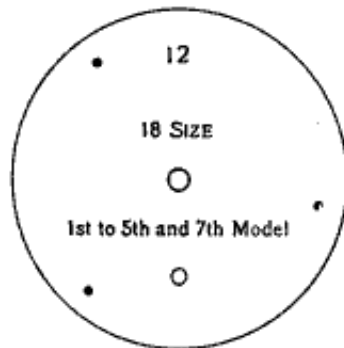

LOCATION OF DIAL FEET—Continued

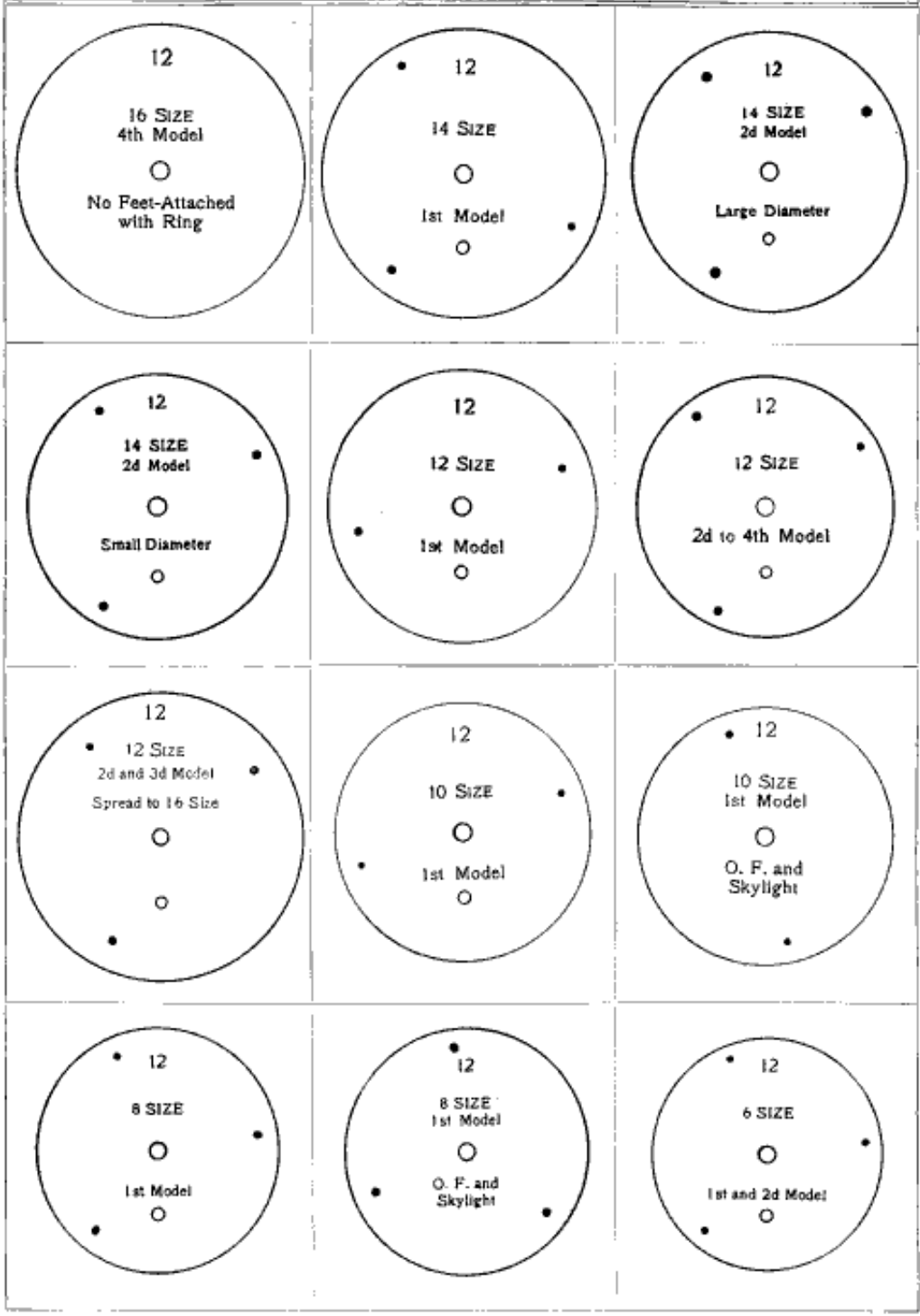

LOCATION OF DIAL FEET—Continued

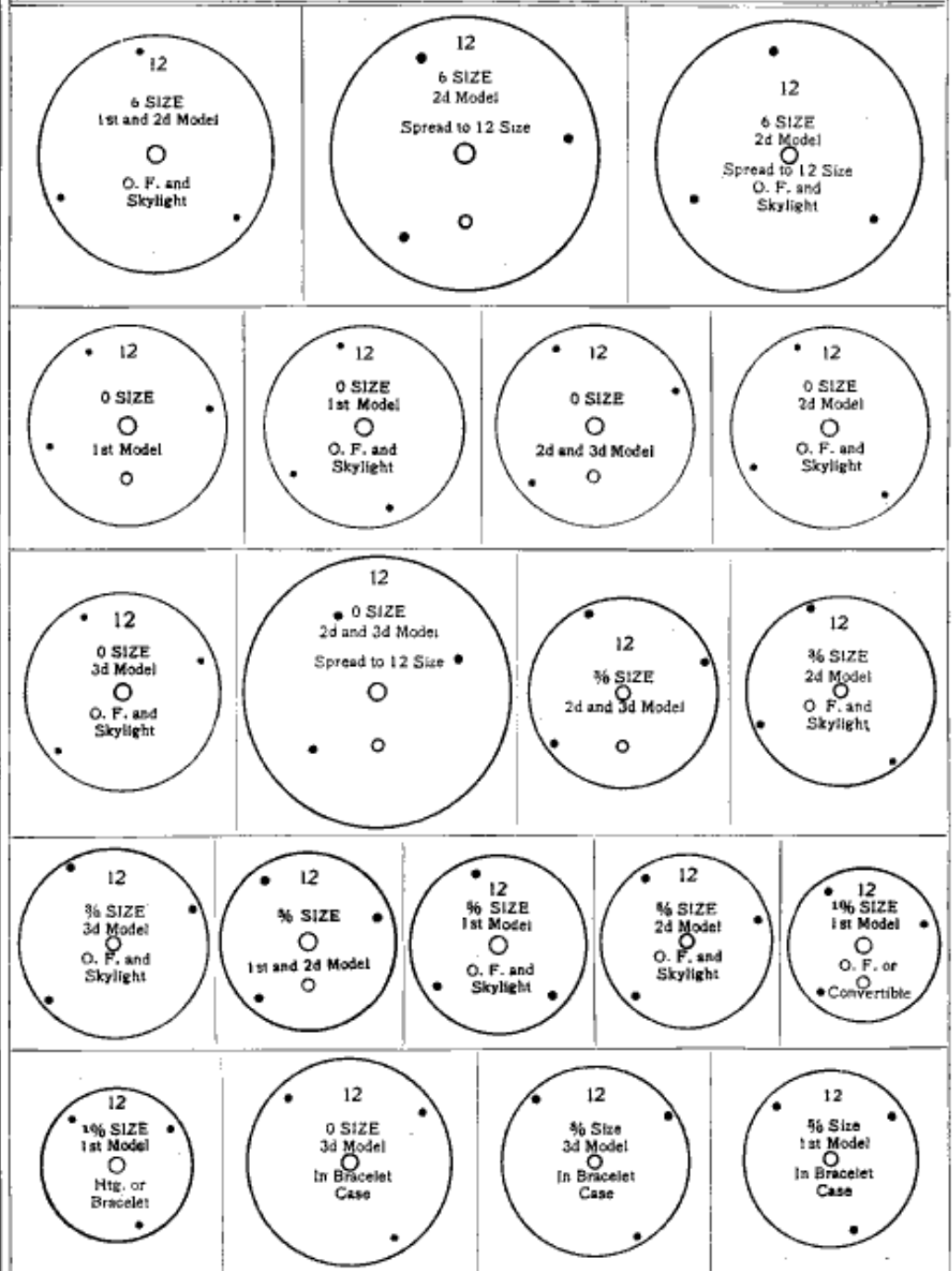

When ordering dials for wrist watches specify, in addition to model and number of movement, whether they are to be used in regular or convertible cases.

FORKS

Catalogue No.	CLASS	PRICE		DESCRIPTION OF MOVEMENT			
		Piece	Per Doz.	Size	Model		
1	1, 2, 7, 65	25	2.50	18	F. Pl.	1st to 5th, 7th	Straight Line
1	3, 4, 8, 9, 66, 118, 120, 123, 124	20	2.00	"	"	1st to 5th, 7th, 10th, 11th	
1	5, 10, 11, 61, 63, 64, 104, 106, 122	15	1.50	"	"	1st to 5th, 7th	Right Angle
3	3 to 5	15	1.50	"	"	1st to 4th	
3	6, 61, 62, 103, 105	10	1.00	"	"	"	
1814	1, 65	70	8.00	"	"	2d to 4th, 7th	Straight Line
2574	124	55	6.50	"	"	7th	
2574	106	50	6.00	"	"	5th	" " "
2511	119, 121	50	6.00	"	"	10th, 11th	
1	12	20	2.00	"	3/4 Pl.	6th	" " "
1814	89	75	9.00	"	"	8th	
1814	90, 91, 99	70	8.00	"	"	8th, 9th	" " "
2074	90, 91, 99	50	6.00	"	"	"	
2574	130, 131, 134	55	6.50	"	"	"	" " "
1814	36, 41, 132	75	9.00	16	"	6th, 7th, 15th	
1814	98, 126	70	8.00	"	"	9th, 13th to 15th, 17th	" " "
1814	102, 125	60	7.00	"	"	8th, 9th, 15th	
2574	33, 38, 98, 107, 108	55	6.50	"	"	6th, 7th, 15th	" " "
2074	36, 41	50	6.00	"	"	6th, 7th	
1	16, 21, 36, 41	50	6.00	"	"	1st, 2d, 6th, 7th	" " "
1	17, 18, 22, 32, 37, 98	25	2.50	"	"	1st, 2d, 6th, 7th, 9th	
1	19, 23 to 25, 27 to 30, 33, 34, 38, 39, 102, 107, 108	20	2.00	"	"	1st to 7th, 9th	" " "

No. 1



Htg. or O. F.

No. 3



Htg.

No. 1814, 2574



Htg. or O. F.

No. 2074



Htg. or O. F.

No. 2511



Htg. or O. F.

HUBS, BARREL

Catalogue No.	CLASS	PRICE		DESCRIPTION OF MOVEMENT		
		Piece	Per Doz.	Size	Model	
1820	89 to 91, 99	.30	3.00	18	3/4 Pl.	8th, 9th
2575	41, 98, 102, 126, 132	.30	3.00	16	"	7th, 13th to 15th, 17th
1821	67 to 74	.30	3.00	12	"	2d, 3d
1822	76 to 83, 85, 86	.30	3.00	0	"	"

No. 1820



Htg. or O. F.

No. 1821



Htg. or O. F.

No. 1822



Htg. or O. F.

No. 2575



Htg. or O. F.

HUBS, BARREL ARBOR

Catalogue No.	CLASS	PRICE		DESCRIPTION OF MOVEMENT		
		Piece	Per Doz.	Size	Model	
1816	89 to 91, 99	.15	1.50	18	3/4 Pl.	6th, 9th
2576	41, 98, 102, 126, 132	.15	1.50	16	"	7th, 13th to 15th, 17th
1817	67 to 74	.15	1.50	12	"	2d, 3d
2745	135	.15	1.50	"	"	4th
1818	76 to 82, 83, 85, 86	.15	1.50	0	"	2d, 3d
1819	133, 136	.15	1.50	5/0	"	1st, 2d
1819	96, 97	.15	1.50	10/0	"	1st

No. 1816



Htg. or O. F.

No. 1817



Htg. or O. F.

No. 1818



Htg. or O. F.

No. 1819



Htg. or O. F.

No. 2576



Htg. or O. F.

No. 2745



O. F.

HANDS, HOUR AND MINUTE

Cata- logue No.	DESCRIPTION OF MOVEMENT		A ¹ Doz. Pair	A Doz. Pair	B Doz. Pair	C Doz. Pair	DESCRIPTION OF HANDS
	Size	Model					
2410	18	1st70	.50	.25	Spade Hour, Whip Minute
2308	"	"70	.50	.25	Spade Hour, Whip Minute
2411	"	"70	.50	.25	Spade Hour, Whip Minute
19	"	"	Spade Hour and Minute
20	"	"70	.50	.25	Spade Hour and Minute
22	"	"80	.60	...	Fleur de Lis
2065	"	"80	.60	...	Moon
23	"	"80	.60	...	Morning Glory
2603	"	2d to 9th50	.35	Spade Hour, Whip Minute
2060	"	"70	.50	.35	Spade Hour, Whip Minute
2061	"	"70	.50	.25	Spade Hour, Whip Minute
2412	"	"70	.50	.25	Spade Hour, Whip Minute
2059	"	"70	.50	.35	Spade Hour and Minute
1319	"	"70	.50	.35	Spade Hour and Minute
394	"	"25	Spade Hour and Minute
393	"	"70	.50	.25	Spade Hour and Minute
391	"	"80	.60	...	Fleur de Lis
392	"	"80	.60	...	Morning Glory
1320	"	"80	.60	...	Moon
*1324	"	"	Louis XIV, Blue, Gold or Gold Plated
19	17	1st25	Spade Hour and Minute
394	"	"25	Spade Hour and Minute
2604	16	3d, 5th to 9th, 13th to 15th, 17th50	.35	Spade Hour, Whip Minute
2889	"	1st, 2d50	.35	Spade Hour, Whip Minute
2062	"	3d, 5th to 9th, 13th to 15th, 17th70	.50	.25	Spade Hour, Whip Minute
2413	"	1st, 2d70	.50	.25	Spade Hour, Whip Minute
2533	"	3d, 5th to 9th, 13th to 15th, 17th70	.50	.35	Spade Hour and Minute
2329	"	"70	.50	.25	Spade Hour, Whip Minute
2063	"	"70	.50	.25	Spade Hour, Whip Minute
2538	"	"70	.50	.25	Spade Hour, Straight Minute
395	"	1st, 2d70	.50	.25	Spade Hour and Minute
397	"	3d, 5th to 9th, 13th to 15th, 17th70	.50	.25	Spade Hour and Minute
2332	"	"70	.50	...	Spade Double Hour, Whip Minute
2925	"	"80	.60	...	Fleur de Lis
2146	"	"80	.60	...	Imperial Moon
21	"	1st, 2d	4.00	.80	.60	...	Moon
396	"	3d, 5th to 9th, 13th to 15th, 17th	4.00	.80	.60	...	Moon
398	"	4th	Moon
*2414	"	1st, 2d	Louis XIV, Blue, Gold or Gold Plated
*1325	"	3d, 5th to 9th, 13th to 15th, 17th	Louis XIV, Blue, Gold or Gold Plated
2987	14	2d70	.50	.25	Spade Hour, Whip Minute
2540	"	"70	.50	.25	Spade Hour, Whip Minute
400	"	1st70	.50	.25	Spade Hour and Minute
399	"	"	4.00	.80	.60	...	Moon
2788	"	2d80	.60	...	Imperial Moon
403	12	1st70	.50	.25	Spade Hour and Minute
402	"	"60	...	Morning Glory
401	"	"60	...	Fleur de Lis
2893	"	2d, 3d50	.35	Spade Hour, Whip Minute
2064	"	"	4.00	.70	.50	.25	Spade Hour, Whip Minute
2415	"	"70	.50	...	Spade Hour, Whip Minute
2333	"	"70	.50	...	Spade Double Hour, Whip Minute
2107	"	"70	.50	.25	Spade Hour and Minute
2789	"	4th80	.60	...	Imperial Moon
*1812	"	2d, 3d	Louis XIV, Blue, Gold or Gold Plated
2922	"	"60	...	Morning Glory
2987	12x16	"70	.50	.25	Spade Hour, Whip Minute
403	10	1st70	.50	.25	Spade Hour and Minute
402	"	"60	...	Morning Glory
401	"	"60	...	Fleur de Lis
2962	6	1st, 2d50	.35	Spade Hour, Whip Minute
405	"	"70	.50	.25	Spade Hour and Minute
404	"	"	4.00	.80	.60	...	Moon
*1326	"	"	Louis XIV, Blue Gold or Gold Plated
*1327	"	"	Louis XIV, Blue, Gold or Gold Plated
†1321	"	"	4.00	.80	.60	...	Moon
2893	6x12	2d70	.50	.35	Spade Hour, Whip Minute
2107	"	"70	.50	.25	Spade Hour and Minute
2768	0	1st to 3d50	.35	Spade Hour, Whip Minute
2307	"	"	4.00	.70	.50	.25	Spade Hour, Whip Minute
2334	"	"70	.50	...	Spade Double Hour, Whip Minute
407	"	"70	.50	.25	Spade Hour and Minute
2988	"	"80	.60	...	Moon
406	"	"	4.00	.80	.60	...	Moon
2924	"	"60	...	Fleur de Lis
*1328	"	"	Louis XIV, Blue, Gold or Gold Plated
†1322	"	"80	.60	...	Moon
†1323	"	"80	.60	...	Gothic
†1329	"	"	Louis XIV, Blue, Gold or Gold Plated
2765	0x12	2d, 3d70	.50	.25	Spade Hour, Whip Minute
2980	3/0	"70	.50	.25	Spade Hour, Whip Minute
2992	"	"50	.35	Spade Hour, Whip Minute
2991	5/0	1st, 2d50	.35	Spade Hour, Whip Minute
2571	"	"70	.50	.25	Spade Hour, Whip Minute
2918	"	"60	...	Moon

HANDS, HOUR AND MINUTE—Continued

Catalogue No.	DESCRIPTION OF MOVEMENT		A1	A	B	C	DESCRIPTION OF HANDS
	Size	Model					
*2766	5/0	1st, 2d	Louis XIV, Blue, Gold or Gold Plated Moon
†2919	"	"60	...	Spade Hour and Minute
†2920	"	"50	...	Spade Hour, Whip Minute
2147	10/0	1st70	.50	.25	Imperial Moon
2940	"	"60	...	Louis XIV, Blue, Gold or Gold Plated Moon
*2149	"	"60	...	Spade Hour and Minute
†2892	"	"50	...	
†2921	"	"50	...	

*Louis XIV Hour and Minute Hands.

†For Skylight Dials.

FINISH OF HANDS

- A1 Straw Color Extra Fine.
 A Straw Color Fine.
 B Blue Color Fine.
 C Blue Good Quality.

GOLD PLATED HOUR AND MINUTE HANDS

Only B Quality hands will be supplied gold plated. A charge of 20 cents a dozen pairs additional will be made for gold plating.

Any style of hands in B quality will be supplied gold plated if so ordered.

*LOUIS XIV HOUR AND MINUTE HANDS

Solid Gold 14K.....	Per doz. pairs	\$6.00
Composition Gold Plated.....	" " "	.75
Composition Blue.....	" " "	1.00

In ordering specify the catalogue number of hands, also quality.

The various numbers of hands are made only in the qualities under which they are listed.



In ordering hands always state catalogue number and quality wanted.

One-half of the dozen price will be charged for either hour or minute hands when ordered separately.



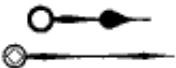
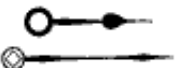

Not less than 1 dozen pairs of C quality or ½ dozen pairs of A or B composition or steel gold plated hands will be supplied at the dozen price.

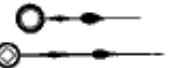
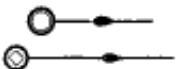
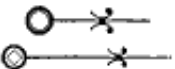
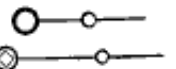
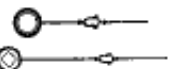
HANDS, HOUR AND MINUTE

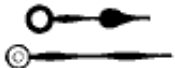
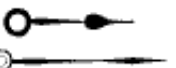
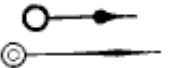
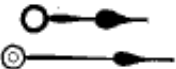

18 AND 17 SIZE, KEY WIND

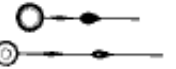
<p>No. 2410</p> 	<p>No. 2398</p> 	<p>No. 2411</p> 	<p>No. 19</p> 
<p>No. 20</p> 	<p>No. 22</p> 	<p>No. 2065</p> 	<p>No. 23</p> 

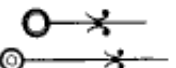
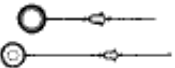
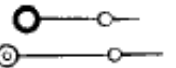
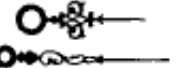
18 SIZE, STEM WIND

<p>No. 2603</p> 	<p>No. 2060</p> 	<p>No. 2061</p> 	<p>No. 2412</p> 
<p>No. 2059</p> 	<p>No. 1319</p> 	<p>No. 394</p> 	<p>No. 393</p> 
<p>No. 391</p> 	<p>No. 392</p> 	<p>No. 1320</p> 	<p>No. 1324</p> 

16 SIZE

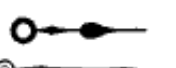
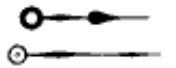
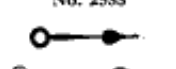
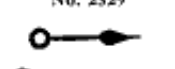
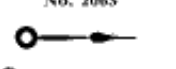
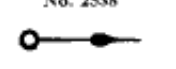
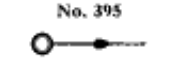
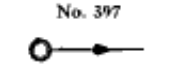
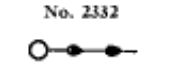
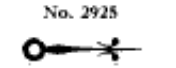
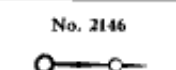
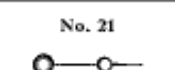
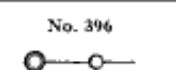
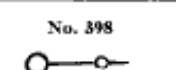
<p>No. 2604</p> 	<p>No. 2889</p>  <p>For 1st and 2d Model</p>	<p>No. 2062</p> 	<p>No. 2413</p>  <p>For 1st and 2d Model</p>
<p>No. 2533</p> 	<p>No. 2329</p> 	<p>No. 2063</p> 	<p>No. 2538</p> 
<p>No. 395</p>  <p>For 1st and 2d Model</p>	<p>No. 397</p> 	<p>No. 2332</p> 	<p>No. 2925</p> 
<p>No. 2146</p> 	<p>No. 21</p>  <p>For 1st and 2d Model</p>	<p>No. 396</p> 	<p>No. 398</p>  <p>For 4th Model</p>

HANDS, HOUR AND MINUTE—Continued

16 SIZE, FANCY

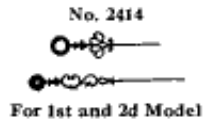

14 SIZE

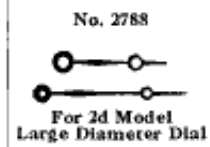
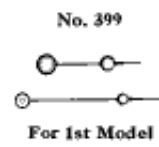
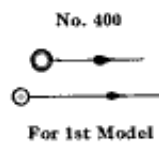
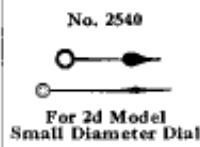
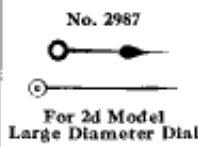

12 AND 10 SIZE, KEY WIND

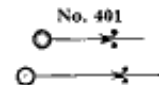
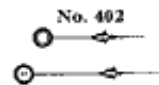
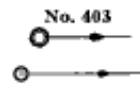

12 SIZE, STEM WIND

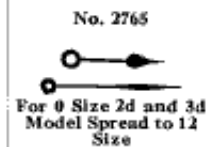
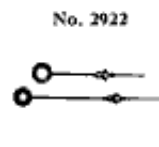
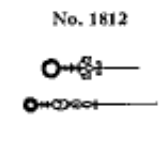
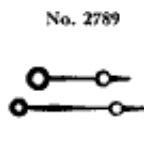
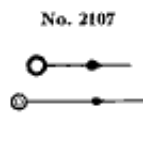
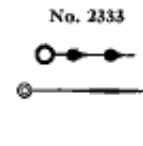
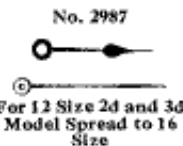
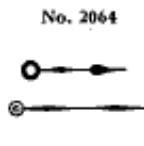
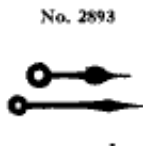

6 SIZE

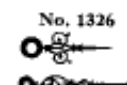
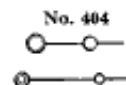
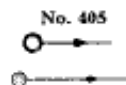
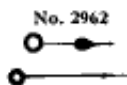





18 AND 16 SIZE, WINDING INDICATOR HAND

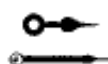
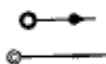
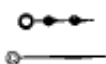
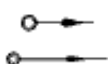
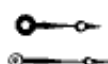
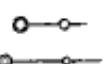
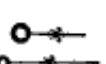
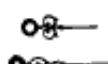

HANDS, HOUR AND MINUTE—Continued



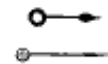
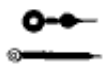
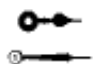
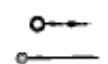
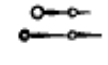
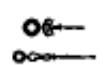
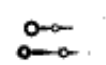
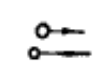

O SIZE

<p>No. 2768</p> 	<p>No. 2307</p> 	<p>No. 2334</p> 	<p>No. 407</p> 	
<p>No. 2988</p> 	<p>No. 406</p> 	<p>No. 2924</p> 	<p>No. 1328</p> 	
	<p>No. 1322</p>  <p>For Skylight</p>	<p>No. 1323</p>  <p>For Skylight</p>	<p>No. 1329</p>  <p>For Skylight</p>	

3/0 AND 5/0 SIZE

<p>No. 2980</p>  <p>For 3/0 Size</p>	<p>No. 2992</p>  <p>For 3/0 Size</p>	<p>No. 2991</p>  <p>For 5/0 Size</p>	<p>No. 2571</p>  <p>For 5/0 Size</p>
<p>No. 2918</p>  <p>For 5/0 Size</p>	<p>No. 2766</p>  <p>For 5/0 Size</p>	<p>No. 2919</p>  <p>For 5/0 Size Skylight</p>	<p>No. 2920</p>  <p>For 5/0 Size Skylight</p>

10/0 SIZE

<p>No. 2147</p> 	<p>No. 2940</p> 	<p>No. 2149</p> 	<p>No. 2892</p>  <p>For Skylight</p>	<p>No. 2921</p>  <p>For Skylight</p>
---	---	---	--	---

DOUBLE HOUR HANDS

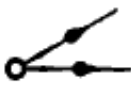
	<p>No. 2941</p>  <p>For 18 Size</p>	<p>No. 2942</p>  <p>For 16 Size</p>	
--	--	--	--





















Double hour hands are made in combinations of either Blue and Red or Blue and Gold plated. When ordering please specify which combination is desired also which color is to be in advance.

Double hour hands are \$3.00 per dozen or 30 cents each.

Winding Indicator hands are 25 cents per dozen.

HANDS, SECOND

Catalogue No.	DESCRIPTION OF MOVEMENT		A'	A	B	C	Solid Gold	Composition	Gold Plated
	Size	Model	Doz.	Doz.	Doz.	Doz.	Doz.	Doz.	Doz.
408	18	1st to 9th30	.20	.1530
2066	"	"30	.20	.1530
2605	"	2d to 9th30	.20	.1530
2416	"	1st to 9th	2.00	.50
408	17	1st, 2d15
413	16	1st to 3d, 5th to 9th, 13th to 15th, 17th30	.20	.1530
423	"	4th	6.00
2539	"	1st to 3d, 5th to 9th, 13th to 15th, 17th30	.20	.1530
2606	"	"20	.1530
2417	"	"	2.00	.50
413	14	1st30	.20	.1530
2541	"	2d30	.20	.1530
2108	12	1st to 3d30	.20	.1530
2998	"	4th30	.20	.1530
2418	"	1st to 3d	2.00	.50
413	10	1st30	.20	.1530
429	0	1st, 2d30	.20	.1530
2419	"	"2030
1838	0	1st to 3d30	.20	.1530
2769	"	"2030
2420	"	"	2.00	.50
2981	3/0	2d, 3d30	.20	.1530
2148	5/0	1st, 2d30	.20	.1530
2421	"	"	2.00	.50
2148	10/0	1st30	.20	.1530
2421	"	"	2.00	.50

No. 408  For 18 and 17 Size	No. 2066  For 18 Size	No. 2605, 2606  For 18 and 16 Size	No. 2416  For 18 Size	No. 413  For 16, 14 and 10 Size	No. 423  For 16 Size	
No. 2539  For 16 Size	No. 2417  For 16 Size	No. 2541  For 14 Size	No. 2108  For 12 Size	No. 2998  For 12 Size	No. 2418  For 12 Size	No. 429  For 6 Size
No. 2419  For 6 Size	No. 1838  For 0 Size	No. 2769  For 0 Size	No. 2420  For 0 Size	No. 2981  For 3/0 Size	No. 2148  For 5/0 and 10/0 Size	No. 2421  For 5/0 and 10/0 Size

ASSORTED HANDS

Assortment No. 2997.....Price \$2.50













18 Dozen Medium Spade Hour and Minute Hands and Dart End Second Hands.



This assortment is carefully proportioned. It is made up with a larger quantity of minutes than hours and the sizes most commonly used are supplied in largest quantities. For other Hand Assortments see page 132.

INDEXES

Catalogue No.	CLASS	PRICE		DESCRIPTION OF MOVEMENT			
		Piece	Per Doz.	Size	Model		
432	1, 7, 65.....	.35	3.50	18	F. Pl.	1st to 5th, 7th	Steel
432	3, 8, 66, 105, 106, 122 to 124.....	.30	3.00	"	"	"	"
433	4, 5, 9, 10, 62, 64, 103, 104.....	.20	2.00	"	"	1st to 5th	Gilded
435	5, 10, 61, 63, 105, 106.....	.15	1.50	"	"	"	"
1563	1 to 6, 11, 61, 63, 105, 106.....	.15	1.50	"	"	"	Nickel
1544	4, 5, 9, 10, 66.....	.20	2.00	"	"	2d to 5th, 7th	"
441	12.....	.20	2.00	"	"	6th	Gilded
1823	89 to 91, 99.....	.40	4.00	"	3/4 Pl.	8th, 9th	Steel
1823	130, 131, 134.....	.35	3.50	"	"	"	"
440	15.....	.50	5.00	16	"	1st	"
440	17.....	.40	4.00	"	"	"	"
442	21.....	.50	5.00	"	"	2d	"
442	22.....	.40	4.00	"	"	"	"
441	18.....	.20	2.00	"	"	1st	Gilded
1331	32 to 41, 92 to 95, 98, 102, 125, 127.....	.35	3.50	"	"	6th to 9th, 13th	Steel
1331	107 to 110.....	.25	2.50	"	"	6th, 7th	"
2577	98, 126, 132.....	.40	4.00	"	"	14th, 15th, 17th	"
2577	102.....	.35	3.50	"	"	15th	"
1331	109, 110.....	.25	2.50	"	"	6th, 7th	"
1824	128, 129.....	.35	3.50	14	"	2d	"
1824	67 to 74, 87, 88, 100, 101, 111 to 114.....	.35	3.50	12	"	2d, 3d	"
2746	135.....	.50	5.00	"	"	4th	"
1546	53, 54.....	.50	5.00	6	"	2d	Gold
2330	53, 56.....	.35	3.50	"	"	"	Steel
1547	57, 58.....	.50	5.00	6	"	1st	Gold
2331	57, 60.....	.35	3.50	"	"	"	Steel
1825	76, 77, 80, 81, 116, 117.....	.35	3.50	"	"	2d, 3d	"

No. 432, 433, 1544  Htg. or O. F.	No. 435, 1563  Htg. or O. F.	No. 440, 441  Htg. or O. F.	No. 442  Htg. or O. F.	No. 1331  Htg. or O. F.
No. 1546, 2330  Htg.	No. 1547, 2331  Htg.	No. 1823  Htg. or O. F.	No. 1824  Htg. or O. F.	No. 1825  Htg. or O. F.
	No. 2577  Htg. or O. F.	No. 2746  O. F.		

Your Jobber will supply Balance Staffs, Balance Jewels, Roller Jewels. Hands and Screws in Dozen lots in original Sealed Trade Marked packages.

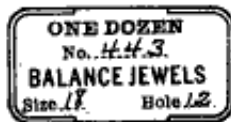

TRADE-MARKED PACKAGE



[top]

[bottom]

JEWELS, BALANCE HOLE UPPER

Catalogue No.	CLASS	PRICE		DESCRIPTION OF MOVEMENT			SETTINGS		
		Piece	Per Doz.	Size	Model	Kind	Diam.		
* 2578	1, 65.....	.25	2.50	18	F. Pl.	2d to 4th	Pale Ruby	Comp.	.116
* 2579	118 to 121.....	.25	2.50	"	"	10th, 11th	"	"	.084
443	1 to 11, 61 to 66, 103 to 106, 122 to 124.....	.20	2.00	"	"	1st to 5th, 7th	"	"	.116
447	12 to 14.....	.20	2.00	"	3/4 Pl.	6th	"	"	.096
†*2086	89, 90, 99.....	.30	3.00	"	"	8th, 9th	"	"	.096
* 2580	91, 134.....	.25	2.50	"	"	8th	"	"	.096
447	90, 91, 99, 130, 131.....	.20	2.00	"	"	8th, 9th	"	"	.096
443	15.....	.20	2.00	17	F. Pl.	1st, 2d	"	"	.116
1332	16, 21.....	.40	4.00	16	3/4 Pl.	"	"	Gold	.096
†*2086	41, 98, 126, 132.....	.30	3.00	"	"	7th, 13th to 15th	"	Comp.	.096
* 2580	98, 102, 126.....	.25	2.50	"	"	13th to 15th, 17th	"	"	.096
447	17 to 20, 22 to 41, 62 to 95.....	.20	2.00	"	"	1st to 7th	"	"	.096
447	98, 102, 107 to 110, 125, 127.....	.20	2.00	"	"	6th to 9th	"	"	.096
447	42, 43.....	.20	2.00	14	"	1st	"	"	.096
453	128, 129.....	.20	2.00	"	"	2d	"	"	.084
453	44, 45, 67 to 74, 87, 88.....	.20	2.00	12	"	1st to 3d	"	"	.084
453	100, 101, 111 to 114.....	.20	2.00	"	"	2d, 3d	"	"	.084
†*2926	135.....	.30	3.00	"	"	4th	"	"	.084
453	46 to 48.....	.20	2.00	10	"	1st	"	"	.084
453	49 to 56, 75, 115.....	.20	2.00	6	"	1st, 2d	"	"	.084
455	57 to 60, 76 to 86, 116, 117.....	.20	2.00	0	"	1st to 3d	"	"	.076
2189	133, 136.....	.20	2.00	5/0	"	1st, 2d	"	"	.054
2189	96, 97.....	.20	2.00	10/0	"	1st	"	"	.054

* Olive Holes.

† Settings stripped and polished.

JEWELS, BALANCE HOLE LOWER

Catalogue No.	CLASS	PRICE		DESCRIPTION OF MOVEMENT			SETTINGS		
		Piece	Per Doz.	Size	Model	Kind	Diam.		
* 2578	1, 65, 118 to 121.....	.25	2.50	18	F. Pl.	2d to 4th, 7th, 10th, 11th	Pale Ruby	Comp.	.116
443	1 to 11, 61 to 66, 103 to 106, 122 to 124.....	.20	2.00	"	"	1st to 5th, 7th	"	"	.116
447	12 to 14.....	.20	2.00	"	3/4 Pl.	6th	"	"	.096
†*2086	89, 90, 99.....	.30	3.00	"	"	8th, 9th	"	"	.096
* 2580	91, 134.....	.25	2.50	"	"	8th	"	"	.096
447	90, 1, 99, 130, 131.....	.20	2.00	"	"	8th, 9th	"	"	.096
443	15.....	.20	2.00	17	F. Pl.	1st, 2d	"	"	.116
1332	16, 21.....	.40	4.00	16	3/4 Pl.	"	"	Gold	.096
†*2086	41, 98, 126, 132.....	.30	3.00	"	"	7th, 13th to 15th	"	Comp.	.096
* 2580	98, 102, 126.....	.25	2.50	"	"	13th to 15th, 17th	"	"	.096
447	17 to 20, 22 to 41, 62 to 95.....	.20	2.00	"	"	1st to 7th	"	"	.096
447	98, 102, 107 to 110, 125, 127.....	.20	2.00	"	"	6th to 9th	"	"	.096
447	42, 43.....	.20	2.00	14	"	1st	"	"	.096
453	128, 129.....	.20	2.00	"	"	2d	"	"	.084
453	44, 45, 67 to 74, 87, 88.....	.20	2.00	12	"	1st to 3d	"	"	.084
453	100, 101, 111 to 114.....	.20	2.00	"	"	2d, 3d	"	"	.084
2926	135.....	.30	3.00	"	"	4th	"	"	.084
453	46 to 48.....	.20	2.00	10	"	1st	"	"	.084
453	49 to 56, 75, 115.....	.20	2.00	6	"	1st, 2d	"	"	.084
455	57 to 60, 76 to 86, 116, 117.....	.20	2.00	0	"	1st to 3d	"	"	.076
2189	133, 136.....	.20	2.00	5/0	"	1st, 2d	"	"	.054
2189	96, 97.....	.20	2.00	10/0	"	1st	"	"	.054

* Olive Holes.

† Settings stripped and polished.

‡ The shoulders of No. 453 as used in the lower plates of 12 size watches having double rollers, are .002 of an inch thinner than those used in the cock.

All Jewels in settings are supplied shouldered and the prices quoted are for finished settings.

In ordering unset Jewels state the size.

Balance Jewels will be supplied with assorted size holes or in separate sizes as ordered.

Pale Ruby Balance Hole Jewels (Cock & Foot) unset, \$1.50 doz.

Pale Ruby Balance Hole Jewels (Cock & Foot) Olive Holes unset, \$2.00 dozen.

JEWELS, BALANCE CAP
UPPER

Catalogue No.	CLASS	PRICE		DESCRIPTION OF MOVEMENT			Settings	Settings	
		Piece	Per Doz.	Size	Model	Kind		Diam.	
1347	1, 7, 65	.40	4.00	18	F. Pl.	1st to 5th, 7th	Rosy Ruby	Gold	.116
* 467	119, 121	.40	4.00	"	"	10th, 11th	"	"	.084
2927	119, 121	.30	3.00	"	"	"	Pale Ruby	"	.084
2191	1 to 11, 61 to 66, 103 to 106, 122 to 124	.15	1.25	"	"	2d to 5th, 7th	"	Comp.	.116
*2193	118 to 121	.15	1.25	"	"	10th, 11th	"	"	.084
2192	12 to 14	.15	1.25	"	3/4 Pl.	6th	"	"	.096
2071	89	.60	7.00	"	"	8th	Rosy	Gold	.096
2087	90, 91, 99	.40	4.00	"	"	8th, 9th	"	"	.096
2902	89	1.70	20.00	"	"	8th	Diamond	"	.096
2581	90, 91, 99	1.45	17.00	"	"	8th, 9th	"	"	.096
2192	130, 131	.15	1.25	"	"	8th	Pale Ruby	Comp.	.096
1349	134	.40	4.00	"	"	1st, 2d	Rosy	Gold	.096
2191	15	.15	1.25	17	F. Pl.	6th, 7th	Pale	Comp.	.116
1351	36, 41	.75	8.50	16	3/4 Pl.	1st, 2d	Red	Gold	.096
460	16, 21	.50	5.50	"	"	15th	"	"	.096
1349	32, 37, 98, 102, 126, 126	.40	4.00	"	"	6th to 9th, 13th to 15th, 17th	Rosy	"	.096
2584	132	1.70	20.00	"	"	13th	Diamond	"	.096
2082	98	.60	7.00	"	"	1st to 6th	Rosy Ruby	"	.096
2192	17 to 20, 22 to 31, 33 to 35	.15	1.25	"	"	"	Pale	Comp.	.096
2192	38 to 40, 92 to 95, 107 to 110, 127	.15	1.25	"	"	6th, 7th, 9th	"	"	.096
465	42	.20	2.00	14	"	1st	Rosy	"	.096
2192	42, 43	.15	1.25	"	"	"	Pale	"	.096
2193	128, 129	.15	1.25	"	"	2d	"	"	.084
2073	67, 71	.75	8.50	12	"	2d, 3d	Red Ruby	Gold	.084
467	68, 72	.40	4.00	"	"	"	Rosy	"	.084
1352	44	.20	2.00	"	"	1st	"	Comp.	.084
2193	44, 45, 69, 70, 73, 74, 87, 88	.15	1.25	"	"	1st to 3d	Pale	"	.084
2193	100, 101, 111 to 114	.15	1.25	"	"	2d, 3d	"	"	.084
2839	135	.60	7.00	10	"	4th	Rosy	Gold	.084
2193	46 to 48	.15	1.25	10	"	1st	Pale	Comp.	.084
467	49, 53	.40	4.00	6	"	1st, 2d	Rosy	Gold	.084
1352	50, 54	.20	2.00	"	"	"	"	Comp.	.084
2193	50 to 52, 54 to 56, 75, 115	.15	1.25	"	"	"	Pale	"	.084
468	57, 76, 80	.40	4.00	0	"	1st to 3d	Rosy	Gold	.076
1355	58	.20	2.00	"	"	1st	"	Comp.	.076
2194	58 to 60, 77 to 79, 81 to 86, 116, 117	.15	1.25	"	"	1st to 3d	Pale	"	.076
2196	133, 136	.15	1.25	5/0	"	1st, 2d	"	"	.054
2195	96	.40	4.00	10/0	"	1st	Rosy	Gold	.054
2196	97	.15	1.25	"	"	"	Pale	Comp.	.054

* Raised Settings.

JEWELS, BALANCE CAP
LOWER

Catalogue No.	CLASS	PRICE		DESCRIPTION OF MOVEMENT			Settings	Settings	
		Piece	Per Doz.	Size	Model	Kind		Diam.	
1248	1 to 11, 61 to 66, 103 to 106, 118 to 124	.15	1.25	18	F. Pl.	1st to 5th, 7th, 10th, 11th	Pale Ruby	Comp.	.116
1350	12 to 14	.15	1.25	"	3/4 Pl.	6th	"	"	.096
2585	89 to 91, 99	1.15	14.00	"	"	8th, 9th	Diamond	"	.096
1350	89 to 91, 99, 130, 131, 134	.15	1.25	"	"	"	Pale Ruby	"	.096
1348	15	.15	1.25	17	F. Pl.	1st, 2d	"	"	.116
2585	132	1.15	14.00	16	3/4 Pl.	15th	Diamond	"	.096
2422	16, 21	.40	4.00	"	"	1st, 2d	Rosy Ruby	Gold	.096
1350	17 to 20, 22 to 41, 92 to 95	.15	1.25	"	"	1st to 7th	Pale	Comp.	.096
1350	98, 102, 107 to 110, 125 to 127	.15	1.25	"	"	6th to 9th, 13th to 15th, 17th	"	"	.096
1350	42, 43	.15	1.25	14	"	1st	"	"	.096
466	128, 129	.15	1.25	"	"	2d	"	"	.084
466	44, 45, 67 to 74, 87, 88	.15	1.25	12	"	1st to 3d	"	"	.084
466	100, 101, 111 to 114, 135	.15	1.25	"	"	2d to 4th	"	"	.084
466	46 to 48	.15	1.25	10	"	1st	"	"	.084
466	49 to 56, 75, 115	.15	1.25	6	"	1st, 2d	"	"	.084
1356	57 to 60, 76 to 86, 116, 117	.15	1.25	0	"	1st to 3d	"	"	.076
2190	133, 136	.15	1.25	5/0	"	1st, 2d	"	"	.054
2190	96, 97	.15	1.25	10/0	"	1st	"	"	.054

The settings of Train and Cap Jewels are cupped and polished.
In ordering unset Jewels state the size.
Pale Ruby Balance Cap (Endstones) unset 75c dozen.
Rosy Ruby Balance Cap (Endstones) unset \$1.50 dozen.

JEWELS, BARREL ARBOR UPPER

Catalogue No.	CLASS	PRICE		DESCRIPTION OF MOVEMENT				SETTINGS	
		Piece	Per Doz.	Size	Model			Kind	Diam.
2085	89, 91.....	1.10	13.00	18	1/2 Pl.	8th	Rosy Ruby	Gold	.160
2928	41.....	1.45	17.00	16	"	7th	Red	"	.156
2586	98, 126, 132.....	1.10	13.00	"	"	13th to 15th, 17th	Rosy	"	.156
2186	67, 71.....	1.45	17.00	12	"	2d, 3d	Red	"	.140
2187	68, 72.....	1.10	13.00	"	"	"	Rosy	"	.140
2188	75, 80.....	1.10	13.00	0	"	"	"	"	.092

JEWELS, BARREL ARBOR LOWER

Catalogue No.	CLASS	PRICE		DESCRIPTION OF MOVEMENT				SETTINGS	
		Piece	Per Doz.	Size	Model			Kind	Diam.
2084	89, 91.....	.85	10.00	18	3/4 Pl.	8th	Sapphire	Comp.	.170
2587	41, 98, 126, 132.....	.85	10.00	16	"	7th, 13th to 15th, 17th	"	"	.156
2183	67, 71.....	.85	10.00	12	"	2d, 3d	Pale Ruby	"	.140
2184	68, 72.....	.85	10.00	"	"	"	Sapphire	"	.140
2185	75, 80.....	.85	10.00	0	"	"	Pale Ruby	"	.096

JEWELS, SWEEP SECOND ARBOR UPPER

Catalogue No.	CLASS	PRICE		DESCRIPTION OF MOVEMENT				SETTINGS	
		Piece	Per Doz.	Size	Model			Kind	Diam.
2181	27, 28.....	.40	4.00	16	1/2 Pl.	4th	Pale Ruby	Comp.	.126
545	27, 28.....	.30	3.00	"	"	"	Garnet	"	.126

JEWELS, CENTER UPPER

Catalogue No.	CLASS	PRICE		DESCRIPTION OF MOVEMENT				SETTINGS	
		Piece	Per Doz.	Size	Model			Kind	Diam.
1333	1, 7, 65, 119, 121.....	1.00	12.00	18	F. Pl.	2d to 4th, 7th, 10th, 11th	Rosy Ruby	Gold	.116
1335	1 to 4, 7 to 9, 66.....	.75	9.00	"	"	1st to 5th, 7th	"	Comp.	.126
2209	1, 3 to 5, 9, 10, 62, 64, 65, 103 to 105.....	.75	9.00	"	"	"	"	"	.116
2209	118, 120, 122 to 124.....	.75	9.00	"	"	10th, 11th	"	"	.116
2090	89 to 91, 99, 134.....	1.00	12.00	"	1/2 Pl.	8th, 9th	"	Gold	.116
1333	90.....	1.00	12.00	"	"	8th	"	"	.116
2209	130, 131.....	.75	9.00	"	"	8th, 9th	"	Comp.	.116
1338	36, 41.....	1.25	15.00	16	"	6th, 7th	Red Ruby	Gold	.126
2210	36, 41.....	1.25	15.00	"	"	"	"	"	.116
1336	32, 37, 41, 98, 102, 125, 126, 132.....	1.00	12.00	"	"	6th to 9th, 13th to 15th, 17th	Rosy Ruby	"	.116
517	16, 21.....	.85	10.00	"	"	1st, 2d	Pale	"	.126
2209	33, 34, 38, 39, 107 to 110, 127.....	.75	9.00	"	"	6th, 7th, 9th	Rosy	Comp.	.116
2213	128, 129.....	.75	9.00	14	"	2d	"	"	.106
2211	67, 71.....	1.25	15.00	12	"	2d, 3d	Red	Gold	.106
2212	68, 72, 135.....	1.00	12.00	"	"	2d to 4th	Rosy	"	.106
2213	69, 73, 100, 101, 111 to 114.....	.75	9.00	"	"	2d, 3d	"	Comp.	.106
519	49, 53.....	1.00	12.00	6	"	1st, 2d	"	Gold	.122
2213	56.....	.75	9.00	"	"	2d	"	Comp.	.108
2214	54, 56.....	.75	9.00	"	"	"	"	"	.096
520	57.....	1.00	12.00	0	"	1st	"	Gold	.086
2215	76, 77, 80, 81.....	1.00	12.00	"	"	2d, 3d	"	"	.086
1340	58.....	.75	9.00	"	"	1st	"	Comp.	.086
2216	60, 77, 81.....	.75	9.00	"	"	1st to 3d	"	"	.086
2217	56.....	1.00	12.00	10/0	"	1st	"	Gold	.080

The method of jewelling our movements enables you to replace a Jewel and retain the same "Endshake" as originally. The shoulders on the settings are cut the same for both upper and lower jewels, the variation in length of pivots being taken up in the depth of recess cut in the top pieces.

All Jewels in settings are supplied shouldered and the prices quoted are for finished settings.

JEWELS, CENTER
LOWER

Catalogue No.	CLASS	PRICE		DESCRIPTION OF MOVEMENT			SETTINGS		
		Piece	Per Doz.	Size	Model	Kind	Diam.		
1341	1 to 5, 7 to 10, 62, 64 to 66, 103 to 106, 118 to 124	.50	6.00	18	F. Pl.	2d to 5th, 7th, 10th, 11th	Sapphire	Unset	
2080	89 to 91, 99, 130, 131, 134	.65	7.50	"	3/4 Pl.	8th, 9th	"	Comp.	.116
1343	32 to 34, 37 to 39, 41, 98, 102, 107 to 110	.65	7.50	16	"	6th to 9th, 13th to 15th	"	"	.116
1343	125 to 127, 132	.65	7.50	"	"	13th to 15th, 17th	"	"	.116
1344	36, 41, 98, 102	.75	8.50	"	"	6th, 7th, 9th	Pale Ruby	"	.116
2205	32, 36 to 39, 41	.75	8.50	"	"	6th, 7th	"	"	.116
1342	16, 21	.60	7.00	"	"	1st, 2d	"	Unset	
2207	128, 129	.65	7.50	14	"	2d	Sapphire	Comp.	.106
2206	67, 71	.75	8.50	12	"	2d, 3d	Pale Ruby	"	.106
2207	68, 69, 72, 73, 100, 101, 111 to 114, 135	.65	7.50	"	"	2d to 4th	Sapphire	"	.106
1345	49, 53	.75	8.50	6	"	1st, 2d	Pale Ruby	"	.086
1346	57, 76, 77, 80, 81	.75	8.50	0	"	1st to 3d	"	"	.086
2208	96	.60	7.00	10/0	"	1st	"	Unset	

JEWELS, ESCAPE
UPPER

Catalogue No.	CLASS	PRICE		DESCRIPTION OF MOVEMENT			SETTINGS		
		Piece	Per Doz.	Size	Model	Kind	Diam.		
2224	1, 2, 65, 119, 121	.55	6.50	18	F. Pl.	1st to 5th, 7th, 10th, 11th	Rosy Ruby	Gold	.116
1363	1, 7	.50	5.00	"	"	1st to 5th	"	Comp.	.126
2225	1	.50	5.00	"	"	1st to 4th	"	"	.116
1364	1, 7, 65, 106, 119, 121 Cap'd	.20	2.00	"	"	1st to 5th, 7th, 10th, 11th	Pale Ruby	"	.116
1365	1 to 5, 7 to 10, 66	.30	3.00	"	"	1st to 5th, 7th	Garnet	"	.126
2226	4, 5, 9, 10, 61 to 64, 103 to 106	.30	3.00	"	"	"	"	"	.116
2226	118, 120, 122 to 124	.30	3.00	"	"	10th, 11th	"	"	.116
1366	4, 5, 10	.15	1.50	"	"	1st to 5th	"	Unset	
1368	12	.30	3.00	"	3/4 Pl.	6th	"	Comp.	.096
1369	13	.15	1.50	"	"	"	"	Unset	
2224	91	.55	6.50	"	"	8th	Rosy Ruby	Gold	.116
2226	130, 131	.30	3.00	"	"	8th, 9th	Garnet	Comp.	.116
2091	89 to 91, 99, 134 Cap'd	.20	2.00	"	"	"	Pale Ruby	"	.116
1370	32, 37, 98, 102, 125, 126	.55	6.50	16	"	6th, 7th, 9th, 13th to 15th	Rosy Ruby	Gold	.096
472	16, 21	.45	4.50	"	"	1st, 2d	Pale Ruby	"	.126
1367	17, 22	.50	5.00	"	"	"	Rosy Ruby	Comp.	.096
2227	36, 41	.20	2.00	"	"	6th, 7th	Pale Ruby	"	.106
1371	36, 41, 98, 126, 132	.40	4.00	"	"	6th to 7th, 13th to 15th, 17th	"	"	.096
1368	17, 18, 24 to 31, 33 to 35, 38 to 40	.30	3.00	"	"	1st, 3d to 6th	Garnet	"	.096
1368	92 to 95, 107 to 110, 125 to 127	.30	3.00	"	"	6th to 9th, 17th	"	"	.096
1369	20, 22, 23, 26, 31	.15	1.50	"	"	1st to 3d, 5th	"	Unset	
1367	42	.50	5.00	14	"	1st	Rosy Ruby	Comp.	.096
1368	43, 128, 129	.30	3.00	"	"	1st, 2d	Garnet	"	.096
1370	68, 72, 135	.55	6.50	12	"	2d to 4th	Rosy Ruby	Gold	.096
478	44	.50	5.00	"	"	1st	"	Comp.	.096
2228	67, 68, 71, 72, 135	.20	2.00	"	"	2d to 4th	Pale Ruby	"	.096
1368	45, 69, 70, 73, 74, 87, 88	.30	3.00	"	"	1st to 3d	Garnet	"	.096
1368	100, 101, 111 to 114	.30	3.00	"	"	2d, 3d	"	"	.096
478	46	.50	5.00	10	"	1st	Rosy Ruby	"	.096
1373	48	.30	3.00	"	"	"	Garnet	"	.096
1372	47	.15	1.50	"	"	"	"	Unset	
479	49, 53	.35	6.50	6	"	1st, 2d	Rosy Ruby	Gold	.126
1374	50, 54	.50	5.00	"	"	"	"	Comp.	.096
1375	50, 51, 55, 56, 75, 115	.30	3.00	"	"	"	Garnet	"	.096
1376	52, 56	.15	1.50	"	"	"	"	Unset	
480	57	.55	6.50	0	"	1st	Rosy Ruby	Gold	.096
2229	76, 80	.55	6.50	"	"	2d, 3d	"	"	.080
2230	58, 77, 81	.50	5.00	"	"	1st to 3d	"	Comp.	.080
1378	89, 90, 78, 82, 84 to 86, 116, 117	.30	3.00	"	"	"	Garnet	"	.080
1379	60	.15	1.50	"	"	1st	"	Unset	
2232	133, 136	.30	3.00	5/0	"	1st, 2d	"	Comp.	.060
2231	96	.55	6.50	10/0	"	1st	Rosy Ruby	Gold	.060
2232	96, 97	.30	3.00	"	"	"	Garnet	Comp.	.060

All Jewels in settings are supplied shouldered and the prices quoted are for finished settings.

Should train Jewels with unfinished settings be required the price will be \$1.00 per dozen less than list for composition and \$2.00 per dozen less than list for gold.

All orders will be filled with flat or flush settings, unless it is stated that raised settings are wanted, the price being the same.

JEWELS, ESCAPE LOWER

Catalogue No.	CLASS	PRICE		DESCRIPTION OF MOVEMENT			Settings	SETTINGS	
		Piece	Per Doz.	Size	Model			Kind	Diam.
					F. Pl.	Model			
2218	1, 7, 65, 119, 121	.40	4.00	18	F. Pl.	1st to 5th, 7th, 10th, 11th	Pale Ruby	Comp.	.116
1380	1, 7, 65, 106, 119, 121 Capped	.20	2.00	"	"	"	"	"	.116
481	1 to 5, 7 to 10, 66	.30	3.00	"	"	1st to 5th, 7th	Garnet	"	.126
2219	4, 5, 9, 10, 61 to 64, 103 to 106	.30	3.00	"	"	"	"	"	.116
2219	118, 120, 122 to 124	.30	3.00	"	"	"	"	"	.116
486	12	.30	3.00	"	3/4 Pl.	10th, 11th	"	"	.096
2218	91, 134	.40	4.00	"	"	8th	Pale Ruby	"	.116
1380	89, 90, 99, 134 Capped	.20	2.00	"	"	8th, 9th	"	"	.116
2219	130, 131	.30	3.00	"	"	"	Garnet	"	.116
484	16, 21 Capped	.40	4.00	16	"	1st, 2d	Pale Ruby	Gold Comp.	.096
1381	17, 22, 32, 37, 98, 102, 125, 126	.40	4.00	"	"	1st, 2d, 6th to 9th, 13th to 15th, 17th	"	"	.088
2220	32, 37, 98, 102, 125, 126	.40	4.00	"	"	6th to 9th, 13th to 15th	"	"	.088
2182	36, 41, 98, 126, 132 Capped	.20	2.00	"	"	6th, 7th, 9th, 13th to 15th, 17th	"	"	.096
486	17, 18, 22 to 31, 33 to 35, 38 to 40	.30	3.00	"	"	1st to 7th	Garnet	"	.096
486	92 to 95, 107 to 110, 126	.30	3.00	"	"	6th, 7th, 9th	"	"	.096
2221	51, 53 to 55, 58 to 60	.30	3.00	"	"	5th to 7th	"	"	.088
2221	92 to 95, 107 to 110, 126	.30	3.00	"	"	6th, 7th, 9th	"	"	.088
1381	42	.40	4.00	14	"	1st	Pale Ruby	"	.096
1382	43, 128, 129	.30	3.00	"	"	1st, 2d	Garnet	"	.096
2221	128, 129	.30	3.00	"	"	2d	"	"	.088
490	44, 68, 72, 135	.40	4.00	12	"	1st to 4th	Pale Ruby	"	.096
2220	68, 72	.40	4.00	"	"	2d, 3d	"	"	.088
2182	67, 68, 71, 72, 135 Capped	.20	2.00	"	"	2d to 4th	"	"	.096
1382	45, 69, 70, 73, 74, 87, 88	.30	3.00	"	"	1st to 3d	Garnet	"	.096
1382	100, 101, 111 to 114	.30	3.00	"	"	2d, 3d	"	"	.096
2221	69, 70, 73, 74, 87, 88	.30	3.00	"	"	"	"	"	.088
2221	100, 101, 111 to 114	.30	3.00	"	"	"	"	"	.088
490	40	.40	4.00	10	"	1st	Pale Ruby	"	.096
1382	47, 48	.30	3.00	"	"	"	Garnet	"	.096
491	49, 50, 53, 54	.40	4.00	6	"	1st, 2d	Pale Ruby	"	.096
1383	50, 51, 55, 56	.30	3.00	"	"	"	Garnet	"	.096
2221	56, 75, 115	.30	3.00	"	"	2d	"	"	.688
492	57, 58, 76, 77, 80, 81	.40	4.00	0	"	1st to 3d	Pale Ruby	"	.080
1384	59, 60, 78, 82, 84 to 86, 116, 117	.30	3.00	"	"	"	Garnet	"	.080
2223	133, 136	.30	3.00	5/0	"	1st, 2d	"	"	.054
2938	133, 136	.30	3.00	"	"	"	"	"	.060
2222	96	.40	4.00	10/0	"	1st	Pale Ruby	"	.054
2939	96	.40	4.00	"	"	"	"	"	.060
2223	96, 97	.30	3.00	"	"	"	Garnet	"	.054
2938	96, 97	.30	3.00	"	"	"	"	"	.060

JEWELS, ESCAPE CAP UPPER

Catalogue No.	CLASS	PRICE		DESCRIPTION OF MOVEMENT			Settings	SETTINGS	
		Piece	Per Doz.	Size	Model			Kind	Diam.
					F. Pl.	Model			
1357	1, 7, 65, 119, 121	.40	4.00	18	F. Pl.	2d to 5th, 7th, 10th, 11th	Rosy Ruby	Gold	.116
2929	106	.15	1.25	"	"	5th	Pale Ruby	Comp.	.116
1357	134	.40	4.00	"	3/4 Pl.	8th	Rosy Ruby	Gold	.116
2088	89 to 91, 99	.40	4.00	"	"	8th, 9th	"	"	.116
2197	16	.50	5.50	16	"	1st	Red Ruby	"	.144
2423	21	.50	5.50	"	"	2d	"	"	.106
1359	36, 41	.50	5.50	"	"	6th, 7th	"	"	.106
2198	41	.50	5.50	"	"	7th	"	"	.096
2199	98, 126, 132	.40	4.00	"	"	9th, 13th to 15th, 17th	Rosy Ruby	"	.096
2198	67, 71	.50	5.50	12	"	2d, 3d	Red Ruby	"	.096
2199	68, 72, 135	.40	4.00	"	"	2d to 4th	Rosy Ruby	"	.096

JEWELS, ESCAPE CAP LOWER

Catalogue No.	CLASS	PRICE		DESCRIPTION OF MOVEMENT			Settings	SETTINGS	
		Piece	Per Doz.	Size	Model			Kind	Diam.
					F. Pl.	Model			
1360	1, 7, 65, 119, 121	.15	1.25	18	F. Pl.	2d to 5th, 7th, 10th, 11th	Pale Ruby	Comp.	.116
1360	89 to 91, 99, 134	.15	1.25	"	3/4 Pl.	8th, 9th	"	"	.116
1361	16, 21	.40	4.00	16	"	1st, 2d	Rosy Ruby	Gold	.096
1362	36, 41, 98, 126, 132	.15	1.25	"	"	6th, 7th, 9th, 13th to 15th	Pale Ruby	Comp.	.096
1362	67, 68, 71, 72, 135	.15	1.25	12	"	2d to 4th	"	"	.096

Under the head "Settings" the extreme diameter of setting is given in thousandths part of an inch.

JEWELS, FOURTH UPPER

Catalogue No.	CLASS	PRICE		DESCRIPTION OF MOVEMENT		SETTINGS	
		Piece	Per Doz.	Size	Model	Kind	Dim.
1385	1, 7, 65, 119, 121.....	.55	6.50	18	F. Pl. 1st to 5th, 7th, 10th, 11th	Rosy Ruby	Gold .116
1386	1, 7.....	.50	5.00	"	" 1st to 5th	" Comp. .126	
2238	1.....	.50	5.00	"	" 1st to 4th	" " .116	
1387	1 to 5, 7 to 10, 66.....	.30	3.00	"	" 1st to 5th, 7th	Garnet " .125	
2239	4, 5, 9, 10, 61 to 64, 103 to 106.....	.30	3.00	"	" " " " " "	" " " .116	
2239	118, 120, 122 to 124.....	.30	3.00	"	" 2d to 5th, 7th, 10th, 11th	" " " .116	
1388	4, 5, 10.....	.15	1.50	"	" 1st to 5th	" Unset Comp. .086	
1390	12.....	.30	3.00	"	" 6th	" " " .086	
1391	13.....	.15	1.50	"	" " " " " "	" " " " " .116	
2092	89 to 91, 99, 134.....	.55	6.50	"	" 8th 9th	Rosy Ruby Gold .116	
2239	130, 131.....	.30	3.00	"	" " " " " "	Garnet Comp. .116	
496	16, 21.....	1.00	12.00	16	" 1st, 2d	Red Ruby Gold .144	
2240	36, 41.....	1.00	12.00	"	" 6th, 7th	" " " .116	
1393	36, 41.....	1.00	12.00	"	" " " " " "	" " " " " .086	
1392	32, 37, 98, 102, 125, 126, 132.....	.55	6.50	"	" 6th to 9th, 13th to 15th, 17th	Rosy Ruby " .086	
1389	17, 22.....	.50	5.00	"	" 1st, 2d	" Comp. .086	
1390	17, 18, 24 to 31, 33 to 35.....	.30	3.00	"	" 1st, 3d to 6th	Garnet " .086	
1390	38 to 40, 92 to 95, 107 to 110, 127.....	.30	3.00	"	" 6th, 7th, 9th	" " " .086	
1391	20, 22, 23, 26, 31.....	.15	1.50	"	" 1st to 3d, 5th	" Unset Comp. .086	
1389	42.....	.50	5.00	14	" 1st	Rosy Ruby Comp. .086	
1390	43, 128, 129.....	.30	3.00	"	" 1st, 2d	Garnet " .086	
2241	67, 1.....	1.00	12.00	12	" 2d, 3d	Red Ruby Gold .086	
1392	68, 72, 135.....	.55	6.50	"	" 2d to 4th	Rosy Ruby " .086	
502	44.....	.50	5.00	"	" 1st	" Comp. .086	
1390	45, 69, 70, 73, 74, 87, 88.....	.30	3.00	"	" 1st to 3d	Garnet " .086	
1390	100, 101, 111 to 114.....	.30	3.00	"	" 2d, 3d	" " .086	
502	46.....	.50	5.00	10	" 1st	Rosy Ruby " .086	
1395	48.....	.30	3.00	"	" " " " " "	Garnet " " .086	
1394	47.....	.15	1.50	"	" " " " " "	" " " " " .126	
503	49, 53.....	.55	6.50	6	" 1st, 2d	Rosy Ruby Gold Comp. .086	
1396	50, 54.....	.50	5.00	"	" " " " " "	" " " " " .086	
1397	50, 51, 55, 56, 75, 115.....	.30	3.00	"	" " " " " "	Garnet " " .086	
1398	52, 56.....	.15	1.50	"	" " " " " "	" " " " " .086	
504	57.....	.55	6.50	0	" 1st	Rosy Ruby Gold .086	
2242	75, 77, 80, 81.....	.55	6.50	"	" 2d, 3d	" " .080	
1399	58, 77, 81.....	.50	5.00	"	" 1st to 3d	" Comp. .080	
1400	59, 60, 78, 82, 84 to 86, 116, 117.....	.30	3.00	"	" " " " " "	Garnet " " .080	
1401	60.....	.15	1.50	"	" 1st	" Unset Comp. .060	
2245	133, 136.....	.30	3.00	5/0	" 1st, 2d	" " " .060	
2244	96.....	.55	6.50	10/0	" 1st	Rosy Ruby Gold .080	
2245	97.....	.30	3.00	"	" " " " " "	Garnet Comp. .060	

The method of jewelling our movements enables you to replace a Jewel and retain the same "Endshake" as originally. The shoulders on the settings are cut the same for both upper and lower jewels, the variation in length of pivots being taken up in the depth of recess cut in the top pieces.

All Jewels in settings are supplied shouldered and the prices quoted are for finished settings.

The settings of Train and Cap jewels are cupped and polished.

Under the head "settings" the extreme diameter of setting is given in thousandths part of an inch.

All orders will be filled with flat or flush settings, unless it is stated that raised settings are wanted, the price being the same.

Unless Unfinished settings are mentioned finished will be sent.

Should train jewels with unfinished settings be required the price will be \$1.00 per dozen less than list for composition and \$2.00 per dozen less than list for gold.

JEWELS, FOURTH LOWER

Catalogue No.	CLASS	PRICE		DESCRIPTION OF MOVEMENT			SETTINGS	
		Piece	Per Doz.	Size	Model	Kind	Diam.	
1402	1, 7, 65, 106, 119, 121.....	.40	4.00	18	F. Pl.	1st to 5th, 7th, 10th, 11th	Pale Ruby	Comp. .114
505	1 to 5, 7 to 10, 66.....	.30	3.00	"	"	1st to 5th, 7th	Garnet	" .126
2233	4, 5, 9, 10, 61 to 64, 103 to 106	.30	3.00	"	"	1st to 5th	"	" .116
2233	118, 120, 122 to 124.....	.30	3.00	"	"	2d to 4th, 7th, 10th, 11th	"	" .116
510	12.....	.30	3.00	"	3/4 Pl.	6th	"	" .096
1402	89 to 91, 99, 134.....	.40	4.00	"	"	8th, 9th	Pale Ruby	" .116
2233	130, 131.....	.30	3.00	"	"	"	Garnet	" .116
508	16, 21.....	.55	6.50	16	"	1st, 2d	Rose Ruby	Gold .096
1403	17, 22, 32, 36, 37, 41, 98, 126, 132	.40	4.00	"	"	1st, 2d, 14th, 7th, 13th, 15th, 17th	Pale Ruby	Comp. .096
2234	32, 37, 98, 102, 125, 126.....	.40	4.00	"	"	6th to 9th, 13th to 15th	"	" .088
510	17, 18, 22 to 31, 33 to 35, 38 to 40	.30	3.00	"	"	1st to 7th	Garnet	" .096
510	107 to 110, 127.....	.30	3.00	"	"	6th, 7th, 9th	"	" .096
2235	31, 33 to 35, 38 to 40, 92 to 95	.30	3.00	"	"	5th to 7th	"	" .088
2235	107 to 110, 127.....	.30	3.00	"	"	6th, 7th, 9th	"	" .088
1403	42.....	.40	4.00	14	"	1st	Pale Ruby	" .096
510	43.....	.30	3.00	"	"	"	Garnet	" .096
2235	128, 129.....	.30	3.00	"	"	2d	"	" .088
1405	128, 129.....	.30	3.00	"	"	"	"	" .096
514	44, 67, 68, 1, 72, 135.....	.40	4.00	12	"	1st to 4th	Pale Ruby	" .096
2234	68, 72.....	.40	4.00	"	"	2d, 3d	"	" .088
1405	45, 69, 70, 73, 74, 87, 88.....	.30	3.00	"	"	1st to 3d	Garnet	" .096
1405	100, 101, 111 to 114.....	.30	3.00	"	"	2d, 3d	"	" .096
2235	69, 70, 73, 74, 87, 88.....	.30	3.00	"	"	"	"	" .088
2235	100, 101, 111 to 114.....	.30	3.00	"	"	"	"	" .088
514	46.....	.40	4.00	10	"	1st	Pale Ruby	" .096
1405	47, 48.....	.30	3.00	"	"	"	Garnet	" .096
514	49, 50, 53, 54.....	.40	4.00	6	"	1st, 2d	Pale Ruby	" .096
1405	51, 55, 56.....	.30	3.00	"	"	"	Garnet	" .096
2235	56, 75, 115.....	.30	3.00	"	"	2d	"	" .088
516	57, 58, 76, 77, 80, 81.....	.40	4.00	0	"	1st to 3d	Pale Ruby	" .080
1406	59, 60, 78, 82, 84 to 86, 116, 117	.30	3.00	"	"	"	Garnet	" .080
2237	133.....	.30	3.00	5/0	"	1st	"	" .054
2930	133, 136.....	.30	3.00	"	"	1st, 2d	"	" .060
2236	96.....	.40	4.00	10/0	"	1st	Pale Ruby	" .054
2931	96.....	.40	4.00	"	"	"	"	" .060
2237	97.....	.30	3.00	"	"	"	Garnet	" .054
2930	97.....	.30	3.00	"	"	"	"	" .060

TABLE OF JEWEL SETTING DIAMETERS

Showing their Sizes in Thousandths of an Inch and Equivalent Diameters in Millimeters

Inches	Millimeters.
.054.....	1.37
.060.....	1.52
.070.....	1.78
.076.....	1.93
.080.....	2.03
.084.....	2.13
.086.....	2.18
.088.....	2.23
.092.....	2.33
.096.....	2.43
.106.....	2.69
.116.....	2.94
.122.....	3.09
.126.....	3.20
.140.....	3.55
.144.....	3.65
.156.....	3.96
.160.....	4.06
.170.....	4.31

**JEWELS, PALLET
UPPER**

Catalogue No.	CLASS	PRICE		DESCRIPTION OF MOVEMENT			SETTINGS		
		Piece	Per Doz.	Size	Model	Kind	Diam.		
2257	1, 7, 65, 119, 121	.55	6.50	18	F. Pl.	1st to 5th, 7th, 10th, 11th	Rosy Ruby	Gold	.116
1407	1, 7	.50	5.00	"	"	1st to 5th	"	Comp.	.125
2258	1, 65	.50	5.00	"	"	1st to 4th, 7th	"	"	.116
1408	1, 7, 65, 106, 119, 121 Cap'd	.20	2.00	"	"	1st to 5th, 7th, 10th, 11th	Pale Ruby	"	.116
1410	1 to 5, 7 to 10, 66	.30	3.00	"	"	1st to 5th, 7th	Garnet	"	.126
2259	4, 5, 9, 10, 61 to 64, 103 to 106	.30	3.00	"	"	1st to 5th	"	"	.116
2259	118, 120, 122 to 124	.30	3.00	"	"	2d to 4th, 7th, 10th, 11th	"	"	.116
1411	4, 5, 10	.15	1.50	"	"	1st to 5th	"	Unset	"
1414	12, 13	.15	1.50	"	3/4 Pl.	6th	"	"	"
2260	91	.50	5.00	"	"	8th	Rosy Ruby	Comp.	.088
2261	91	.50	5.00	"	"	"	"	"	.080
2093	89 to 91, 99, 134, Capped	.20	2.00	"	"	8th, 9th	Pale Ruby	"	.088
2588	130, 131	.30	3.00	"	"	"	Garnet	"	.088
2036	130, 131	.30	3.00	"	"	"	"	"	.080
1412	16, 21	.55	5.50	16	"	1st, 2d	Pale Ruby	Gold	.096
2261	32, 37, 98, 102, 126	.50	5.00	"	"	6th, 7th, 9th, 14th, 15th, 17th	Rosy Ruby	Comp.	.080
2262	32, 37, 102, 125	.40	4.00	"	"	6th to 8th, 13th, 15th	Pale Ruby	"	.080
1413	17, 22, 32, 37	.25	2.50	"	"	1st, 2d, 6th, 7th	"	Unset	"
2093	36, 41, 98, 126, 132 Cap'd	.20	2.00	"	"	6th, 7th, 9th	"	Comp.	.086
2263	31, 32 to 35, 38 to 40	.30	3.00	"	"	13th to 15th, 17th	Garnet	"	.080
2263	92 to 95, 107 to 110, 127	.30	3.00	"	"	5th to 7th	"	"	.080
1414	17 to 20, 22 to 31, 33 to 35, 38 to 40	.15	1.50	"	"	6th, 7th, 9th	"	"	.080
1413	42	.25	2.50	14	"	1st to 7th	"	Unset	"
1414	43	.15	1.50	"	"	1st	Pale Ruby	"	"
2265	128, 129	.30	3.00	"	"	2d	Garnet	"	.070
2267	128, 129	.30	3.00	"	"	"	"	Comp.	.060
2264	68, 72	.55	6.50	12	"	2d, 3d	Rosy Ruby	Gold	.060
1416	44	.25	2.50	"	"	1st	Pale Ruby	Unset	"
2093	67, 68, 71, 72, 135 Capped	.20	2.00	"	"	2d to 4th	"	Comp.	.086
2265	69, 70, 73, 74, 87, 88	.30	3.00	"	"	2d, 3d	Garnet	"	.070
2265	100, 101, 111 to 114	.30	3.00	"	"	"	"	"	.070
2267	69, 70, 73, 74, 87, 88	.30	3.00	"	"	"	"	"	.060
2267	100, 101, 111 to 114	.30	3.00	"	"	"	"	"	.060
1417	45	.15	1.50	"	"	1st	"	Unset	"
2749	135	.55	5.50	"	"	4th	Pale Ruby	Gold	.060
1416	46	.25	2.50	10	"	1st	"	Unset	"
1417	47, 48	.15	1.50	"	"	"	Garnet	"	"
1418	49 to 56	.25	2.50	8	"	1st, 2d	Pale Ruby	"	"
2263	56, 75, 115	.30	3.00	"	"	2d	Garnet	Comp.	.080
2267	56, 75, 115	.30	3.00	"	"	"	"	"	.060
2266	77, 81	.40	4.00	0	3/4 Pl.	2d, 3d	Pale Ruby	Comp.	.060
1419	57 to 60, 76 to 78, 80 to 82	.25	2.50	"	"	1st to 3d	"	Unset	"
1419	84 to 86, 116, 117	.25	2.50	"	"	"	"	"	"
2267	85, 86, 116, 117	.30	3.00	"	"	2d, 3d	Garnet	Comp.	.060
2268	133, 136	.15	1.50	5/0	"	1st, 2d	"	Unset	"
2268	98, 97	.15	1.50	10/0	"	1st	"	"	"
2937	96	.25	2.50	"	"	"	Pale Ruby	"	"

**JEWELS, PALLET CAP
UPPER**

Catalogue No.	CLASS	PRICE		DESCRIPTION OF MOVEMENT			SETTINGS		
		Piece	Per Doz.	Size	Model	Kind	Diam.		
2204	1, 7, 65, 119, 121	.40	4.00	18	F. Pl.	2d to 5th, 7th, 10th, 11th	Rosy Ruby	Gold	.116
2203	89, 90, 91, 99, 134	.50	5.00	"	3/4 Pl.	8th, 9th	"	"	Clamp.
1358	16, 21, 36, 41	.60	7.00	16	"	1st, 2d, 6th, 7th	Red Ruby	"	"
2203	98, 126, 132	.50	5.00	"	"	9th, 13th to 15th, 17th	Rosy Ruby	"	"
2425	67, 71	.60	7.00	12	"	2d, 3d	Red Ruby	"	"
2203	68, 72, 135	.50	5.00	"	"	2d to 4th	Rosy Ruby	"	"

Your Jobber will supply Balance Staffs, Balance Jewels, Roller Jewels, Hands, and Screws in Dozen lots in original Sealed Trade Marked packages.



TRADE-MARKED PACKAGE



[top]

[bottom]

**JEWELS, PALLET
LOWER**

Catalogue No.	Class	Price		Description of Movement		Kind	Settings	
		Piece	Per Doz.	Size	Model		Kind	Diam.
2246	1, 7, 65, 119, 121.....	.40	4.00	18	F. Pl.	1st to 5th, 7th, 10th, 11th	Pale Ruby	Comp. .116
2249	1, 7, 65, 106, 119, 121 Cap'd	.20	2.00	"	"	"	"	.116
2247	1 to 5, 7 to 10, 66.....	.30	3.00	"	"	1st to 5th, 7th	Garnet	.126
2248	4, 5, 9, 10, 61 to 64, 103 to	.30	3.00	"	"	1st to 5th	"	.116
2248	106, 118, 120, 122 to 124.	.30	3.00	"	"	2d to 5th, 7th, 10th, 11th	"	.116
2426	12.....	.30	3.00	"	1/2 Pl.	6th	"	.096
2246	91, 134.....	.40	4.00	"	"	8th	Pale Ruby	.116
2249	90, 91, 99, 134..... Capped	.20	2.00	"	"	8th, 9th	"	.116
2249	89.....	.20	2.00	"	"	8th	"	.116
2248	130, 131.....	.30	3.00	"	"	8th, 9th	Garnet	.116
2427	16, 21..... Capped	.40	4.00	16	"	1st, 2d	Pale Ruby	Gold .096
2428	17, 22, 32, 36, 37, 41.....	.40	4.00	"	"	1st, 2d, 6th, 7th	"	Comp. .096
2428	98, 102, 125, 126.....	.40	4.00	"	"	8th, 13th to 15th	"	.096
2251	32, 37, 98, 102, 125, 126.	.40	4.00	"	"	6th to 9th, 13th to 15th	"	.088
2250	36, 41, 98, 126, 132 Capped	.20	2.00	"	"	6th, 7th, 9th, 13th to 15th, 17th	"	.096
2426	17, 18, 22 to 31, 33 to 35, 38 to 40.....	.30	3.00	"	"	1st to 7th	Garnet	.096
2426	92 to 95, 107 to 110, 125, 127.....	.30	3.00	"	"	6th to 9th	"	.096
2252	31, 33 to 35, 38 to 40, 92 to 95.....	.30	3.00	"	"	5th to 7th	"	.088
2252	107 to 110, 125, 127.....	.30	3.00	"	"	6th to 9th	"	.088
2428	42.....	.40	4.00	14	"	1st	Pale Ruby	.096
2426	43, 128, 129.....	.30	3.00	"	"	1st, 2d	Garnet	.096
2252	128, 129.....	.30	3.00	"	"	2d	"	.088
2428	44, 68, 72, 135.....	.40	4.00	12	"	1st to 4th	Pale Ruby	.096
2251	68, 72.....	.40	4.00	"	"	2d, 3d	"	.088
2250	67, 68, 71, 72, 135 Cap'd	.20	2.00	"	"	2d to 4th	"	.096
2426	45, 69, 70, 73, 74, 87, 88, 100, 101, 111 to 114.....	.30	3.00	"	"	1st to 3d	Garnet	.096
2252	69, 70, 73, 74, 87, 88, 100, 101, 111 to 114.....	.30	3.00	"	"	2d, 3d	"	.088
2428	46.....	.40	4.00	10	"	1st	Pale Ruby	.096
2426	47, 48.....	.30	3.00	"	"	"	Garnet	.096
2428	49, 50, 53, 54.....	.40	4.00	6	"	1st, 2d	Pale Ruby	.096
2426	50, 51, 55, 56, 75, 115.....	.30	3.00	"	"	"	Garnet	.096
2252	50, 51, 55, 56, 75, 115.....	.30	3.00	"	"	"	"	.088
2253	57, 58, 76, 77, 80, 81.....	.40	4.00	6	"	1st to 3d	Pale Ruby	.080
2254	59, 60, 78, 82, 84 to 86, 116, 117.....	.30	3.00	"	"	"	Garnet	.080
2256	133.....	.30	3.00	5/0	"	1st	"	.054
2243	133, 136.....	.30	3.00	"	"	1st, 2d	"	.050
2255	96.....	.40	4.00	10/0	"	1st	Pale Ruby	.054
2244	96.....	.40	4.00	"	"	"	"	.060
2256	97.....	.30	3.00	"	"	"	Garnet	.054
2243	97.....	.30	3.00	"	"	"	"	.060

**JEWELS, PALLET CAP
LOWER**

Catalogue No.	Class	Price		Description of Movement		Kind	Settings	
		Piece	Per Doz.	Size	Model		Kind	Diam.
2200	1, 7, 65, 119, 121.....	.15	1.25	18	F. Pl.	2d to 5th, 7th, 10th, 11th	Pale Ruby	Comp. .116
2200	89, 90, 91, 99, 134.....	.15	1.25	"	"	8th, 9th	"	.116
2424	16, 21.....	.40	4.00	16	1/2 Pl.	1st, 2d	Rosy Ruby	Gold .096
2202	36, 41, 98, 126, 132.....	.15	1.25	"	"	6th, 7th, 9th, 13th to 15th, 17th	Pale Ruby	Comp. .096
2202	67, 68, 71, 72, 135.....	.15	1.25	12	"	2d to 4th	Pale Ruby	.096

UNSET JEWELS; TRAIN, BALANCE AND CAP

Train Red Ruby.....	unset per doz.	9.00
" Rosy Ruby.....	"	3.50
" Pale Ruby.....	"	2.50
" Garnet.....	"	1.50
Balance Hole Ruby (straight holes).....	"	1.50
" (olived holes).....	"	2.00
" Cap Ruby.....	"	.75

When ordering unset jewels specify the size.

JEWELS, THIRD
UPPER

Catalogue No.	CLASS	PRICE		Size	DESCRIPTION OF MOVEMENT		Settings	
		Piece	Per Dos.				Kind	Diam.
1420	1, 7, 65, 119, 121	.55	6.50	18	F. Pl. 1st to 5th, 7th, 10th, 11th	Rosy Ruby	Gold	.116
1421	1, 7	.50	5.00	"	" 1st to 5th	"	Comp.	.126
2274	1, 65	.50	5.00	"	" 1st to 4th, 7th	"	"	.116
1422	1 to 5, 7 to 10, 66	.30	3.00	"	" 1st to 5th, 7th	Garnet	"	.126
2275	4, 5, 9, 10, 61 to 64, 103 to 106	.30	3.00	"	" 1st to 5th	"	"	.116
2275	118, 120, 122 to 124	.30	3.00	"	" 2d to 4th, 7th, 10th, 11th	"	"	.116
1423	4, 5, 10	.15	1.50	"	" 1st to 5th	"	Unset
1425	12	.30	3.00	"	" 6th	"	Comp.	.096
1426	13	.15	1.50	"	" 6th	"	Unset
2094	89 to 91, 99, 134	.55	6.50	"	" 8th, 9th	Rosy Ruby	Gold	.116
2275	130, 131	.30	3.00	"	" 8th, 9th	Garnet	Comp.	.116
524	16, 21, 36, 41	1.00	12.00	16	" 1st, 2d, 6th, 7th	Red Ruby	Gold	.144
2276	36, 41	1.00	12.00	"	" 6th, 7th	"	"	.116
2277	41	1.00	12.00	"	" 7th	"	"	.096
1427	32, 37, 98, 102, 126, 126, 132	.55	6.50	"	" 6th to 9th, 13th to 15th, 17th	Rosy Ruby	"	.096
1424	17, 22	.50	5.00	"	" 1st, 2d	"	Comp.	.096
1425	17, 24 to 27, 29 to 31, 33 to 35, 38 to 40	.30	3.00	"	" 1st, 3d to 7th	Garnet	"	.096
1425	92 to 95, 107 to 110, 127	.30	3.00	"	" 6th to 9th	"	"	.096
1426	20, 22, 26, 31	.15	1.50	"	" 1st to 3d, 5th	"	Unset
1424	42	.50	5.00	14	" 1st	Rosy Ruby	Comp.	.096
1425	128, 129	.30	3.00	"	" 2d	Garnet	"	.096
2277	67, 71	1.00	12.00	12	" 2d, 3d	Red Ruby	Gold	.096
1427	68, 72, 135	.55	6.50	"	" 2d to 4th	Rosy Ruby	"	.096
530	44	.50	5.00	"	" 1st	"	Comp.	.096
1425	69, 70, 73, 74, 87, 88	.30	3.00	"	" 2d, 3d	Garnet	"	.096
1425	100, 101, 111 to 114	.30	3.00	"	" 2d	"	"	.096
530	46	.50	5.00	10	" 1st	Rosy Ruby	"	.096
1428	47	.15	1.50	"	" 1st	Garnet	Unset
531	49, 53	.55	6.50	6	" 1st, 2d	Rosy Ruby	Gold	.126
530	50, 54	.50	5.00	"	" 1st	"	Comp.	.096
1425	50, 55, 56, 76, 115	.30	3.00	"	" 1st	Garnet	"	.096
1428	52, 56	.15	1.50	"	" 1st	"	Unset
532	57	.55	6.50	0	" 1st	Rosy Ruby	Gold	.096
2278	76, 77, 80, 81	.55	6.50	"	" 2d, 3d	"	"	.080
1432	58, 77, 81	.50	5.00	"	" 1st to 3d	"	Comp.	.080
1433	59, 60, 78, 82, 84 to 86, 116, 117	.30	3.00	"	" 1st	Garnet	"	.080
1434	60	.15	1.50	"	" 1st	"	Unset
2281	133, 136	.30	3.00	5/0	" 1st, 2d	"	Comp.	.060
2280	96	.55	6.50	10/0	" 1st	Rosy Ruby	Gold	.060
2281	97	.30	3.00	"	" 1st	Garnet	Comp.	.060

JEWELS, ROLLER OR JEWEL PIN

Catalogue No.	Price Per Dozen	Size	Length in Millimeters	Material	Type of Roller used with
559	.60	18 and 16	1.22	Garnet	Single
559L	.60	18 and 16	1.42	Garnet	Single
559D	.60	18 and 16	1.12	Garnet	Double
559C	.60	18 and 16	.97	Garnet	Combination
2075D	2.00	18 and 16	1.12	Sapphire	Double
2075C	2.00	18 and 16	.97	Sapphire	Combination
570	.60	14-12-10-6	1.07	Garnet	Single
570C	.60	14 and 12	.71	Garnet	Combination
2670D	2.00	12	.91	Sapphire	Double
2670C	2.00	12	.71	Sapphire	Combination
571	.60	0	1.07	Garnet	Single
571C	.60	0 and 3/0	.76	Garnet	Combination
2671C	2.00	0 and 3/0	.76	Sapphire	Combination
2150	.60	10/0	.76	Garnet	Single
2150C	.60	5/0 and 10/0	.56	Garnet	Combination

Garnet pins numbers 559—18 and 16 sizes; 570—14, 12, 10 and 6 sizes; 571—0 size and 2150—10/0 size are suitable for use with single rollers. They are furnished in assorted diameters and are the numbers of pins most commonly used.

Garnet pins No. 559 L are longer than No. 559 and are suitable for 18 and 16 size watches made prior to 2,000,000.

Roller jewels used with double roller (table and safety roller separate) and with combination rollers (table and safety roller combined) require shorter pins than single rollers.

D, affixed to a number indicates pins for double roller and C for combination roller.

There is considerable variation in the diameter of jewel pins used in the same grade of movements. In filling orders assorted diameters will be supplied.

We are also prepared to supply pins in separate diameters from 28 to 60 hundredths of a millimeter suitable for assortments.

See pages 132 and 134 for jewel pin assortments.

**JEWELS, THIRD
LOWER**

Catalogue No.	CLASS	PRICE		DESCRIPTION OF MOVEMENT		Settings	
		Piece	Per Doz.	Size	Model	Kind	Diam.
1435	1, 7, 65, 119, 121	.40	4.00	18	F. Pl. 1st to 5th, 7th, 10th, 11th	Pale Ruby	Comp. .116
533	1 to 5, 7 to 10, 66	.30	3.00	"	" 1st to 5th, 7th	Garnet	" .126
2269	4, 5, 9, 10, 61 to 64, 103 to 106	.30	3.00	"	" 1st to 5th	"	" .116
2269	118, 120, 122 to 124	.30	3.00	"	" 2d to 5th, 7th, 10th, 11th	"	" .116
538	12	.30	3.00	"	" 6th	"	" .096
1435	89 to 91, 99, 134	.40	4.00	"	" 8th, 9th	Pale Ruby	" .116
2269	130, 131	.30	3.00	"	"	Garnet	" .116
536	16, 21	.55	6.50	16	" 1st, 2d	Rosy Ruby	Gold .096
1436	17, 22, 32, 36, 37, 41, 98, 126, 127, 132	.40	4.00	"	" 1st, 2d, 4th, 7th, 13th, 16th, 17th	Pale Ruby	Comp. .096
2270	32, 37, 98, 102, 125, 126	.40	4.00	"	" 6th to 9th, 13th, 15th	"	" .088
538	17, 22, 24 to 27, 29 to 31, 33 to 35, 38 to 40, 92 to 95, 107 to 110, 127	.30	3.00	"	" 1st to 7th, 9th	Garnet	" .096
2271	31, 33 to 35, 38 to 40, 92 to 95, 107 to 110, 127	.30	3.00	"	" 5th to 7th, 9th	"	" .088
1436	42	.40	4.00	14	" 1st	Pale Ruby	" .096
2271	128, 129	.30	3.00	"	" 2d	Garnet	" .088
538	128, 129	.30	3.00	"	"	"	" .096
1436	44, 67, 68, 71, 72, 135	.40	4.00	12	" 1st to 4th	Pale Ruby	" .096
2270	68, 72	.40	4.00	"	" 2d, 3d	"	" .088
2271	69, 70, 73, 74, 87, 88	.30	3.00	"	"	Garnet	" .088
2271	100, 101, 111 to 114	.30	3.00	"	"	"	" .088
538	69, 70, 73, 74, 87, 88	.30	3.00	"	"	"	" .096
538	100, 101, 111 to 114	.30	3.00	"	"	"	" .096
1436	46	.40	4.00	10	" 1st	Pale Ruby	" .096
538	47	.30	3.00	"	"	Garnet	" .096
1436	49, 50, 53, 54	.40	4.00	6	" 1st, 2d	Pale Ruby	" .096
538	50, 55, 56, 75, 115	.30	3.00	"	"	Garnet	" .096
2271	56, 75, 115	.30	3.00	"	" 2d	"	" .088
544	57, 58, 76, 77, 80, 81	.40	4.00	0	" 1st to 3d	Pale Ruby	" .080
1439	59, 60, 78, 82, 84 to 86, 116, 117	.30	3.00	"	"	Garnet	" .080
2273	133	.30	3.00	5/0	" 1st	"	" .054
2933	133, 136	.30	3.00	"	" 1st, 2d	"	" .060
2272	96	.40	4.00	10/0	" 1st	Pale Ruby	" .054
2932	96	.40	4.00	"	"	"	" .060
2273	97	.30	3.00	"	"	Garnet	" .054
2933	97	.30	3.00	"	"	"	" .060

**JEWELS, PALLET STONES
RIGHT OR LEFT**

Catalogue No.	Price		Size	Material	Finish	
	Piece	Per Doz.			Sides	Face
546R	.50	6.00	18 and 16	Ruby	Polished	Polished
546S	.45	4.50	18 and 16	Sapphire	"	"
546G	.15	1.50	18 and 16	Garnet	"	"
546G	.10	1.00	18 and 16	Garnet	Gray	"
556S	.45	4.50	12	Sapphire	Polished	"
556G	.15	1.50	14-12-10-6	Garnet	"	"
556G	.10	1.00	14-12-10-6	Garnet	Gray	"
558S	.45	4.50	0	Sapphire	Polished	"
558G	.15	1.50	0	Garnet	"	"
558G	.10	1.00	0	Garnet	Gray	"
2131G	.15	1.50	5/0 and 10/0	Garnet	Polished	"
2131G	.10	1.00	5/0 and 10/0	Garnet	Gray	"

The letters affixed to the numbers of pallet stones indicate the material from which stones are made. G is garnet, R ruby and S sapphire. In ordering specify catalogue number, style (New or Old) and price.

Two thicknesses of garnet pallet stones have been used in the several sizes of watches taking Nos. 546G and 556G. The thin stones are known as New Style and the thick as Old Style. In filling orders, unless Old Style is mentioned, the New Style will be sent.

THICKNESS OF PALLET STONES

In Thousandths of an Inch and Equivalent Thickness in Millimeters

	Inches	Millimeters
18 and 16 Old Style (thick)	.0168	.4267
18 and 16 New Style (thin)	.0148	.3759
6 Old Style (thick)	.0146	.3708
6 New Style (thin)	.0128	.3251

LEVERS, CAM

Catalogue No.	CLASS	PRICE		DESCRIPTION OF MOVEMENT		
		Piece	Per Doz.	Size	Model	
163	12 to 1415	1.50	18	¼ Pl.	6th

No. 163



Htg. or O. F.

LEVERS, CLUTCH

Catalogue No.	CLASS	PRICE		DESCRIPTION OF MOVEMENT		
		Piece	Per Doz.	Size	Model	
1826	80 to 91, 9920	2.00	18	¼ Pl.	8th, 9th
1826	13415	1.50	"	"	8th
1826	130, 13110	1.00	"	"	8th, 9th
1440	36, 4120	2.00	16	"	6th, 7th
1440	32 to 34, 37 to 3915	1.50	"	"	"
1440	35, 4010	1.00	"	"	"
1441	32, 36, 37, 4120	2.00	"	"	"
1441	33, 34, 38, 3915	1.50	"	"	"
1441	35, 40, 92 to 95, 107 to 11010	1.00	"	"	"
2154	98, 13220	2.00	"	"	9th, 13th, 15th
2154	102, 12715	1.50	"	"	"
2545	12620	2.00	"	"	14th
2545	12515	1.50	"	"	8th
2794	12820	2.00	"	"	17th
1827	128, 12910	1.00	14	"	2d
1827	67, 68, 71, 7220	2.00	12	"	2d, 3d
1827	69, 7315	1.50	"	"	"
1827	70, 74, 87, 88, 100, 101, 111 to 11410	1.00	"	"	"
2751	13520	2.00	"	"	4th
1828	76, 8020	2.00	0	"	2d, 3d
1828	77, 8115	1.50	"	"	"
1828	78, 79, 82, 83, 85, 86, 116, 11710	1.00	"	"	"
1829	133, 13610	1.00	5/0	"	1st, 2d
1829	9620	2.00	10/0	"	1st
1829	9710	1.00	"	"	"

No. 1440



Htg. or O. F.

No. 1441



Htg. or O. F.

No. 1826



Htg. or O. F.

No. 1827



Htg. or O. F.

No. 1828



Htg. or O. F.

No. 1829



Htg. or O. F.

No. 2154



O. F.

No. 2545



Htg.

No. 2751



O. F.

No. 2794



Htg.

Read carefully the introduction which explains fully our system of cataloguing.

Orders for less than one-fourth dozen pieces of a kind will be charged at the single piece price.

LEVERS, SETTING

Catalogue No.	CLASS	PRICE		DESCRIPTION OF MOVEMENT		
		Piece	Per Doz.	Size	Model	
* 26	1.....	.30	3.00	18	F. Pl.	2d to 4th
* 26	2 to 5.....	.25	2.50	"	"	"
43	1.....	.30	3.00	"	"	"
43	2 to 5.....	.25	2.50	"	"	"
43	119.....	.20	2.00	"	"	10th
48	4, 5, 118.....	.20	2.00	"	"	2d to 4th, 10th
114	6, 61, 62, 103, 105, 123.....	.20	2.00	"	"	2d to 4th
171	7.....	.20	2.00	"	"	5th
171	8, 9.....	.15	1.50	"	"	"
171	10, 11, 120.....	.10	1.00	"	"	5th, 11th
1830	65.....	.30	3.00	"	"	7th
1830	66.....	.25	2.50	"	"	"
1830	121, 122, 124.....	.20	2.00	"	"	7th, 11th
1742	63, 64.....	.25	2.50	"	"	6th
1743	63, 64, 104, 106.....	.25	2.50	"	"	"
168	12 to 14.....	.15	1.50	"	"	3/4 Pl.
1831	89 to 91, 99.....	.30	3.00	"	"	6th
1831	134.....	.25	2.50	"	"	8th, 9th
1831	130, 131.....	.20	2.00	"	"	8th
1831	130, 131.....	.20	2.00	"	"	8th, 9th
68	15.....	.20	2.00	17	F. Pl.	2d
2155	98, 132.....	.30	3.00	16	3/4 Pl.	9th, 13th, 15th
2155	102, 127.....	.25	2.50	"	"	"
83	16, 21.....	.30	3.00	"	"	1st, 2d
† 83	17 to 20, 22, 23.....	.25	2.50	"	"	"
† 125	24, 25, 27, 28.....	.25	2.50	"	"	3d, 4th
† 125	26.....	.20	2.00	"	"	3d
1442	32, 36, 37, 41.....	.20	2.00	"	"	6th, 7th
1442	33, 34, 38, 39.....	.15	1.50	"	"	"
1442	35, 40.....	.10	1.00	"	"	"
1443	32, 36, 37, 41.....	.20	2.00	"	"	"
1443	33, 34, 38, 39.....	.15	1.50	"	"	"
1443	35, 40, 92 to 95, 107 to 110.....	.10	1.00	"	"	"
573	29, 30.....	.15	1.50	"	"	5th
573	31.....	.10	1.00	"	"	"
2537	126.....	.30	3.00	"	"	14th
2537	125.....	.25	2.50	"	"	8th
2795	126.....	.30	3.00	"	"	17th
1832	128, 129.....	.10	1.00	14	"	2d
1832	67, 68, 71, 72.....	.20	2.00	12	"	2d, 3d
1832	69, 73.....	.15	1.50	"	"	"
1832	70, 74, 87, 88, 100, 101, 111 to 114.....	.10	1.00	"	"	"
2762	135.....	.20	2.00	"	"	4th
† 99	49 to 51.....	.25	2.50	6	"	1st
† 144	52.....	.20	2.00	"	"	"
1444	53 to 55.....	.15	1.50	"	"	2d
1444	56.....	.10	1.00	"	"	"
1445	53 to 55.....	.15	1.50	"	"	"
1445	56.....	.10	1.00	"	"	"
1753	75, 115.....	.10	1.00	"	"	"
575	57 to 59.....	.15	1.50	0	"	1st
575	60.....	.10	1.00	"	"	"
1725	84.....	.10	1.00	"	"	"
1833	76, 80.....	.20	2.00	"	"	2d, 3d
1833	77, 81.....	.15	1.50	"	"	"
1833	78, 79, 82, 83, 85, 86, 116, 117.....	.10	1.00	"	"	"
1834	133, 136.....	.10	1.00	5/0	"	1st, 2d
1834	96.....	.20	2.00	10/0	"	1st
1834	97.....	.10	1.00	"	"	"





























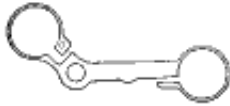

*The first 18 Size Stem-Wind Movements used Setting Lever No. 26.

†Catalogue No. 83 and No. 125 are made both 14 and 16 Size, and No. 99 and No. 144, 6 and 8 size; therefore it is necessary to specify the size, in addition to Catalogue Number and Class; and if not positive as to Size give Number of Movement.

To ascertain Grade and Class of movement refer to numbers in the back of the catalogue under the head of "Number and Grade with classification and description of movements."

Orders for less than one-fourth dozen pieces of a kind will be charged at the single piece price.

LEVERS, SETTING

<p>No. 26</p>  <p>Htg.</p>	<p>No. 43</p>  <p>Htg.</p>	<p>No. 48</p>  <p>Htg.</p>	<p>No. 68</p>  <p>Htg.</p>	
<p>No. 83</p>  <p>Htg. or O. F.</p>	<p>No. 99</p>  <p>Htg.</p>	<p>No. 114</p>  <p>Htg.</p>	<p>No. 125</p>  <p>Htg. or O. F.</p>	
<p>No. 144</p>  <p>Htg.</p>	<p>No. 168</p>  <p>Htg. or O. F.</p>	<p>No. 171</p>  <p>O. F.</p>	<p>No. 573</p>  <p>O. F.</p>	<p>No. 575</p>  <p>Htg.</p>
<p>No. 1442</p>  <p>Htg. or O. F.</p>	<p>No. 1443</p>  <p>Htg. or O. F.</p>	<p>No. 1444</p>  <p>Htg.</p>	<p>No. 1445</p>  <p>Htg.</p>	<p>No. 1725</p>  <p>Htg.</p>
<p>No. 1742</p>  <p>O. F.</p>	<p>No. 1743</p>  <p>O. F.</p>	<p>No. 1753</p>  <p>Htg.</p>	<p>No. 1830</p>  <p>O. F.</p>	
<p>No. 1831</p>  <p>Htg. or O. F.</p>	<p>No. 1832</p>  <p>Htg. or O. F.</p>	<p>No. 1833</p>  <p>Htg. or O. F.</p>	<p>No. 1834</p>  <p>O. F.</p>	<p>No. 2155</p>  <p>O. F.</p>
<p>No. 2537</p>  <p>Htg.</p>	<p>No. 2752</p>  <p>O. F.</p>	<p>No. 2795</p>  <p>Htg.</p>		

NUTS, CENTER PINION

Catalogue No.	CLASS	PRICE		DESCRIPTION OF MOVEMENT		
		Piece	Per Doz.	Size	Model	
8	1 to 5.....	.10	1.00	18	F. Pl.	1st to 4th
576	42, 43.....	.10	1.00	14	3/4 Pl.	1st
578	44, 45.....	.10	1.00	12	"	"
578	46 to 48.....	.10	1.00	10	"	"

NUTS, CENTER WHEEL

Catalogue No.	CLASS	PRICE		DESCRIPTION OF MOVEMENT		
		Piece	Per Doz.	Size	Model	
1835	89 to 91, 99.....	.15	1.50	18	3/4 Pl.	8th, 9th
1836	76 to 78, 80 to 82.....	.15	1.50	9	"	2d, 3d
1836	79, 83.....	.10	1.00	"	"	"

No. 1835



Htg. or O. F.

No. 1836



Htg. or O. F.

NUTS AND SCREWS, PATENT REGULATOR

Catalogue No.	CLASS	PRICE		DESCRIPTION OF MOVEMENT			
		Piece	Per Doz.	Size	Model		
584	1 to 5, 7 to 10, 61 to 66, 105, 106, 122 to 124	.20	2.00	18	F. Pl.	1st to 5th, 7th
587	12.....	.20	2.00	"	3/4 Pl.	6th
1837	89.....	.40	4.00	"	"	8th	Gold
1837	90, 91, 99, 130, 131, 134.....	.20	2.00	"	"	8th, 9th
587	16, 21.....	.40	4.00	16	"	1st, 2d	Gold
587	17, 18, 22.....	.20	2.00	"	"	"
1447	36, 41, 132.....	.40	4.00	"	"	6th, 7th, 15th	Gold
1447	32 to 35, 37 to 40, 92 to 95, 98.....	.20	2.00	"	"	6th to 9th
1447	102, 107 to 110, 125 to 127.....	.20	2.00	"	"	13th to 15th, 17th
1550	128, 129.....	.20	2.00	14	"	2d
1550	67, 71.....	.40	4.00	12	"	2d, 3d	Gold
1550	68 to 70, 72 to 74, 87, 88, 100, 101, 111 to 114	.20	2.00	"	"	"
2753	135.....	.40	4.00	"	"	4th	Gold
2342	53.....	.40	4.00	6	"	2d
1550	53, 54, 56.....	.20	2.00	"	"	"
2343	57, 76, 80.....	.40	4.00	0	"	1st to 3d	Gold
1551	57, 58, 60, 77, 81, 116, 117.....	.20	2.00	"	"	"

No. 584



Htg. or O. F.

No. 587, 1447



Htg. or O. F.

No. 1550, 2342



Htg. or O. F.

No. 1551, 2343



Htg. or O. F.

No. 1837



Htg. or O. F.

No. 2753





O. F.

PALLETS, WITH STONES FITTED

Catalogue No.	CLASS	PRICE		DESCRIPTION OF MOVEMENT		Stones
		Piece	Per Doz.	Size	Model	
2675	1, 65	1.10	13.00	18	P. Pl. 2d to 4th, 7th, 10th, 11th	Sapphire
* 2	119, 121	1.00	12.00	"	" " " " " "	"
* 2	1, 2, 7, 65	.70	8.00	"	" " 1st to 5th, 7th	Garnet
* 2	3, 4, 8, 9, 66, 118, 120, 123, 124	.60	7.00	"	" " 1st to 5th, 7th, 10th, 11th	"
* 2	5, 10, 11, 61, 63, 64, 104, 106, 122	.50	5.50	"	" " 1st to 5th, 7th	"
* 4	3 to 5	.55	6.50	"	" " 1st to 4th	"
* 4	6, 61, 62, 103, 105	.50	5.50	"	" " " "	"
* 2	12	.60	7.00	"	3/4 Pl. 6th	"
†2675	89	1.70	20.00	"	" " 8th	Sapphire
2675	90, 91, 99	1.10	13.00	"	" " 8th, 9th	"
2675	134	1.00	12.00	"	" " 8th	"
2	90, 91, 99	.70	8.00	"	" " 8th, 9th	Garnet
2	130, 131	.60	7.00	"	" " " "	"
*†2674	16, 21, 36, 41	2.00	24.00	16	" " 1st, 2d, 6th, 7th	Ruby
†2675	36, 41, 132	1.70	20.00	"	" " 6th, 7th, 15th	Sapphire
2675	98, 126	1.10	13.00	"	" " 13th to 15th, 17th	"
2675	102, 125	1.00	12.00	"	" " 8th, 13th, 15th	"
* 2	17, 18, 22, 32, 37, 98	.70	8.00	"	" " 1st, 2d, 6th, 7th, 9th	Garnet
* 2	19, 23 to 25, 27 to 30, 33, 34, 38, 39, 102, 107, 108	.60	7.00	"	" " 1st to 7th, 9th	"

*Two different forms of Pallets have been used in these Classes, the difference being the thickness of Jewel or Stone required; those taking thin ones being known as New Style. In filling orders, unless Old Style is mentioned, the New Style will be sent.

†Poised.

No. 2, 2674, 2675  Htg. or O. F.	No. 4  Htg.
---	--

When a Pallet is wanted for a particular Movement, in order to get it well matched, send the Escape Wheel.

THICKNESS OF PALLET STONES

In Thousandths of an Inch and Equivalent Thickness in Millimeters.









Inches	Millimeters
18 and 16 Old Style (thick) .0168	.4267
18 and 16 New Style (thin) .0148	.3759
6 Old Style (thick) .0146	.3708
6 New Style (thin) .0128	.3251

Read the introduction page carefully as it explains fully our system of cataloguing.

To ascertain Grade and Class of movement refer to numbers in the back of the catalogue under the head of "Number and Grade with classification and description of movements." To find where the particular kind of material required is listed, refer to the index which will be found on the last pages of this catalogue.

PALLETS AND FORKS WITH STONES FITTED FOR SINGLE ROLLER

Catalogue No.	CLASS	PRICE		DESCRIPTION OF MOVEMENT		Stones
		Piece	Per Doz.	Size	Model	
* 596	1, 2, 7, 65	.95	10.50	18	F. Pl. 1st to 5th, 7th	Garnet
* 596	3, 4, 8, 9, 86, 118, 120, 123, 124	.75	9.00	"	" 1st to 5th, 7th, 10th, 11th	"
* 596	5, 10, 11, 61, 63, 64, 104, 106, 122	.60	7.00	"	" 1st to 5th, 7th	"
597	3 to 5	.70	8.00	"	" 1st to 4th	"
* 597	6, 61, 62, 103, 105	.55	6.50	"	"	"
596	12	.75	9.00	"	5/4 Pl. 6th	"
603	13, 14	.60	7.00	"	"	"
2078	90, 91, 99	1.15	14.00	"	" 8th, 9th	"
601	15	.60	7.00	17	F. Pl. 1st, 2d	"
* 596	16, 21, 36, 41	2.50	30.00	16	5/4 Pl. 1st, 2d, 6th, 7th	Ruby Garnet
* 596	17, 18, 22, 32, 37, 98	.90	10.50	"	" 1st, 2d, 6th, 7th, 9th	"
* 596	19, 23 to 25, 27 to 30, 33, 34, 38, 39, 102, 107, 108	.75	9.00	"	" 1st to 7th, 9th	"
2078	36, 41	2.50	30.00	"	" 6th, 7th	Ruby Garnet
* 603	20, 26, 31, 35, 40	.90	7.00	"	" 1st, 3d to 5th, 7th	"
2345	31, 93, 95, 109, 110, 127	.60	7.00	"	" 5th to 7th, 9th	"
601	92, 94	.60	7.00	"	" 6th, 7th	"
1839	93, 95	.60	7.00	"	"	"
611	42	.85	10.00	14	" 1st	"
611	43	.75	9.00	"	" 2d	"
2589	128, 129	.60	7.00	"	" 2d, 3d	"
611	44	.85	10.00	12	" 1st	"
611	45	.75	9.00	"	"	"
2060	67, 71	1.75	21.00	"	"	Ruby Sapphire
2070	67, 71	1.45	17.00	"	"	"
2070	68, 72	1.35	16.00	"	"	"
2071	68, 69, 72, 73	.95	11.00	"	"	Garnet
*2071	70, 74, 87, 88, 100, 101, 111 to 114	.60	7.00	"	"	"
1841	87, 88, 100, 101	.60	7.00	"	"	"
2072	67, 71	1.75	21.00	"	"	Ruby Sapphire
2073	67, 71	1.45	17.00	"	"	"
2073	68, 72	1.35	16.00	"	"	"
2589	68, 69, 72, 73	.95	11.00	"	"	Garnet
*2589	70, 74, 87, 88, 100, 101, 111 to 114	.60	7.00	"	"	"
611	46	.85	10.00	10	" 1st	"
611	47, 48	.75	9.00	"	"	"
611	49, 50	.85	10.00	6	"	"
611	51	.75	9.00	"	"	"
613	52	.70	8.00	"	"	"
2071	49, 50, 53, 54	.95	11.00	"	" 1st, 2d	"
2071	51, 55	.80	9.50	"	"	"
*2071	52, 56, 75	.60	7.00	"	" 2d	"
1841	75	.60	7.00	"	" 1st, 2d	"
2589	49, 50, 53, 54	.95	11.00	"	"	"
2589	51, 55	.80	9.50	"	"	"
*2589	52, 56, 75, 115	.60	7.00	"	"	"
2075	57, 58, 76, 77, 80, 81	.95	11.00	6	" 1st to 3d	"
2075	59, 78, 82	.80	9.50	"	"	"
2075	60, 79, 83 to 86, 116, 117	.60	7.00	"	" 2d, 3d	"
2590	76, 77, 80, 81	.95	11.00	"	"	"
2590	78, 82	.80	9.50	"	" 1st to 3d	"
2590	79, 83 to 86, 116, 117	.60	7.00	"	"	"
1726	84 to 86	.60	7.00	"	"	"
1843	96	.85	10.00	10/0	" 1st	"
1843	97	.75	9.00	"	"	"
2976	96	.85	10.00	"	"	"
2976	97	.75	9.00	"	"	"

<p>No. 596</p>  <p>Htg. or O. F.</p>	<p>No. 597</p>  <p>Htg.</p>	<p>No. 601, 603, 1839, 2345</p>  <p>Htg. or O. F.</p>	<p>No. 611</p>  <p>Htg.</p>	<p>No. 613</p>  <p>Htg.</p>
<p>No. 1726, 2590, 2975</p>  <p>Htg. or O. F.</p>	<p>No. 1841, 2589, 2969, 2970, 2971, 2972, 2973</p>  <p>Htg. or O. F.</p>	<p>No. 1843, 2976</p>  <p>O. F.</p>	<p>No. 2078</p>  <p>Htg. or O. F.</p>	

*Two different forms of Pallets have been used in these Classes, the difference being the thickness of Jewel or Stone required; those taking thin ones being known as New Style. In filling orders, unless Old Style is mentioned, the New Style will be sent.

When a Pallet and Fork is wanted for a particular movement, in order to get it well matched, send the Escape Wheel.

**PALLETS AND FORKS WITH STONES FITTED
FOR DOUBLE ROLLER**

Catalogue No.	CLASS	PRICE		DESCRIPTION OF MOVEMENT		Stones	
		Pieces	Per Doz.	Size	Model		
2676	1, 65	1.75	21.00	18	F. Pl.	2d to 4th, 7th	Sapphire
2512	119, 121	1.50	18.00	"	"	10th, 11th	"
2677	124	1.15	13.50	"	"	7th	Garnet
2677	106	1.00	11.50	"	"	5th	"
2676	89	2.40	29.00	"	3/4 Pl.	8th	Sapphire
2676	90, 91, 99	1.75	21.00	"	"	8th, 9th	"
2978	134	1.55	18.50	"	"	8th	"
2677	130, 131	1.15	13.50	"	"	8th, 9th	Garnet
2682	36, 41, 132	2.75	33.00	16	"	6th, 7th, 15th	Ruby
2676	36, 41, 132	2.45	29.00	"	"	6th, 7th, 15th	Sapphire
2676	98, 126	1.75	21.00	"	"	9th, 13th to 15th, 17th	"
2676	102, 125	1.60	19.00	"	"	8th, 9th, 13th, 15th	"
2677	33, 38, 107, 108	1.15	13.50	"	"	6th, 7th	Garnet
2891	109, 110, 127	.70	8.00	"	"	6th, 7th, 9th	"
2865	128, 129	.70	8.00	14	"	2d	"
2678	67, 71	1.85	23.00	12	"	2d, 3d	Ruby
2679	68, 72	1.50	18.00	"	"	"	Sapphire
2865	111 to 114	.70	8.00	"	"	"	Garnet
2974	135	1.60	19.00	"	"	4th	Sapphire
2977	135	1.45	17.00	"	"	"	"
2680	76, 80	1.45	17.00	0	"	2d, 3d	"
2681	76, 77, 80, 81	1.00	12.00	"	"	"	Garnet
2681	78, 82	.90	10.50	"	"	"	"
2681	116, 117	.70	8.00	"	"	"	"
2683	133, 136	.85	10.00	5/0	"	1st, 2d	"
2683	96	1.15	14.00	10/0	"	1st	"
2683	97	.85	10.00	"	"	"	"

No. 2512



Htg. or O. F.

No. 2676, 2677, 2682, 2978



Htg. or O. F.

No. 2678, 2679, 2865, 2974, 2977



Htg. or O. F.

No. 2680, 2681



Htg. or O. F.

No. 2683



Htg. or O. F.

No. 2891



Htg. or O. F.

{Pointed.

It will be observed that in some instances more than one number is applied to the same illustration. The reason for this is that a difference exists which cannot be shown by an illustration. This difference is usually explained in the description following the catalogue number.

Your Jobber will supply Balance Staffs, Balance Jewels, Roller Jewels. Hands and Screws in Dozen lots in original sealed trade marked Packages.



[TOP]

TRADE-MARKED
PACKAGE











[BOTTOM]

PALLETS, FORKS AND ARBORS WITH STONES FITTED FOR SINGLE ROLLER

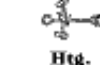
Catalogue No.	CLASS	PRICE		DESCRIPTION OF MOVEMENT		Pivots	Stones
		Piece	Per Doz.	Size	Model		
1449	1, 7, 65	1.30	15.50	18	F. Pl.	2d to 5th, 7th	Garnet
* 615	1, 2, 7, 83	1.10	13.00	"	"	1st to 5th, 7th	"
* 615	3, 4, 8, 9, 66, 118, 120	1.00	11.50	"	"	1st to 5th, 7th, 10th, 11th	"
615	123, 124	.95	11.00	"	"	2d to 4th, 7th	"
615	104, 106, 122	.75	9.00	"	"	5th, 7th	"
* 615	6, 10, 11, 61, 63, 64	.75	8.50	"	"	1st to 5th	"
616	3, 4, 5	.90	10.50	"	"	1st to 4th	"
616	103, 105	.75	8.50	"	"	2d to 4th	"
* 616	6, 61, 62	.70	8.00	"	"	1st to 4th	"
621	12	1.00	11.50	"	3/4 Pl.	6th	"
622	13, 14	.75	8.50	"	"	"	"
2080	90, 99	1.00	19.00	"	"	8th, 9th	"
2095	91	1.40	16.50	"	"	8th	"
620	15	.75	8.50	"	"	1st, 2d	"
*1450	16, 21, 36, 41	2.90	35.00	16	3/4 Pl.	1st, 2d, 6th, 7th	"
1450	98	1.30	15.50	"	"	9th	"
2348	36, 41	2.90	35.00	"	"	6th, 7th	"
* 621	17, 18, 22, 32, 37	1.10	13.00	"	"	1st, 2d, 6th, 7th	"
* 621	19, 23 to 25, 27 to 30, 33, 34, 38, 39, 102, 107, 108	1.00	11.50	"	"	1st to 7th, 9th	"
* 622	20, 26, 31, 35, 40, 92 to 95, 109, 110, 137	.75	9.00	"	"	1st, 3d, 5th to 7th, 9th	"
630	42	1.05	12.50	14	"	1st	"
630	43	1.00	11.50	"	"	"	"
2595	128, 129	.75	8.50	"	"	2d	"
630	44	1.05	12.50	12	"	1st	"
630	45	1.00	11.50	"	"	"	"
2983	67, 71	2.20	26.00	"	"	2d, 3d	"
2984	67, 71	1.85	22.00	"	"	"	"
2984	68, 72	1.75	21.00	"	"	"	"
2985	68, 69, 72, 73	1.10	13.00	"	"	"	"
2985	70, 74, 87, 88, 100, 101, 111 to 114	.75	9.00	"	"	"	"
630	46	1.05	12.50	10	"	"	"
630	47, 48	1.00	11.50	"	"	"	"
631	49, 50	1.05	12.50	6	"	"	"
631	51	.95	11.00	"	"	"	"
632	52	.80	9.50	"	"	"	"
2731	49, 50, 53, 54	1.15	13.50	"	"	1st, 2d	"
2731	51, 55	1.00	11.50	"	"	"	"
*2731	52, 56, 75, 115	.75	8.50	"	"	"	"
2986	57, 58	1.15	13.50	9	"	1st	"
2986	59	1.00	11.50	"	"	"	"
2986	60	.75	8.50	"	"	"	"
2596	76, 77, 80, 81	1.15	13.50	"	"	2d, 3d	"
2596	78, 82	.95	11.00	"	"	"	"
2596	116, 117	.75	9.00	"	"	"	"
2596	79, 83 to 86	.75	8.50	"	"	"	"
1848	96	1.10	13.00	10/0	"	1st	"
1848	97	1.00	12.00	"	"	"	"

* Two different forms of Pallets have been used in these Classes, the difference being the thickness of Jewel or Stone required; those taking thin ones being known as New Style. In filling orders, unless Old Style is mentioned, the New Style will be sent.

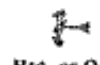
No. 615, 621, 1449, 1450  Htg. or O. F.	No. 616  Htg.	No. 620  Htg.	No. 622  Htg. or O. F.	No. 630, 631  Htg.
No. 632  Htg.	No. 1848  O. F.	No. 2080, 2095, 2348  Htg. or O. F.	No. 2595, 2731, 2983, 2984, 2985  Htg. or O. F.	No. 2596, 2986  Htg. or O. F.

THICKNESS OF PALLET STONES

In Thousandths of an Inch and Equivalent Thickness in Millimeters.

	Inches	Millimeters
18 and 16 Old Style (thick)	.0168	.4267
18 and 16 New Style (thin)	.0148	.3759
6 Old Style (thick)	.0146	.3708
6 New Style (thin)	.0128	.3251

PALLETS, FORKS AND ARBORS WITH STONES FITTED FOR DOUBLE ROLLER

Catalogue No.	CLASS	PRICE		DESCRIPTION OF MOVEMENT		Pivots	Stones	
		Piece	Per Doz.	Size	Model			
2895	106	1.40	16.50	18	F. Pl.	5th	Straight	Garnet
2767	124	1.35	16.00	"	"	7th	"	"
2897	106	1.15	13.50	"	"	5th	"	"
2373	1, 65	2.15	26.00	"	"	2d to 4th, 7th	Cone	Sapphire
2876	1, 65	1.95	23.50	"	"	"	"	"
2514	119, 121	1.90	23.00	"	"	10th, 11th	Cone	"
2513	119, 121	1.75	20.50	"	"	"	Straight	"
†2079	89	2.85	34.00	"	3/4 Pl.	8th	Cone	"
2684	90, 91, 99	2.15	26.00	"	"	8th, 9th	"	"
2685	91	1.95	23.50	"	"	8th	Straight	"
2591	130, 131	1.35	16.00	"	"	8th, 9th	"	Garnet
2757	134	1.90	23.00	"	"	8th	Cone	Sapphire
2896	134	1.75	20.50	"	"	"	Straight	"
2884	109, 110, 127	.85	10.00	16	"	6th, 7th, 9th	"	Garnet
†2594	36, 41, 132	3.15	38.00	"	"	6th, 7th, 15th	Cone	Ruby
†2593	36, 41, 132	2.85	34.00	"	"	"	"	Sapphire
2593	98, 128	2.15	26.00	"	"	9th, 13th to 15th, 17th	"	"
2686	36, 41	2.90	35.00	"	"	6th, 7th	"	Ruby
2898	33, 38, 107, 108	1.30	15.50	"	"	"	Straight	Garnet
2592	98, 126	1.95	23.50	"	"	14th, 15th, 17th	"	Sapphire
2592	102, 125	1.80	21.50	"	"	8th, 9th, 13th, 15th	"	"
2667	98	1.95	23.50	"	"	15th	Cone	"
2803	128, 129	.85	10.00	14	"	2d	Straight	Garnet
2687	67, 71, 135	2.35	28.00	12	"	2d to 4th	Cone	Ruby
2965	67, 71, 135	2.00	24.00	"	"	"	"	Sapphire
2688	68, 72	1.60	19.00	"	"	2d, 3d	Straight	"
2803	111 to 114	.85	10.00	"	"	"	"	Garnet
2758	135	1.60	19.00	"	"	4th	"	Sapphire
2966	76, 80	1.65	19.50	0	"	2d, 3d	"	"
2968	76, 77, 80, 81	1.15	14.00	"	"	"	"	Garnet
2690	116, 117	.85	10.00	"	"	"	"	"
2691	133, 136	1.10	13.00	5/0	"	1st, 2d	"	"
2691	96	1.45	17.00	10/0	"	1st	"	"
2691	97	1.10	13.00	"	"	"	"	"

† Poised.

When a Pallet and Fork or Pallet Fork and Arbor is wanted for a particular movement, in order to get it well matched send the Escape Wheel and Pinion.

No. 2079, 2591, 2592, 2593, 2894, 2684, 2685, 2686, 2757, 2896, 2898, 2967



Htg. or O. F.

No. 2513, 2514



Htg. or O. F.

No. 2573, 2767, 2876, 2895, 2897



Htg. or O. F.

No. 2687, 2688, 2758, 2803, 2965



Htg. or O. F.

No. 2690, 2966, 2968



Htg. or O. F.

No. 2691



Htg. or O. F.

No. 2884



Htg. or O. F.

It will be observed that in some instances more than one number is applied to the same illustration. The reason for this is that a difference exists which cannot be shown by an illustration. This difference is usually explained in the description following the catalogue number.

























Read the introduction page carefully as it explains fully our system of cataloguing.

PINIONS, BEVEL

Catalogue No.	CLASS	PRICE		DESCRIPTION OF MOVEMENT			Teeth
		Piece	Per Doz.	Size	Model		
27	1 to 5	25	2.50	18	F. Pl.	2d to 4th	14
* 49	1 to 5	25	2.50	"	"	"	14
* 49	6	20	2.00	"	"	"	14
*1452	1 to 4	25	2.50	"	"	"	14
*1452	5, 6	20	2.00	"	"	"	14
1849	1, 4, 118, 119	25	2.50	"	"	2d to 4th, 10th	14
1849	5	20	2.00	"	"	2d to 4th	14
1739	61, 62, 103, 105, 123	20	2.00	"	"	"	14
178	7 to 9, 65, 68, 120 to 122	25	2.50	"	"	5th, 7th, 11th	14
178	10, 11, 124	20	2.00	"	"	5th, 7th	14
1738	63, 64, 104, 106	20	2.00	"	"	5th	14
167	12 to 14	25	2.50	"	3/4 Pl.	6th	22
1850	89 to 91, 99	30	3.00	"	"	8th, 9th	16
1850	130, 131, 134	25	2.50	"	"	"	15
70	15	25	2.50	17	F. Pl.	2d	14
* 84	16 to 20, 21 to 23	25	2.50	16	3/4 Pl.	1st, 2d	22
*1453	16, 17, 21 to 23	25	2.50	"	"	"	22
* 126	24, 25, 27, 28	25	2.50	"	"	3d, 4th	16
126	29	20	2.00	"	"	3d	16
*1454	24, 25	25	2.50	"	"	"	16
*1454	26	20	2.00	"	"	"	16
*1851	32 to 34, 36 to 39, 41, 98, 102	30	3.00	"	"	6th, 7th, 9th	13
*1851	35, 40, 93, 95, 107, 108, 125 to 127, 132	30	3.00	"	"	6th, 7th, 13th to 15th, 17th	13
†1851	92, 94, 109, 110	25	2.50	"	"	6th, 7th	13
†1455	32 to 34, 36 to 39, 41	30	3.00	"	"	"	13
†1455	35, 40	25	2.50	"	"	"	13
638	29, 30	25	2.50	"	"	5th	16
638	31	20	2.00	"	"	"	16
1852	128, 129	25	2.50	14	"	2d	14
1852	67 to 74	30	3.00	12	"	2d, 3d	14
1852	87, 88, 100, 101, 111 to 114	25	2.50	"	"	"	14
2759	135	30	3.00	"	"	4th	13
* 100	49 to 51	25	2.50	6	"	1st	13
* 100	52	20	2.00	"	"	"	13
*1456	49 to 51	25	2.50	"	"	"	13
*1456	52	20	2.00	"	"	"	13
1353	53 to 55	25	2.50	"	"	2d	13
1353	56	20	2.00	"	"	"	13
1752	75, 115	20	2.00	"	"	"	13
641	57 to 59	35	2.50	0	"	1st	14
641	60	20	2.00	"	"	"	14
1728	84	20	2.00	"	"	"	14
1853	76 to 83	30	3.00	"	"	2d, 3d	15
1853	85, 86, 116, 117	20	2.00	"	"	"	15
1854	133, 136	25	2.50	5/0	"	1st, 2d	12
1854	96	30	3.00	10/0	"	1st	12
1854	97	25	2.50	"	"	"	12

*Two different forms of Bevel Pinions have been used in these Classes, and pains should be taken to compare part wanted with Illustrations before ordering.
 †The difference between 1851 and 1455 is in the size of the hole, the 1455 having the smaller hole.

Among the Movements Classed as 16 Size, First Model, several have been made 14 Size; and of the 6 Size, First Model, several have been made 8 Size; therefore in ordering Bevel Pinions for these Models be particular to state Size in addition to Catalogue Number and Class.























No. 27, 1739  Htg.	No. 49  Htg.	No. 70  Htg.	No. 84  Htg. or O. F.	No. 100  Htg.	No. 126  Htg. or O. F.
No. 167  Htg. or O. F.	No. 178, 1849  Htg. or O. F.	No. 638  O. F.	No. 641  Htg.	No. 1353  Htg.	No. 1452  Htg.
No. 1453  Htg. or O. F.	No. 1454  Htg.	No. 1455, 1851  Htg. or O. F.	No. 1456  Htg.	No. 1728  O. F.	No. 1738  Htg.
No. 1752  Htg.	No. 1850  Htg. or O. F.	No. 1852  Htg. or O. F.	No. 1853  Htg. or O. F.	No. 1854  O. F.	No. 2759  O. F.

PINIONS, CANNON

Catalogue No.	CLASS	PRICE		Size	DESCRIPTION OF MOVEMENT	No. OF TEETH	
		Piece	Per Doz.			Wheel	Pinion
16	1 to 4	.20	2.00	18	F. Pl.	1st	14
16	5, 6, 61	.15	1.50	"	"	"	14
28	1 to 5, 119	.35	3.50	"	"	2d to 4th, 10th	52
50	4, 5, 118, 123	.30	3.00	"	"	"	17
50	6, 61, 62, 103, 105	.25	2.50	"	"	2d to 4th	17
180	7 to 9, 65, 66, 120, 121, 124	.20	2.00	"	"	5th, 7th, 11th	12
180	10, 11, 63, 64, 104, 106, 122	.15	1.50	"	"	5th, 7th	12
166	12 to 14	.20	2.00	"	3/4 Pl.	6th	12
1855	89 to 91, 99, 134	.20	2.00	"	"	8th, 9th	12
1855	130, 131	.15	1.50	"	"	"	12
642	15	.15	1.50	17	F. Pl.	1st	14
16	15	.15	1.50	"	"	"	14
71	15	.30	3.00	"	"	2d	21
127	24, 25	.30	3.00	16	3/4 Pl.	3d	16
127	26	.25	2.50	"	"	"	16
647	27, 28	.30	3.00	"	"	4th	16
649	16 to 23	.15	1.50	"	"	1st, 2d	12
1457	36, 41	.25	2.50	"	"	6th, 7th	12
1457	32 to 34, 37 to 39, 98, 102, 125, 126, 132	.20	2.00	"	"	6th to 9th, 13th to 15th, 17th	12
1457	35, 40, 92 to 95, 107 to 110, 127	.15	1.50	"	"	6th, 7th, 9th	12
646	29, 30	.20	2.00	"	"	5th	12
646	31	.15	1.50	"	"	"	12
649	42, 43	.15	1.50	14	"	1st	12
2597	128, 129	.15	1.50	"	"	2d	12
649	44, 45	.15	1.50	12	"	1st	12
1856	67 to 69, 71 to 73	.20	2.00	"	"	2d, 3d	12
1856	70, 74, 87, 88, 100, 101, 111 to 114	.15	1.50	"	"	"	12
2760	135	.25	2.50	"	"	4th	12
649	46 to 48	.15	1.50	10	"	1st	12
101	49 to 51	.20	2.00	6	"	"	12
101	52	.15	1.50	"	"	"	12
1458	53 to 55	.20	2.00	"	"	2d	12
1458	56, 75, 116	.15	1.50	"	"	"	12
650	57 to 59, 76, 77, 80, 81	.20	2.00	0	"	1st to 3d	10
650	60, 78, 79, 82 to 86, 116, 117	.15	1.50	"	"	"	10
*2934	81, 116, 117	.15	1.50	"	"	2d, 3d	10
2935	116, 117	.15	1.50	3.0	"	"	10
†1857	133, 136	.20	2.00	5.0	"	1st, 2d	10
†2912	133, 136	.20	2.00	"	"	"	10
†1857	96, 97	.20	2.00	10.0	"	1st	10
†2912	96, 97	.20	2.00	"	"	"	10

†No. 2912 Cannon pinions are shorter than 1857. It is desirable therefore in ordering 5/0 and 10/0 Cannon pinions that the old pinion be sent in so that its length may be determined.























*Used in 0 size watches spread to 12 size.

No. 16  Htg.	No. 28  Htg.	No. 50  Htg.	No. 71  Htg.	No. 101  Htg.	No. 127  Htg.
No. 166  Htg. or O. F.	No. 180  O. F.	No. 642  Htg.	No. 646  O. F.	No. 647  Htg. or O. F.	No. 649  Htg. or O. F.
No. 650  Htg. or O. F.	No. 1457  Htg. or O. F.	No. 1458  Htg.	No. 1855  Htg. or O. F.	No. 1856  Htg. or O. F.	No. 1857  O. F.
No. 2597  O. F.	No. 2760  O. F.	No. 2912  Htg. or O. F.	No. 2934  Htg. or O. F.	No. 2935  Htg. or O. F.	

PINIONS, CENTER















Catalogue No.	CLASS	PRICE		DESCRIPTION OF MOVEMENT		Train		Teeth
		Piece	Per Doz.	Size	Model			
9	5	.35	3.50	18	F. Pl. 1st	Slow	Solid	10
954	5, 6	.35	3.50	"	" 2d to 4th	"	"	10
*15	3 to 5	.20	2.00	"	" 1st to 4th	"	Old Style	10
*651	1, 2	.20	2.00	"	"	Quick	"	11
652	1 to 11, 61 to 66, 103 to 106, 118 to 124	.15	1.50	"	" 1st to 5th, 7th, 10th, 11th	"	New Style	12
660	12 to 14	.15	1.50	"	" 6th	"	"	12
1858	89 to 91, 99	.45	4.50	"	" 8th, 9th	"	Solid	12
2598	130, 131, 134	.15	1.50	"	"	"	"	12
72	15	.35	3.50	17	F. Pl. 1st	Slow	Hollow	10
658	16	.35	3.50	"	" 2d	"	Solid	10
73	15	.35	3.50	"	" 1st	Quick	"	12
661	20	.35	3.50	16	3/4 Pl. 1st	"	"	12
664	26	.35	3.50	"	" 3d	"	"	12
666	27, 28	.15	1.50	"	" 4th	"	New Style	12
660	16 to 26, 29 to 41, 92 to 95	.15	1.50	"	" 1st to 3d, 5th to 7th	"	"	12
660	98, 102, 107 to 110, 125, 127	.15	1.50	"	" 6th to 9th, 13th, 15th	"	"	12
2599	41, 98, 102, 126, 132	.15	1.50	"	" 7th, 13th to 15th, 17th	"	"	12
*667	42, 43	.20	2.00	14	" 1st	"	Old Style	12
2600	128, 129	.15	1.50	"	" 2d	"	"	12
*668	44, 45	.20	2.00	12	" 1st	"	Old Style	12
1860	70, 74	.35	3.50	"	" 2d, 3d	"	Solid	12
1859	67 to 74	.15	1.50	"	"	"	New Style	12
1717	87, 88, 100, 101, 111 to 114	.15	1.50	"	"	"	"	12
2761	135	.15	1.50	"	" 4th	"	"	12
*668	46 to 48	.20	2.00	10	" 1st	"	Old Style	12
669	47, 48	.15	1.50	"	"	"	New Style	12
670	49 to 56, 75, 115	.15	1.50	6	" 1st, 2d	"	"	12
1861	76, 77, 80, 81	.35	3.50	0	" 2d, 3d	"	Solid	11
1861	78, 79, 82, 83	.30	3.00	"	"	"	"	11
1862	79, 83, 85, 86	.30	3.00	"	"	"	"	11
671	57 to 60, 84	.15	1.50	"	" 1st	"	New Style	12
2055	77, 81, 85, 86, 116, 117	.15	1.50	"	" 2d, 3d	"	"	12
1863	133	.35	3.50	5/0	" 1st	"	Solid	10
2955	133, 136	.15	1.50	"	" 1st, 2d	"	New Style	11
1863	96, 97	.35	3.50	10/0	" 1st	"	Solid	10
2956	96, 97	.35	3.50	"	"	"	"	10

*Old Style Center Pinions are held in position by a Center Pinion Nut.

No. 9  Htg.	No. 15  Htg.	No. 72  Htg.	No. 73  Htg.	No. 651  Htg.
No. 652, 2598  Htg. or O. F.	No. 654  Htg.	No. 658  Htg.	No. 660, 666, 667, 2599  Htg. or O. F.	No. 661  Htg. or O. F.
No. 664  Htg.	No. 668  Htg.	No. 669  Htg.	No. 670  Htg.	No. 671  Htg.
No. 1717, 1859, 2600, 2761  Htg. or O. F.	No. 1858  Htg. or O. F.	No. 1860  Htg. or O. F.	No. 1861  Htg. or O. F.	No. 1862  Htg. or O. F.
	No. 1863, 2956  O. F.	No. 2055  Htg. or O. F.	No. 2955  O. F.	

PINIONS, ESCAPE

Catalogue No.	CLASS	PRICE		DESCRIPTION OF MOVEMENT		Train	Pivots	Teeth	
		Per Doz.	Per Doz.	Size	Model				
1459	1, 7, 65, 106, 119, 121	.50	6.00	18	F. PL	2d to 5th, 7th, 10th, 11th	Quick	Cone	8
672	1 to 4, 7 to 9, 65, 66, 118 to 121	.35	3.50	"	"	1st to 5th, 7th, 10th, 11th	"	Straight	8
672	103 to 106, 122 to 124	.25	2.50	"	"	2d to 5th, 7th	"	"	8
672	5, 6, 10, 11, 61 to 64	.20	2.00	"	"	1st to 5th	"	"	8
673	3 to 5	.35	3.50	"	"	1st to 4th	Slow	"	7
673	6	.20	2.00	"	"	"	"	"	7
677	12 to 14	.35	3.50	"	3/4 PL	6th	Quick	"	8
1864	89, 90, 91, 99, 134	.50	6.00	"	"	8th, 9th	"	Cone	8
1865	91, 130, 131, 134	.40	4.00	"	"	"	"	Straight	8
676	15	.20	2.00	17	F. PL	1st, 2d	Slow	"	7
1460	16, 21	.50	6.00	16	3/4 PL	"	Quick	Cone	8
1462	36, 41, 98, 126, 132	.50	6.00	"	"	6th, 7th, 9th, 13th to 15th, 17th	"	"	8
677	17 to 19, 22 to 25, 27 to 30	.35	3.50	"	"	1st to 5th	"	Straight	8
677	20, 26, 31	.20	2.00	"	"	1st, 3d, 5th	"	"	8
1461	32 to 34, 37 to 39, 102, 125, 126	.35	3.50	"	"	6th to 8th, 13th to 15th, 17th	"	"	8
1461	107 to 110, 127	.25	2.50	"	"	6th, 7th, 9th	"	"	8
1461	31, 35, 40, 92 to 95	.20	2.00	"	"	5th to 7th	"	"	8
683	42, 43	.35	3.50	14	"	1st	"	"	8
1867	128, 129	.25	2.50	"	"	2d	"	"	8
683	44, 45	.35	3.50	12	"	1st	"	"	8
1866	67, 68, 71, 72	.50	6.00	"	"	2d, 3d	"	Cone	8
1867	68, 69, 72, 73, 111, 112	.35	3.50	"	"	"	"	Straight	8
1867	113, 114	.25	2.50	"	"	"	"	"	8
1867	70, 74, 87, 88, 100, 101	.20	2.00	"	"	"	"	"	8
2867	135	.50	6.00	"	"	4th	"	Cone	8
2762	135	.40	4.00	"	"	"	"	"	8
683	46 to 48	.35	3.50	10	"	1st	"	Straight	8
684	49 to 51, 53 to 55	.35	3.50	6	"	1st, 2d	"	"	8
684	115	.25	2.50	"	"	2d	"	"	8
684	52, 56, 75	.20	2.00	"	"	1st, 2d	"	"	8
685	57 to 59	.35	3.50	0	"	1st	"	"	7
685	60, 84	.20	2.00	"	"	"	"	"	7
1868	76, 77, 80, 81	.35	3.50	"	"	2d, 3d	"	"	7
1868	116, 117	.25	2.50	"	"	"	"	"	7
1868	78, 79, 82, 83, 85, 86	.20	2.00	"	"	"	"	"	7
1869	133, 136	.35	3.50	5/0	"	1st, 2d	"	"	7
1869	96, 97	.35	3.50	10/0	"	1st	"	"	7

No. 672, 673, 1459  Htg. or O. F.	No. 676  Htg.	No. 677  Htg. or O. F.	No. 683  Htg.	No. 684  Htg.
No. 685, 1868  Htg. or O. F.	No. 1460  Htg. or O. F.	No. 1461, 1462  Htg. or O. F.	No. 1864, 1865  Htg. or O. F.	No. 1866  Htg. or O. F.
No. 1867  Htg. or O. F.	No. 1869  Htg. or O. F.	No. 2762  O. F.	No. 2867  O. F.	

Your Jobber will supply Balance Staffs, Balance Jewels, Roller Jewels. Hands and Screws in Dozen lots in original Sealed Trade Marked packages.



[TOP]



















TRADE-MARKED PACKAGE



[BOTTOM]

















PINIONS, FOURTH

Catalogue No.	CLASS	PRICE		DESCRIPTION OF MOVEMENT		Train	Teeth
		Piece	Per Doz.	Size	Model		
7	1 to 4, 118, 119	.35	3.50	18	F. Pl. 1st to 4th, 10th	Quick	10
7	103, 105, 123	.25	2.50	"	" 2d to 4th	"	10
7	5, 6, 61, 62	.20	2.00	"	" 1st to 4th	"	10
686	3 to 5	.35	3.50	"	" "	Slow	8
686	6	.20	2.00	"	" "	"	8
182	7 to 9, 65, 66, 120, 121	.35	3.50	"	" 5th, 7th, 11th	Quick	10
182	104, 106, 122, 124	.25	2.50	"	" 5th, 7th	"	10
182	10, 11, 63, 64	.20	2.00	"	" 5th	"	10
170	12 to 14	.35	3.50	"	$\frac{3}{4}$ Pl. 6th	"	10
1870	89 to 91, 131, 134	.45	4.50	"	" 8th	"	10
2125	99	.45	4.50	"	" 9th	"	10
2125	130	.35	3.50	"	" "	"	10
687	15	.20	2.00	17	F. Pl. 1st, 2d	Slow	8
688	16 to 20, 21 to 25	.35	3.50	16	$\frac{3}{4}$ Pl. 1st to 3d	Quick	10
692	27, 28	.35	3.50	"	" 4th	"	10
659	36	.45	4.50	"	" 6th	"	10
659	32 to 34, 125, 126	.35	3.50	"	" 6th, 8th, 14th, 17th	"	10
659	107, 109	.25	2.50	"	" 6th	"	10
659	26, 35, 92, 93	.20	2.00	"	" 3d, 6th	"	10
691	41, 132	.45	4.50	"	" 7th, 15th	"	10
691	29, 30, 37 to 39, 98, 102	.35	3.50	"	" 5th, 7th, 9th, 13th, 15th	"	10
691	108, 110, 127	.25	2.50	"	" 7th, 9th	"	10
691	31, 40, 94, 95	.20	2.00	"	" 5th, 7th	"	10
694	42, 43	.35	3.50	14	" 1st	"	10
1872	128, 129	.25	2.50	"	" 2d	"	10
694	44, 45	.35	3.50	12	" 1st	"	10
1871	67	.45	4.50	"	" 2d	"	10
1871	68, 69	.35	3.50	"	" "	"	10
1871	111, 113	.25	2.50	"	" "	"	10
1871	70, 87, 100	.20	2.00	"	" "	"	10
1872	71	.45	4.50	"	" 2d	"	10
1872	72, 73	.35	3.50	"	" "	"	10
1872	112, 114	.25	2.50	"	" "	"	10
1872	74, 88, 101	.20	2.00	"	" "	"	10
2796	135	.45	4.50	"	" 4th	"	10
694	46 to 48	.35	3.50	10	" 1st	"	10
695	49 to 51, 53 to 55	.35	3.50	6	" 1st, 2d	"	10
695	118	.25	2.50	"	" 2d	"	10
695	52, 56, 75	.20	2.00	"	" 1st, 2d	"	10
696	57 to 59	.35	3.50	0	" 1st	"	10
696	60, 84	.20	2.00	"	" "	"	10
1873	76, 77	.35	3.50	"	" 2d	"	10
1873	116	.25	2.50	"	" "	"	10
1873	78, 79, 85	.20	2.00	"	" "	"	10
1874	80, 81	.35	3.50	"	" 3d	"	10
1874	117	.25	2.50	"	" "	"	10
1874	82, 83, 86	.20	2.00	"	" "	"	10
1875	133, 136	.35	3.50	5/0	" 1st, 2d	"	8
2109	133, 136	.25	2.50	"	" "	"	8
1875	96, 97	.45	4.50	10/0	" 1st	"	8
2109	96, 97	.45	4.50	"	" "	"	8

No. 7, 686  Htg.	No. 170  Htg. or O. F.	No. 182  O. F.	No. 659  Htg.	No. 687  Htg.
No. 688  Htg. or O. F.	No. 691  O. F.	No. 692  Htg. or O. F.	No. 694  Htg.	No. 695  Htg.
No. 696, 1873  Htg.	No. 1870  O. F.	No. 1871  Htg.	No. 1872  O. F.	No. 1874  O. F.
No. 1875  Htg. or O. F.	No. 2109  Htg. or O. F.	No. 2125  Htg.	No. 2796  O. F.	

PINIONS, THIRD

Catalogue No.	CLASS	PRICE		DESCRIPTION OF MOVEMENT		Train	Teeth
		Piece	Per Doz.	Size	Model		
6	1 to 4, 118, 119.....	.35	3.50	18	F. Pl. 1st to 4th, 10th	Quick	10
6	103, 105, 123.....	.25	2.50	"	" 2d to 4th	"	10
6	5, 6, 61, 62.....	.20	2.00	"	" 1st to 4th	"	10
697	3 to 5.....	.35	3.50	"	" "	Slow	8
697	6.....	.20	2.00	"	" "	"	8
1876	7 to 9, 65, 66, 120, 121.....	.35	3.50	"	" 5th, 7th, 11th	Quick	10
1876	104, 106, 122, 124.....	.25	2.50	"	" 5th, 7th	"	10
1876	10, 11, 63, 64.....	.20	2.00	"	" 5th	"	10
700	12 to 14.....	.35	3.50	"	" 6th	"	10
1877	89, 90, 91, 130, 131, 134.....	.45	4.50	"	3/4 Pl. 8th, 9th	"	10
2126	99, 130.....	.35	3.50	"	" 9th	"	10
699	15.....	.20	2.00	17	F. Pl. 1st, 2d	Slow	8
700	36.....	.45	4.50	16	5/4 Pl. 0th	Quick	10
700	16 to 19, 21 to 25, 32 to 34, 125, 126.....	.35	3.50	"	" 1st to 3d, 6th, 8th, 14th, 17th	"	10
700	107, 109.....	.25	2.50	"	" 6th	"	10
700	20, 26, 35, 92, 93.....	.20	2.00	"	" 1st, 3d, 6th	"	10
704	27, 28.....	.35	3.50	"	" 4th	"	10
703	41, 132.....	.45	4.50	"	" 7th, 15th	"	10
703	29, 30, 37 to 39, 98, 102.....	.35	3.50	"	" 5th, 7th, 9th, 13th, 15th	"	10
703	108, 110, 127.....	.25	2.50	"	" 7th, 9th	"	10
703	31, 40, 94, 95.....	.20	2.00	"	" 5th, 7th	"	10
706	42, 43.....	.35	3.50	14	" 1st	"	10
1878	128, 129.....	.25	2.50	"	" 2d	"	10
706	44, 45.....	.35	3.50	12	" 1st	"	10
1878	67.....	.45	4.50	"	" 2d	"	10
1878	68, 69, 72, 73.....	.35	3.50	"	" 2d, 3d	"	10
1878	111 to 114.....	.25	2.50	"	" "	"	10
1878	70, 74, 87, 88, 100, 101.....	.20	2.00	"	" 3d	"	10
1879	71.....	.45	4.50	"	" 4th	"	10
2763	135.....	.45	4.50	10	" 1st	"	10
706	46 to 48.....	.35	3.50	6	" "	"	10
707	49 to 51.....	.35	3.50	"	" "	"	10
707	52.....	.20	2.00	"	" "	"	10
1463	53 to 55.....	.35	3.50	"	" 2d	"	10
1463	115.....	.25	2.50	"	" "	"	10
1463	56, 75.....	.20	2.00	"	" "	"	10
708	57 to 59.....	.35	3.50	9	" 1st	"	10
708	60, 84.....	.20	2.00	"	" "	"	10
1880	76, 77, 80, 81.....	.35	3.50	"	" 2d, 3d	"	10
1880	116, 117.....	.25	2.50	"	" "	"	10
1880	78, 79, 82, 83, 85, 86.....	.20	2.00	"	" "	"	10
1881	133, 136.....	.35	3.50	5/0	" 1st, 2d	"	8
1881	96.....	.45	4.50	10/0	" 1st	"	8
1881	97.....	.35	3.50	"	" "	"	8

No. 6, 697  Htg.	No. 699  Htg.	No. 700  Htg. or O. F.	No. 703  O. F.	No. 704  Htg. or O. F.
No. 706  Htg.	No. 707  Htg.	No. 708  Htg.	No. 1463  Htg.	No. 1876  O. F.
No. 1877  O. F.	No. 1878  Htg. O. F.	No. 1879  O. F.	No. 1880  Htg. or O. F.	No. 1881  O. F.
No. 2126  Htg.		No. 2763  O. F.		

PINIONS, SWEEP SECOND

Catalogue No.	CLASS	PRICE		DESCRIPTION OF MOVEMENT		Teeth
		Piece	Per Doz.	Size	Model	
700	27, 28.....	.20	2.00	16	¼ Pl. 4th	12

No. 709



Htg. or O. F.

PINS, BEVEL PINION

Catalogue No.	CLASS	PRICE		DESCRIPTION OF MOVEMENT	
		Piece	Per Doz.	Size	Model
179	7 to 11, 120.....	.10	.75	18	F. Pl. 5th, 11th
1744	63, 64, 104, 106.....	.10	.75	"	" 5th
165	12 to 14.....	.10	.75	"	¼ Pl. 6th
710	29 to 31.....	.10	.75	16	" 5th
1464	32 to 41.....	.10	.75	"	" 6th, 7th
1465	53 to 56.....	.10	.75	6	" 2d
1754	75, 115.....	.10	.75	"	" "
711	57 to 80, 84.....	.10	.75	0	" 1st

No. 165



Htg. or O. F.

No. 179



O. F.

No. 710



O. F.

No. 711



Htg.

No. 1464



Htg. or O. F.

No. 1465



Htg.

No. 1744



O. F.

No. 1754



Htg.

PINS, SETTING

Catalogue No.	CLASS	PRICE		DESCRIPTION OF MOVEMENT	
		Piece	Per Doz.	Size	Model
86	12 to 14.....	.10	.75	18	¼ Pl. 6th
86	16 to 23.....	.10	.75	16	" 1st, 2d

No. 86



Htg. or O. F.

PIVOTS, BEVEL PINION

Catalogue No.	CLASS	PRICE		DESCRIPTION OF MOVEMENT	
		Piece	Per Doz.	Size	Model
29	1 to 5.....	.10	.75	18	F. Pl. 2d to 4th
714	6.....	.10	.75	"	" "

No. 29, 714



Htg.

RATCHETS

Catalogue No.	CLASS	PRICE		DESCRIPTION OF MOVEMENT		
		Piece	Per Doz.	Size	Model	
10	1.....	.15	1.50	18	F. Pl.	1st
10	2 to 4.....	.10	1.00	"	"	"
10	5, 6, 61.....	.10	.75	"	"	"
87	12 to 14.....	.20	2.00	"	1/4 PL	6th
716	15.....	.10	.75	17	F. Pl.	1st
87	16 to 23.....	.20	2.00	16	1/4 PL	1st, 2d
718	42, 43.....	.10	1.00	14	"	1st
719	44, 45.....	.10	1.00	12	"	"
719	46 to 48.....	.15	1.50	10	"	"

No. 10



Htg.

No. 87



Htg. or O. F.

No. 716



Htg.

No. 718



Htg.

No. 719



Htg.

RINGS, FRICTION

Catalogue No.	CLASS	PRICE		DESCRIPTION OF MOVEMENT		
		Piece	Per Doz.	Size	Model	
31	1 to 5, 119.....	.10	.50	18	F. Pl.	2d to 4th, 10th

No. 31



Htg.

ROLLERS, SAFETY

Catalogue No.	CLASS	PRICE		DESCRIPTION OF MOVEMENT		
		Piece	Per Doz.	Size	Model	
1888	1, 65, 119, 121.....	.30	3.00	18	F. PL	2d to 4th, 7th, 10th, 11th
1888	89 to 91, 99.....	.30	3.00	"	"	8th, 9th
1888	36, 41, 98, 102, 125, 126, 132.....	.30	3.00	16	1/4 PL	6th to 9th, 13th to 15th, 17th
2650	67, 68, 71, 72, 135.....	.30	3.00	12	"	2d to 4th

No. 1888



Htg. or O. F.

No. 2650



Htg. or O. F.

Your Jobber will supply Balance Staffs, Balance Jewels, Roller Jewels, Hands and Screws in Dozen lots in original Sealed Trade-Marked Packages.



[TOP]

TRADE-MARKED PACKAGE



[BOTTOM]

ROLLERS, TABLE

Catalogue No.	CLASS	PRICE			DESCRIPTION OF MOVEMENT	
		Piece	Per Doz.	Size	Model	
749	1 to 4, 7 to 9, 65, 66, 118, 120	.15	1.50	18	F. Pl.	1st to 5th, 7th, 10th, 11th
749	5, 6, 10, 11, 61 to 64, 103 to 106, 122 to 124	.10	1.00	"	"	1st to 5th, 7th
*1884	1, 65, 119, 121	.15	1.50	"	"	2d to 4th, 7th, 10th, 11th
749	12 to 14	.15	1.50	"	3/4 Pl.	6th
*1884	89 to 91, 99	.15	1.50	"	"	8th, 9th
1885	90, 91, 99	.15	1.50	"	"	"
749	15	.10	1.00	17	F. Pl.	1st, 2d
749	16 to 19, 21 to 25, 27 to 30, 32 to 34, 36 to 39, 41, 98, 102, 107, 108	.15	1.50	16	3/4 Pl.	1st to 7th, 9th
749	20, 26, 31, 35, 40, 92 to 95, 109, 110, 127	.10	1.00	"	"	1st, 3d to 5th, 7th, 9th
*1884	36, 41, 98, 102, 125, 126, 132	.15	1.50	"	"	6th to 9th, 13th to 15th, 17th
759	42, 43	.15	1.50	14	"	1st
759	128, 129	.10	1.00	"	"	2d
759	44, 45	.15	1.50	12	"	1st
759	67 to 69, 71 to 73	.15	1.50	"	"	2d, 3d
759	70, 74, 87, 88, 100, 101, 111 to 114	.10	1.00	"	"	"
*2654	67, 68, 71, 72, 135	.15	1.50	"	"	2d to 4th
759	46 to 48	.15	1.50	10	"	1st
759	49 to 51, 53 to 55	.15	1.50	6	"	1st, 2d
759	52, 56, 75, 115	.10	1.00	"	"	"
761	57 to 59, 76, 77, 80, 81	.15	1.50	0	"	1st to 3d
761	60, 78, 79, 82 to 86, 116, 117	.10	1.00	"	"	"
1886	96, 97	.15	1.50	10/0	"	1st

*Used in connection with Safety Roller in Double Roller Escapement.

The notes under Rollers, Table, with Jewels Fitted, also apply to Rollers, Table.

ROLLERS, TABLE
WITH JEWELS FITTED

Catalogue No.	CLASS	PRICE			DESCRIPTION OF MOVEMENT		Jewel
		Piece	Per Doz.	Size	Model		
2068	1 to 4, 7 to 9, 65, 66, 118, 120	.25	2.50	18	F. Pl.	1st to 5th, 7th, 10th, 11th	Garnet
2068	5, 6, 10, 11, 61 to 64, 103 to 106, 122 to 124	.20	2.00	"	"	1st to 5th, 7th	"
*2382	1, 65, 119, 121	.40	4.00	"	"	2d to 4th, 7th, 10th, 11th	Sapphire
2068	12 to 14	.25	2.50	"	3/4 Pl.	6th	Garnet
*2382	89 to 91, 99	.40	4.00	"	"	8th, 9th	Sapphire
2385	90, 91, 99	.25	2.50	"	"	"	Garnet
2068	15	.30	3.00	17	F. Pl.	1st, 2d	"
20688	16, 21, 36, 41	.40	4.00	16	3/4 Pl.	1st, 2d, 6th, 7th	Sapphire
2068	17 to 19, 22 to 25, 27 to 30, 32 to 34, 37 to 39, 98, 102, 107, 108	.25	2.50	"	"	1st to 7th, 9th	Garnet
2068	20, 26, 31, 35, 40, 92 to 95, 109, 110, 127	.20	2.00	"	"	1st, 3d, 5th to 7th, 9th	"
*2382	36, 41, 98, 102, 125, 126, 132	.40	4.00	"	"	6th to 9th, 13th to 15th, 17th	Sapphire
2432	42, 43	.25	2.50	14	"	1st	Garnet
2432	128, 129	.20	2.00	"	"	2d	"
2432	44, 45	.25	2.50	12	"	1st	"
24328	67, 71	.40	4.00	"	"	2d, 3d	Sapphire
2432	68, 69, 72, 73	.25	2.50	"	"	"	Garnet
2432	70, 74, 87, 88, 100, 101, 111 to 114	.20	2.00	"	"	"	"
*2700	67, 68, 71, 72	.40	4.00	"	"	"	Sapphire
*2999	135	.25	2.50	"	"	4th	Garnet
2432	46 to 48	.25	2.50	10	"	1st	"
2432	49 to 51, 53 to 55	.25	2.50	6	"	1st, 2d	"
2432	52, 56, 75, 115	.20	2.00	"	"	"	"
2433	57 to 59, 76, 77, 80, 81	.25	2.50	0	"	1st to 3d	"
2433	60, 78, 79, 82 to 86, 116, 117	.20	2.00	"	"	"	"
2434	96, 97	.25	2.50	10/0	"	1st	"

*Used in connection with Safety Roller in Double Roller Escapement.

S, affixed to numbers 2068 and 2432, indicates Sapphire Jewel.

Standard diameters of Single Roller Tables are as follows:

Inches	Millimeters
18 and 16 Size .150	3.81
12 and 6 Size .124	3.15
0 Size .100	2.54
10/0 Size .068	1.73

In addition to rollers of standard diameter we use and are prepared to furnish for repairs rollers of larger and smaller diameter than standard.

This system makes it possible to get the correct safety action without bending the guard pin.

In ordering other than standard rollers specify whether small or large are wanted in addition to catalogue number.

The standard diameter of hole in roller No. 749 is .024 inches (.60 mm.). In some of the earlier 16 size movements (those made prior to No. 2,000,000) rollers with .020 inches (.50 mm.) holes were used.

If those having small holes are required specify "small holes" in addition to catalogue number.

ROLLERS, COMBINATION

Catalogue No.	CLASS	PRICE		DESCRIPTION OF MOVEMENT		
		Piece	Per Dos.	Size	Model	
2651	106, 124.....	.50	5.50	18	F. Pl.	5th, 7th
2651	134.....	.55	6.50	"	3/4 Pl.	8th
2651	130, 131.....	.50	5.50	"	"	8th, 9th
2651	98.....	.55	6.50	16	"	15th
2651	33, 38, 107, 108.....	.50	5.50	"	"	6th, 7th
2868	109, 110, 127.....	.50	5.50	"	"	6th, 7th, 9th
2869	128, 129.....	.50	5.50	14	"	2d
2869	135.....	.55	6.50	12	"	4th
2869	111 to 114.....	.50	5.50	"	"	2d, 3d
2652	76, 77, 80, 81.....	.55	6.50	0	"	"
2652	116, 117.....	.50	5.50	"	"	"
2653	133, 136.....	.50	6.00	5/0	"	1st, 2d
2653	96, 97.....	.50	6.00	10/0	"	1st

No. 2651, 2868	No. 2652	No. 2653	No. 2869
Htg. or O. F.	Htg. or O. F.	Htg. or O. F.	Htg. or O. F.

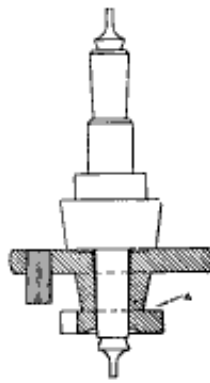

A combination roller consists of the table and safety rollers permanently fitted together. The illustration to the left represents this type of roller fitted to a staff.

In removing combination rollers from the staff place the jaws of the roller remover under the shoulder "A" at right angles to the crescent.

Combination Type of Double Roller

"A" is the table roller and "B" the safety roller located in their correct positions on the staff.

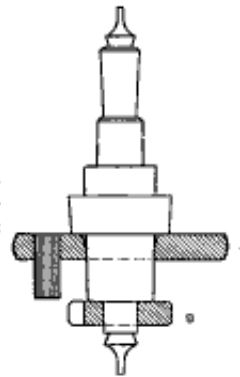

Two-piece Type of Double Roller

ROLLERS, COMBINATION WITH JEWELS FITTED















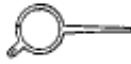





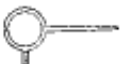









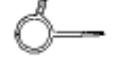





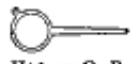

Catalogue No.	CLASS	PRICE		DESCRIPTION OF MOVEMENT			Jewel
		Piece	Per Dos.	Size	Model		
2696	106, 124.....	.55	6.50	18	F. Pl.	5th, 7th	Garnet
2695	134.....	.75	9.00	"	3/4 Pl.	8th	Sapphire
2696	130, 131.....	.55	6.50	"	"	8th, 9th	Garnet
2695	98.....	.75	9.00	16	"	15th	Sapphire
2696	33, 38, 107, 108.....	.55	6.50	"	"	6th, 7th	Garnet
2870	109, 110, 127.....	.56	6.50	"	"	6th, 7th, 9th	"
2872	128, 129.....	.55	6.50	14	"	2d	"
2871	135.....	.75	9.00	12	"	4th	Sapphire
2872	111 to 114.....	.55	6.50	"	"	2d, 3d	Garnet
2697	76, 80.....	.75	9.00	0	"	"	Sapphire
2698	77, 81.....	.65	7.50	"	"	"	Garnet
2698	116, 117.....	.55	6.50	"	"	"	"
2699	133, 136.....	.60	7.00	5/0	"	1st, 2d	"
2699	96, 97.....	.60	7.00	10/0	"	1st	"

REGULATORS

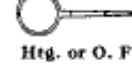
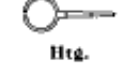
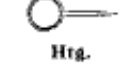
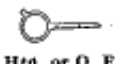
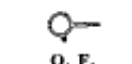
Catalogue No.	CLASS	PRICE		DESCRIPTION OF MOVEMENT			Pat.	Kind of Hair Spring
		Piece	Per Doz.	Size	Model	Pat.		
2515	119, 121	.70	8.00	18	F. Pl.	10th, 11th	Pat.	Breguet
2515	118, 120	.50	5.00	"	"	"	"	"
2601	65	.40	4.00	"	"	7th	"	"
720	1 to 5, 7 to 10, 61 to 66, 103 to 106	.35	3.50	"	"	1st to 5th, 7th	"	"
720	122 to 124	.35	3.50	"	"	4th, 7th	"	Flat
721	1 to 4, 9	.35	3.50	"	"	1st to 5th	"	"
722	1 to 5, 9, 10, 61	.35	3.50	"	"	"	"	"
1540	6, 11, 61, 63, 103, 106	.35	3.50	"	"	2d to 5th	"	Breguet
723	6	.25	2.50	"	"	1st to 4th	Pat.	Flat
724	6	.25	2.50	"	"	"	"	"
725	11	.25	2.50	"	"	"	"	"
2644	89	.50	5.00	"	3/4 Pl.	5th	Pat.	Breguet
2644	90, 91, 99, 134	.35	3.50	"	"	8th, 9th	"	"
1889	89	.50	5.00	"	"	8th	"	"
1889	90, 91, 99, 130, 131	.35	3.50	"	"	8th, 9th	"	"
730	12	.35	3.50	"	"	6th	"	Flat
731	13, 14	.25	2.50	"	"	"	"	"
737	15	.25	2.50	17	F. Pl.	1st	"	"
726	15	.25	2.50	"	"	2d	"	"
728	16	.50	5.00	16	3/4 Pl.	1st	Pat.	Breguet
728	17	.35	3.50	"	"	"	"	"
729	17, 32 to 34, 37 to 39, 98, 102, 107 to 110	.35	3.50	"	"	1st, 6th to 9th, 13th	"	"
729	125, 127	.35	3.50	"	"	8th, 9th	"	Flat
730	17, 18	.35	3.50	"	"	1st	"	"
731	18, 19, 24, 25, 27, 28	.25	2.50	"	"	1st, 3d, 4th	Pat.	"
732	20, 26	.25	2.50	"	"	1st, 3d	"	"
733	21	.50	5.00	"	"	2d	Pat.	Breguet
733	22	.40	4.00	"	"	"	"	"
734	22	.40	4.00	"	"	"	"	Flat
735	23	.35	3.50	"	"	"	"	"
736	24, 29	.35	3.50	"	"	3d, 5th	Pat.	Breguet
737	25	.25	2.50	"	"	3d	Pat.	Flat
738	30	.25	2.50	"	"	5th	"	"
739	31	.25	2.50	"	"	"	"	"
1467	35, 40, 93, 95, 107 to 110	.25	2.50	"	"	6th, 7th	Pat.	Breguet
1488	35, 40, 92, 94, 109, 110	.25	2.50	"	"	"	"	"
1489	36, 41	.50	5.00	"	"	"	Pat.	"
2185	35, 40, 92, 94	.25	2.50	"	"	"	"	"
2646	109, 110	.35	3.50	"	"	"	Pat.	"
2645	132	.50	5.00	"	"	15th	"	Breguet
2645	98, 102, 126	.35	3.50	"	"	14th, 15th, 17th	"	"
731	42	.35	3.50	14	"	1st	"	Flat
731	43	.25	2.50	"	"	"	"	"
1961	128, 129	.35	3.50	"	"	2d	Pat.	Breguet
2648	128	.35	3.50	"	"	"	"	"
740	44	.35	3.50	12	"	1st	"	Flat
741	45	.25	2.50	"	"	"	"	"
1890	67	.50	5.00	"	"	2d	Pat.	Breguet
1890	68	.40	4.00	"	"	"	"	"
1890	69, 100, 111, 113	.35	3.50	"	"	"	"	"
2647	113	.35	3.50	"	"	"	"	"
1891	70, 87, 113	.25	2.50	"	"	"	Pat.	"
2119	70, 87, 113	.25	2.50	"	"	"	"	"
1961	71	.50	5.00	"	"	3d	Pat.	"
1961	72	.40	4.00	"	"	"	"	"
1961	73, 101, 112, 114	.35	3.50	"	"	"	"	"
2648	114	.35	3.50	"	"	"	"	"
1962	74, 88, 114	.25	2.50	"	"	"	Pat.	"
2120	74, 88, 114	.25	2.50	"	"	"	"	"
2764	135	.50	5.00	"	"	4th	Pat.	"
740	46, 47	.35	3.50	10	"	1st	"	Flat
741	48	.25	2.50	"	"	"	"	"
742	49, 53, 54	.35	3.50	6	"	1st, 2d	"	Breguet
743	50, 54	.35	3.50	"	"	"	"	Flat
744	51, 55	.25	2.50	"	"	"	"	"
745	52, 56	.25	2.50	"	"	"	"	"
1542	53, 54, 56	.35	3.50	"	"	2d	Pat.	Breguet
2179	56, 75, 115	.25	2.50	"	"	"	"	"
1543	57, 58, 60	.35	3.50	0	"	1st	Pat.	"
746	57, 58	.35	3.50	"	"	"	"	"
746	60	.2	2.50	"	"	"	"	Flat
747	58	.35	3.50	"	"	"	"	Oval
748	59, 60	.25	2.50	"	"	"	"	Flat
2180	84	.25	2.50	"	"	"	"	Breguet
2649	116	.35	3.50	"	"	2d	"	"
1892	76, 77, 80, 81, 116, 117	.35	3.50	"	"	2d, 3d	Pat.	"
1963	78, 79, 82, 83, 85, 86, 116, 117	.25	2.50	"	"	"	"	"
2880	133, 136	.35	3.50	5/0	"	1st, 2d	"	"
1893	96	.50	5.00	10/0	"	1st	"	"
1893	97	.35	3.50	"	"	"	"	"

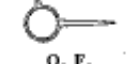
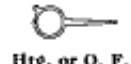
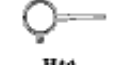
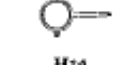
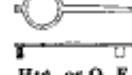
Owing to the fact that in many instances difficulty is experienced by the trade in applying regulators to our 12 size 2d and 3d models of watches, special attention is called to the location of the index on these two models. It will be observed that the index is not on the cock, but on the train bridge. When the regulator is placed in this position the pins will be in the correct place.

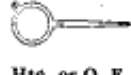
REGULATORS

No. 720  Htg. or O. F.	No. 721, 722  Htg. or O. F.	No. 723  Htg.	No. 724  Htg.	No. 725  O. F.
No. 726  Htg.	No. 727  Htg.	No. 728  Htg. or O. F.	No. 729, 1469, 2646  Htg. or O. F.	No. 730  Htg. or O. F.
No. 731  Htg. or O. F.	No. 732  Htg. or O. F.	No. 733  Htg. or O. F.	No. 734  Htg. or O. F.	No. 735  Htg. or O. F.
No. 736  Htg. or O. F.	No. 737  Htg.	No. 738  O. F.	No. 739  O. F.	No. 740  Htg.
No. 741  Htg.	No. 742  Htg.	No. 743  Htg.	No. 744  Htg.	No. 745  Htg.
No. 746  Htg.	No. 747  Htg.	No. 748  Htg.	No. 1467, 1468, 2615  Htg. or O. F.	No. 1540  Htg. or O. F.
No. 1542  Htg.	No. 1543  Htg.	No. 1889  Htg. or O. F.	No. 1890, 2647  Htg.	No. 1891, 2119  Htg.
No. 1892, 2649  Htg. or O. F.	No. 1893  O. F.	No. 1961, 2648  O. F.	No. 1962, 2120  O. F.	No. 1963  Htg. or O. F.
No. 2179  Htg.	No. 2180  Htg.	No. 2515  Htg. or O. F.	No. 2601  O. F.	No. 2644, 2645  Htg. or O. F.
	No. 2764  O. F.	No. 2880  Htg. or O. F.		

SCREWS, USE AND NUMBER

Catalogue No.	ARTICLE	CLASS	DESCRIPTION OF MOVEMENT		Diam. Tap	Threads Per In.
			Size	Model		
885	Arm Vibrating	1 to 4, 119.	18	1st to 4th, 10th	.0428	120
888	Balance, Composition	1 to 11, 61, 63, 105, 106, 122 to 124, 130, 131	"	1st to 5th, 7th to 9th	.0208	220
887	"	1 to 11, 62, 64, 66, 103, 104, 122	"	1st to 5th, 7th	.0208	220
2519	"	118, 120	"	10th, 11th	.0208	220
1568	"	12 to 14	"	6th	.0208	220
1568	"	16 to 41, 92 to 95, 107 to 110, 127	16	1st to 7th, 9th	.0208	220
1569	"	42, 43	14	1st	.0168	260
1997	"	128, 129	"	2d	.0208	220
1569	"	44, 45	12	1st	.0168	260
1997	"	69, 70, 73, 74, 87, 88, 100, 101, 111 to 114	"	2d, 3d	.0208	220
1569	"	46 to 48	10	1st	.0168	260
1569	"	49 to 56, 75, 115	6	1st, 2d	.0168	260
1574	"	57 to 60	0	1st	.0128	360
2728	"	78, 79, 82 to 86, 116, 117	"	2d, 3d	.0148	320
2728	"	116, 117	3/0	"	.0148	320
2729	"	133, 136	5/0	1st, 2d	.0128	360
2729	"	97	10/0	1st	.0128	360
2838	"	97	"	"	.0128	360
886	"	Gold	18	1st to 5th, 7th, 8th	.0208	220
2042	"	"	"	8th, 9th	.0208	220
2520	"	"	"	10th, 11th	.0208	220
886	"	"	16	1st to 9th, 13th to 15th, 17th	.0208	220
1570	"	"	14	1st	.0168	260
1570	"	"	12	"	.0168	260
2282	"	"	"	2d, 3d	.0208	220
2284	"	"	"	4th	.0148	320
1570	"	"	10	1st	.0168	260
1570	"	"	6	1st, 2d	.0168	260
1571	"	"	0	1st	.0128	360
2284	"	"	"	2d, 3d	.0148	320
2285	"	"	10/0	1st	.0128	360
890	Banking, Brass	1 to 11, 61 to 64, 66, 103 to 106, 118, 120	18	1st to 5th, 7th, 10th, 11th	.0548	180
1582	"	12 to 14	"	6th	.0488	200
1576	"	15	17	1st, 2d	.0548	180
1575	"	16 to 41, 92 to 95, 107 to 110	16	1st to 7th	.0488	200
1575	"	42, 43	14	1st	.0488	200
1575	"	46, 48	12	1st	.0488	200
2022	"	113, 114	"	2d, 3d	.0488	200
2833	"	113, 114	"	"	.0488	200
1575	"	46 to 48	10	1st	.0488	200
1577	"	49 to 56, 75, 115	6	1st, 2d	.0488	200
1578	"	57 to 60	0	1st	.0408	200
2300	"	84	"	"	.0408	200
2022	"	116, 117	"	2d, 3d	.0488	200
2833	"	116, 117	"	"	.0488	200
889	"	Gold	18	1st to 5th, 7th, 10th, 11th	.0548	180
1579	"	16 to 41	16	1st to 7th	.0488	220
2301	"	Nickel	18	1st to 5th, 7th, 10th, 11th	.0548	180
2306	"	"	"	8th, 9th	.0548	180
2302	"	"	16	1st to 9th, 13th to 15th, 17th	.0488	200
2302	"	42, 43	14	1st	.0488	200
2306	"	128, 129	"	2d	.0488	200
2837	"	128, 129	"	"	.0488	200
2306	"	67 to 74, 87, 88, 100, 101, 111 to 114	12	2d, 3d	.0488	200
2837	"	113, 114	"	"	.0488	200
2616	"	135	"	4th	.0488	200
2304	"	49 to 56, 75, 115	6	1st, 2d	.0488	200
2051	"	84	0	1st	.0408	200
2303	"	57 to 60, 76 to 83, 85, 86, 116, 117	"	1st to 3d	.0408	200
2306	"	76, 77, 80, 81, 116, 117	"	2d, 3d	.0488	200
2837	"	116, 117	"	"	.0488	200
2837	"	116, 117	3/0	"	.0488	200
2027	"	133, 136	5/0	1st, 2d	.0408	200
2027	"	96, 97	10/0	1st	.0408	200
907	Bar, Setting	4, 5, 118	18	2d to 4th, 10th	.0368	140
891	"	49 to 51	6	1st	.0368	140
895	Bridge Arbor, Sweep	27, 28	16	4th	.0428	120
1747	Second	63, 64, 104, 106, 124	18	5th, 7th	.0608	110
893	Bridge	7 to 11, 65, 66, 122	"	"	.0468	110
2444	"	9, 65, 120, 121	"	5th, 7th, 11th	.0468	110
1583	"	12 to 14	"	6th	.0428	120
2036	"	89 to 91, 99, 130, 131, 134	"	8th, 9th	.0428	120
1583	"	16 to 23	16	1st, 2d	.0428	120
1584	"	32 to 41, 92 to 95, 98, 102, 107 to 110, 125 to 127, 132	"	6th to 9th, 13th to 15th, 17th	.0428	120
2612	"	128, 129	14	2d	.0428	120
1999	"	67 to 74, 87, 88, 100, 101, 111 to 114	12	2d, 3d	.0428	120
2614	"	135	"	4th	.0428	120
1585	"	46 to 48	10	1st	.0428	120
2012	"	76 to 83, 85, 86, 116, 117	0	2d, 3d	.0368	140
2012	"	116, 117	3/0	"	.0368	140
2030	"	133, 136	5/0	1st, 2d	.0308	180

SCREWS, USE AND NUMBER—Continued

Catalogue No.	ARTICLE	CLASS	DESCRIPTION OF MOVEMENT		Diam. Tap	Threads Per In.
			Size	Model		
2030	Bridge, Barrel	96, 97	10/0	1st	.0308	180
892	" Bevel Pinion	5, 6	18	2d to 4th	.0428	120
1611	" " "	61 to 64	"	2d to 5th	.0608	110
1999	" " "	61 to 64, 103 to 106, 124	"	2d to 5th, 7th	.0428	120
2298	" " "	61, 62, 103, 105, 123	"	2d to 4th	.0428	120
2443	" " "	9, 65, 122	"	5th, 7th	.0428	120
896	" " "	1 to 6, 118, 119	" Long	2d to 4th, 10th	.0368	140
897	" " "	1 to 6, 118, 119	" Short	"	.0368	140
892	" " "	15	17	2d	.0428	120
894	" Pallet	12 to 14	18	6th	.0428	120
2037	" " "	89 to 91, 99, 130, 131, 134	"	8th, 9th	.0428	120
894	" " "	16 to 23, 32 to 41, 92 to 95, 98, 102, 107 to 110, 125 to 127, 132	16	1st, 2d, 6th to 9th, 13th to 15th, 17th	.0428	120
1586	" " "	24 to 31	"	3d to 5th	.0428	120
894	" " "	42, 43	14	1st	.0428	120
2000	" " "	128, 129	"	2d	.0428	120
894	" " "	44, 45	12	1st	.0428	120
2000	" " "	67 to 74, 87, 88, 100, 101, 111 to 114, 135	"	2d to 4th	.0428	120
894	" " "	46 to 48	10	1st	.0428	120
1587	" " "	49 to 56, 75, 115	6	1st, 2d	.0428	120
1588	" " "	57 to 60	0	1st	.0248	220
912	" " "	84	"	"	.0248	220
2013	" " "	70 to 83, 85, 86, 116, 117	"	2d, 3d	.0368	140
2013	" " "	116, 117	3/0	"	.0368	140
2031	" " "	133, 136	5/0	1st, 2d	.0308	180
2031	" " "	96, 97	10/0	1st	.0308	180
916	Cam, Setting	1 to 4, 119	18	2d, to 4th, 10th	.0368	140
898	" " "	7 to 11, 120	"	5th, 11th	.0488	140
898	" " "	12 to 14	"	6th	.0488	140
1599	" " Spring	32 to 41, 92 to 95, 107 to 110	16	6th, 7th	.0368	140
2289	" " "	41	"	7th	.0368	140
2002	" " "	67 to 70, 72 to 74, 135	12	2d to 4th	.0428	120
2025	" " "	71	"	3d	.0428	120
2014	" " "	76 to 83, 85, 86, 116, 117	0	2d, 3d	.0368	140
2014	" " "	116, 117	3/0	"	.0368	140
2025	" " "	133, 136	5/0	1st, 2d	.0248	220
2079	" " "	136	"	2d	.0248	220
2020	" " "	96, 97	10/0	1st	.0168	200
912	Cap, Arbor	24 to 26	16	3d	.0248	220
899	" Bridge, Ratchet	1 to 6, 118, 119	18	2d to 4th, 10th	.0428	120
922	" " "	1 to 6, 61	"	1st	.0428	120
901	" " "	1 to 4, 119	" Long	2d to 4th, 10th	.0428	120
902	" " "	1 to 4, 119	" Short	"	.0428	120
922	" " "	15	17	1st	.0428	120
912	" " "	44, 45	12	"	.0248	220
912	" " "	46 to 48	10	"	.0248	220
903	Case	1 to 11, 61 to 66, 103 to 106, 118 to 124	18	1st to 5th, 7th, 10th, 11th	.0428	120
903	" " "	12 to 14	"	6th	.0428	120
2034	" " "	89 to 91, 99, 130, 131, 134	"	8th, 9th	.0428	120
1589	" " "	15	17	1st, 2d	.0548	110
1590	" " "	16 to 31	16	1st to 5th	.0428	120
1591	" " "	32 to 41, 92 to 95, 98, 102, 107 to 110, 125 to 127, 132	"	6th to 9th, 13th to 15th, 17th	.0428	120
1592	" " "	42, 43	14	1st	.0428	120
2331	" " "	128, 129	"	2d	.0428	120
1590	" " "	44, 45	12	1st	.0428	120
1998	" " "	67 to 74, 87, 88, 100, 101, 111 to 114, 135	"	2d, 3d	.0428	120
2030	" " "	135	"	4th	.0428	120
1590	" " "	46 to 48	10	1st	.0428	120
1594	" " "	49 to 56, 75, 115	6	1st, 2d	.0428	120
1595	" " "	57 to 60, 70 to 80, 116, 117	0	1st to 3d	.0368	140
2836	" " "	81, 116, 117	0r12	2d, 3d	.0368	140
2057	" " "	116, 117	3/0	"	.0368	140
2029	" " "	133, 136	5/0	1st, 2d	.0308	180
2029	" " "	96, 97	10/0	1st	.0308	180
904	Clamp, Ratchet	12 to 14	18	6th	.0248	220
904	" " "	16 to 23	16	1st, 2d	.0248	220
926	" Minute Wheel	65, 106	18	5th, 7th	.0248	220
926	" " "	32 to 41, 92 to 95, 98, 102, 107 to 110, 125 to 127, 132	16	6th to 9th, 13th to 15th, 17th	.0248	220
2023	" " "	128, 129	14	2d	.0248	220
2023	" " "	67 to 74, 87, 88, 100, 101, 111 to 114, 135	12	2d to 4th	.0248	220
2018	" " "	116, 117	0	2d, 3d	.0248	220
2018	" " "	116, 117	3/0	"	.0248	220
2047	" " "	133, 136	5/0	1st, 2d	.0208	220
2047	" " "	96, 97	10/0	1st	.0208	220
2021	" Ratchet	80 to 91, 99	18	8th, 9th	.0248	220
2621	" " "	41, 98, 102, 126, 132	16	7th, 13th to 15th, 17th	.0248	220
2009	" " "	67 to 74	12	2d, 3d	.0248	220
2017	" " "	76 to 83, 85, 86	0	"	.0208	220
2038	" Setting	89 to 91, 99, 130, 131, 134	18	8th, 9th	.0368	140
910	" " "	24 to 28	16	3d, 4th	.0248	220
2018	" " "	76 to 83, 85, 86, 116, 117	0	2d, 3d	.0248	220
2047	" " "	96, 97	10/0	1st	.0208	220
2882	" Pallet Jewel	135	12	4th	.0168	200

SCREWS, USE AND NUMBER—Continued

Catalogue No.	ARTICLE	CLASS	DESCRIPTION OF MOVEMENT		Diam. Tap	Threads Per In.
			Size	Model		
1722	Click	7, 65, 121, 122, 124	18	2d to 5th, 7th, 11th	.0368	140
1601	"	91, 130, 131	"	8th, 9th	.0368	140
2292	"	89 to 91, 99, 130, 131, 134	"	"	.0368	140
1601	"	32 to 41, 92 to 95, 102, 107 to 110, 125	16	6th to 9th	.0368	140
2291	"	41, 98, 102, 126, 132	"	7th, 13th to 15th	.0368	140
2292	"	32, 36, 37, 41, 98, 102, 126, 127, 132	"	6th, 7th, 9th, 13th to 15th, 17th	.0368	140
906	"	42, 43	14	1st	.0368	140
2003	"	128, 129	"	2d	.0368	140
2003	"	67 to 74, 87, 88, 100, 101, 111 to 114, 135	12	2d to 4th	.0368	140
2016	"	76 to 83, 85, 86, 116, 117	0	2d, 3d	.0268	180
2016	"	116, 117	3/0	"	.0268	180
2045	"	133, 136	5/0	1st, 2d	.0208	220
2045	"	96, 97	10/0	1st	.0208	220
907	Clutch, Setting	1 to 4, 119	18	2d to 4th, 10th	.0368	140
908	Cock	1 to 11, 65, 66, 103, 104, 118 to 122, 124	"	1st to 5th, 7th, 10th, 11th	.0468	110
1749	"	61 to 64, 105, 106, 123	"	2d to 5th	.0608	110
1596	"	12 to 14	"	6th	.0448	110
2036	"	89 to 91, 99, 130, 131, 134	"	8th, 9th	.0428	120
921	"	15	17	1st, 2d	.0468	110
1596	"	16 to 28	16	1st to 4th	.0448	110
1585	"	29 to 31	"	5th	.0428	120
1584	"	32 to 41, 92 to 95, 98, 102, 107 to 110, 125 to 127, 132	"	6th to 9th, 13th to 15th, 17th	.0428	120
1597	"	42, 43	14	1st	.0448	110
2612	"	128, 129	"	2d	.0428	120
1598	"	44, 45	12	1st	.0428	120
1999	"	67 to 74, 87, 88, 100, 101, 111 to 114, 135	"	2d, 3d	.0428	120
2614	"	135	"	4th	.0428	120
1598	"	46 to 48	10	1st	.0428	120
935	"	49 to 56, 75, 115	6	1st, 2d	.0428	120
899	"	57 to 60, 84	0	1st	.0428	120
2012	"	76 to 83, 85, 86, 116, 117	"	2d, 3d	.0368	140
2012	"	116, 117	3/0	"	.0368	140
2030	"	133, 136	5/0	1st, 2d	.0308	180
2030	"	96, 97	10/0	1st	.0308	180
909	Cup, Arbor	1 to 6	18	"	.0268	180
910	"	1 to 6, 61	"	Wide Base	.0248	220
909	"	42, 43	14	"	.0268	180
911	Dial Foot	1 to 11, 61 to 66, 103 to 106, 118 to 124	18	1st to 5th, 7th, 10th, 11th	.0368	140
911	"	12 to 14	"	6th	.0368	140
2039	"	89 to 91, 99, 130, 131, 134	"	8th, 9th	.0368	140
912	"	16 to 41	16	1st to 7th	.0248	220
2438	"	32 to 41, 92 to 95, 98, 102, 107 to 110, 125 to 127, 132	"	6th to 9th, 13th to 15th, 17th	.0248	220
2608	"	128, 129	14	2d	.0248	220
2438	"	67 to 74, 87, 88, 100, 101, 111 to 114, 135	12	2d to 4th	.0248	220
1600	"	49 to 56, 75, 115	6	1st, 2d	.0248	220
2440	"	57 to 60, 84	0	1st	.0248	220
2019	"	76 to 83, 85, 86, 116, 117	"	2d, 3d	.0248	220
2822	"	116, 117	"	"	.0248	220
2911	"	116, 117	3/0	"	.0248	220
2441	"	133, 136	5/0	1st, 2d	.0208	220
2441	"	96, 97	10/0	1st	.0208	220
2429	Hub, Barrel	89 to 91, 99	18	8th, 9th
2730	"	41, 98, 102, 126, 132	16	7th, 13th to 15th, 17th
2430	"	67 to 74	12	2d, 3d
2431	"	76 to 83	0	"
912	Index	1 to 11, 61 to 66, 103 to 106, 122 to 124	18	1st to 5th, 7th	.0248	220
912	"	12 to 14	"	6th	.0248	220
910	"	89 to 91, 99, 130, 131, 134	"	8th, 9th	.0248	220
910	"	16 to 23	16	1st, 2d	.0248	220
1603	"	32 to 41, 92 to 95, 98, 102, 107 to 110, 125 to 127, 132	"	6th to 9th, 13th to 15th, 17th	.0248	220
2024	"	128, 129	14	2d	.0208	220
2024	"	67 to 74, 87, 88, 100, 101, 111 to 114, 135	12	2d to 4th	.0208	220
2024	"	53 to 56	6	2d	.0208	220
2024	"	57 to 60	0	1st	.0208	220
2011	"	76, 77, 80, 81, 116, 117	"	2d, 3d	.0168	260
2011	"	116, 117	3/0	"	.0168	260
913	Jewel, Balance, Upper	1 to 11, 61 to 66, 103 to 106, 122 to 124	18	1st to 5th, 7th	.0248	220
913	"	12 to 14	"	6th	.0248	220
913	"	90, 91, 99, 130, 131, 134	"	8th, 9th	.0248	220
2293	"	89	"	8th	.0208	220
2049	"	118 to 121	"	10th, 11th	.0208	220
2023	"	90, 91	"	8th	.0248	220
914	"	15	17	1st, 2d	.0268	180
913	"	16 to 41, 92 to 95, 98, 102, 107 to 110, 125, 127	16	1st to 9th, 13th	.0248	220
2293	"	36, 41, 98, 132	"	6th, 7th, 13th, 15th	.0208	220
2023	"	98, 102, 126	"	14th, 15th, 17th	.0248	220
913	"	42, 43	14	1st	.0248	220
1604	"	128, 129	"	2d	.0208	220
1604	"	44, 45, 68 to 70, 72 to 74, 87, 88, 100, 101, 111 to 114	12	1st to 3d	.0208	220

SCREWS, USE AND NUMBER—Continued

Catalogue No.	ARTICLE	CLASS	DESCRIPTION OF MOVEMENT		Diam. Tap	Threads Per In.
			Size	Model		
2008	Jewel, Balance, Upper	67, 71, 135	Dome	12	2d to 4th	.0208 220
2824	"	135	"	"	4th	.0208 220
1604	"	46 to 48	"	10	1st	.0208 220
1604	"	49 to 56, 75, 115	"	6	1st, 2d	.0208 220
2020	"	57 to 60, 76 to 86, 116, 117	"	0	1st to 3d	.0168 260
2020	"	116, 117	"	3/0	2d, 3d	.0168 260
2048	"	133, 136	"	5/0	1st, 2d	.0148 320
2048	"	96, 97	"	10/0	1st	.0148 320
913	"	1 to 11, 61 to 66, 103 to 106, 118 to 124	"	18	1st to 5th, 7th, 10th, 11th	.0248 220
913	"	12 to 14	"	"	6th	.0248 220
913	"	89 to 91, 99, 130, 131, 134	"	"	8th, 9th	.0248 220
914	"	15	"	17	1st, 2d	.0208 180
913	"	16 to 41, 92 to 95, 98, 102, 107 to 110, 125, 127	"	16	1st to 9th, 13th	.0248 220
1606	"	41, 98	"	"	7th, 13th	.0248 220
2023	"	98, 102, 126, 132	"	"	14th, 15th, 17th	.0248 220
913	"	42, 43	"	14	1st	.0248 220
2049	"	128, 129	"	"	2d	.0208 220
1604	"	44, 45	"	12	1st	.0208 220
2049	"	67 to 74, 87, 88, 100, 101, 111 to 114	"	"	2d, 3d	.0208 220
1607	"	135	"	"	4th	.0208 220
1604	"	46 to 48	"	10	1st	.0208 220
1604	"	49 to 56, 75, 115	"	6	1st, 2d	.0208 220
2020	"	57 to 60, 76 to 86, 116, 117	"	0	1st to 3d	.0168 260
2020	"	116, 117	"	3/0	2d, 3d	.0168 260
2048	"	133, 136	"	5/0	1st, 2d	.0148 320
2048	"	96, 97	"	10/0	1st	.0148 320
2023	"	89, 91	"	18	8th	.0248 220
2023	Barrel	98, 126, 132	"	16	14th, 15th, 17th	.0248 220
1606	"	41, 98	"	"	7th, 13th	.0248 220
2006	"	67, 68, 71, 72	"	12	2d, 3d	.0208 220
1607	"	76, 80	"	0	"	.0208 220
914	Center, Upper	1 to 11, 62, 64 to 66	"	18	1st to 5th, 7th	.0268 180
913	"	1, 3 to 5, 7 to 10, 62, 64 to 66, 103 to 106, 118 to 124	"	"	1st to 5th, 7th, 10th, 11th	.0248 220
2023	"	89 to 91, 99, 130, 131, 134	"	"	8th, 9th	.0248 220
928	"	90, 91	"	"	8th	.0248 220
1606	"	16 to 23	"	16	1st, 2d	.0248 220
2023	"	32 to 41, 98, 102, 107 to 110, 125, 127	"	"	6th to 9th, 13th	.0248 220
2005	"	98, 102, 126, 132	"	"	14th, 15th, 17th	.0248 220
2005	"	128, 129	"	14	2d	.0208 220
2005	"	111 to 114	"	12	2d, 3d	.0208 220
2006	"	67 to 69, 71 to 73, 100, 101, 135	"	"	2d to 4th	.0208 220
2006	"	70, 74	Bushing	"	2d, 3d	.0208 220
1607	"	53 to 56	"	6	2d	.0208 220
2294	"	54, 56	"	"	"	.0208 220
1607	"	57 to 60	"	0	1st	.0208 220
2294	"	58, 60	"	"	"	.0208 220
2020	"	76, 77, 80, 81	"	"	2d, 3d	.0168 260
2286	"	96	"	10/0	1st	.0148 320
2023	Jewel, Center, Lower	89 to 91, 99, 130, 131, 134	"	18	8th, 9th	.0248 220
913	"	32 to 41, 98, 102, 107 to 110, 125, 127	"	16	6th to 9th, 13th	.0248 220
1606	"	98, 102, 126, 132	"	"	14th, 15th, 17th	.0248 220
2005	"	128, 129	"	14	2d	.0208 220
2005	"	67 to 69, 71 to 73, 100, 101, 111 to 114, 135	"	12	2d to 4th	.0208 220
1607	"	53	"	0	2d	.0208 220
1607	"	57	"	0	1st	.0208 220
2005	"	76, 77, 80, 81	"	"	2d, 3d	.0208 220
914	Escape, Upper	1 to 11	"	18	1st to 5th	.0268 180
913	"	1, 3 to 5, 7 to 10, 61 to 66, 103 to 106, 118 to 124	"	"	1st to 5th, 7th, 10th, 11th	.0248 220
913	"	12, 13	"	"	6th	.0248 220
913	"	89 to 91, 99, 130, 131, 134	"	"	8th, 9th	.0248 220
1604	"	16 to 41, 92, 94, 98, 109, 110, 127	"	16	1st to 9th, 13th	.0248 220
2294	"	32 to 34, 37 to 39, 93, 95, 98, 107, 108	"	"	6th, 7th, 13th	.0208 220
2023	"	98, 102, 125	"	"	8th, 9th, 13th	.0208 220
913	"	98, 102, 126, 132	"	"	14th, 15th, 17th	.0248 220
1604	"	42, 43	"	14	1st	.0248 220
1604	"	128, 129	"	"	2d	.0208 220
2294	"	44, 45, 67 to 74, 87, 88, 111 to 114, 135	"	12	2d to 4th	.0208 220
1604	"	100, 101, 111, 112	"	"	2d, 3d	.0208 220
1604	"	46 to 48	"	10	1st	.0208 220
1604	"	49 to 56, 75, 115	"	6	1st, 2d	.0208 220
2020	"	57 to 60, 76 to 78, 80 to 82, 84 to 86, 116, 117	"	0	1st to 3d	.0168 260
2020	"	116, 117	"	3/0	2d, 3d	.0168 260
2286	"	133, 136	"	5/0	1st, 2d	.0148 320
2286	"	96, 97	"	10/0	1st	.0148 320
1606	"	1, 7, 65, 119, 121	"	18	1st to 5th, 7th, 10th, 11th	.0248 220
913	"	106	"	"	5th	.0248 220
913	"	89 to 91, 99, 134	"	"	8th, 9th	.0248 220
1606	"	36, 41, 98, 126, 132	"	16	6th, 7th, 9th, 13th to 15th, 17th	.0248 220
2023	"	41, 98	"	"	7th, 13th	.0248 220

SCREWS, USE AND NUMBER—Continued

Catalogue No.	ARTICLE	CLASS	DESCRIPTION OF MOVEMENT		Diam. Tap	Threads Per In.
			Size	Model		
2005	Jewel, Escape, Lower	67, 68, 71, 72	12	2d, 3d	.0208	220
1607	"	135	"	4th	.0208	220
914	" Fourth, Upper	1 to 11	18	1st to 5th	.0268	180
913	"	1, 3 to 5, 7 to 10, 61 to 66, 103 to 106, 118 to 124	18	1st to 5th, 7th, 10th, 11th	.0248	220
913	"	12, 13	"	6th	.0248	220
913	"	89 to 91, 99, 130, 131, 134	"	8th, 9th	.0248	220
1604	"	16 to 41, 92, 94, 98, 109, 110, 127	16	1st to 9th, 13th	.0248	220
2023	"	32 to 34, 37 to 39, 93, 95, 98, 102, 107, 108, 125	"	6th to 9th, 13th	.0208	220
913	"	98, 102, 126, 132	"	14th, 15th, 17th	.0248	220
1604	"	42, 43	14	1st	.0248	220
1604	"	128, 129	"	2d	.0208	220
1604	"	44, 45, 67 to 74, 87, 88, 100, 101, 111 to 114, 135	12	1st to 4th	.0208	220
1604	"	46 to 48	10	1st	.0208	220
2020	"	49 to 56, 75, 115	6	1st, 2d	.0208	220
2020	"	57 to 60, 76 to 78, 80 to 82, 84 to 86, 116, 117	0	1st to 3d	.0168	260
2286	"	116, 117	3/0	2d, 3d	.0168	260
2286	"	133, 136	5/0	1st, 2d	.0148	320
1606	"	96, 97	10/0	1st	.0148	320
1606	" Lower	1, 7, 65	18	1st to 5th, 7th	.0248	220
1606	"	89, 90, 99	"	8th, 9th	.0248	220
1606	"	36, 41, 132	16	6th, 7th, 15th	.0248	220
2005	"	67, 68, 71, 72	12	2d, 3d	.0208	220
914	" Pallet, Upper	1 to 11	18	1st to 5th	.0268	180
913	"	1, 3 to 5, 7 to 10, 61 to 66, 103 to 106, 118 to 124	"	1st to 5th, 7th, 10th, 11th	.0248	220
1994	"	89 to 91, 99, 134	"	8th, 9th	.0248	220
1994	"	36, 41, 98, 126, 132	16	6th, 7th, 9th, 13th to 15th, 17th	.0248	220
913	"	127	"	9th	.0248	220
1994	"	67, 68, 71, 72	12	2d, 3d	.0248	220
1606	" Lower	1, 7, 65, 119, 121	18	1st to 5th, 7th, 10th, 11th	.0248	220
913	"	89 to 91, 99, 134	"	8th, 9th	.0248	220
1606	"	36, 41, 98, 126, 132	16	6th, 7th, 9th, 13th to 15th, 17th	.0248	220
2023	"	41, 98	"	7th, 13th	.0248	220
2005	"	67, 68, 71, 72	12	2d, 3d	.0208	220
1607	"	135	"	4th	.0208	220
914	" Third, Upper	1 to 11	18	1st to 5th	.0268	180
913	"	1, 3 to 5, 7 to 10, 61 to 66, 103 to 106, 118 to 124	"	1st to 5th, 7th, 10th, 11th	.0248	220
913	"	12, 13	"	6th	.0248	220
2023	"	89 to 91, 99, 130, 131, 134	"	8th, 9th	.0248	220
913	"	90, 91	"	8th	.0248	220
1607	"	16 to 41, 92, 94, 98, 109, 110, 127	16	1st to 7th, 13th	.0248	220
1604	"	32 to 34, 37 to 39, 92 to 95, 98, 107 to 110, 126	"	6th, 7th, 13th, 14th, 17th	.0208	220
2023	"	98, 102, 125	"	8th, 9th, 13th	.0208	220
913	"	98, 102, 126, 132	"	14th, 15th, 17th	.0248	220
1604	"	42, 43	14	1st	.0248	220
1604	"	128, 129	"	2d	.0208	220
2294	"	44, 45, 67 to 74, 87, 88, 100, 101, 111 to 114, 135	12	1st to 4th	.0208	220
1604	"	74	"	3d	.0208	220
1604	"	46 to 48	10	1st	.0208	220
2020	"	49 to 56, 75, 115	6	1st, 2d	.0208	220
2020	"	57 to 60, 76 to 78, 80 to 82, 84 to 86, 116, 117	0	1st to 3d	.0168	260
2286	"	116, 117	3/0	2d, 3d	.0168	260
2286	"	133, 136	5/0	1st, 2d	.0148	320
1606	" Lower	96, 97	10/0	1st	.0148	320
1606	"	1, 7, 65	18	1st to 5th, 7th	.0248	220
1606	"	89, 90, 99	"	8th, 9th	.0248	220
1606	"	36, 41, 132	16	6th, 7th, 15th	.0248	220
2005	"	67, 68, 71, 72	12	2d, 3d	.0208	220
898	Lever, Cam	12 to 14	18	6th	.0488	140
1996	" Clutch	89 to 91, 99, 130, 131, 134	"	8th, 9th	.0368	140
1601	"	32 to 41	16	6th, 7th	.0368	140
1996	"	32 to 41, 92 to 95, 107 to 110	"	6th to 9th	.0368	140
1722	"	98, 102, 125 to 127, 132	"	8th, 9th, 13th to 15th, 17th	.0368	140
1722	"	128, 129	14	2d	.0368	140
2015	"	67 to 74, 87, 88, 100, 101, 111 to 114, 135	12	2d to 4th	.0368	140
2439	"	76 to 83, 85, 86	0	2d, 3d	.0268	180
2439	"	116, 117	"	"	.0268	180
2439	"	116, 117	3/0	"	.0268	180
2044	"	133, 136	5/0	1st, 2d	.0208	220
2044	"	96, 97	10/0	1st	.0208	220
898	" Setting	65, 121, 122, 124	18	7th, 11th	.0488	140
916	"	1 to 6, 61, 62, 103, 105, 118, 119, 123	"	2d to 4th, 10th	.0368	140
1608	"	7 to 11, 120	"	5th, 7th, 11th	.0488	140
1748	"	63, 64, 104, 106	"	5th	.0608	110
2287	"	65, 66	"	7th	.0488	140

SCREWS, USE AND NUMBER—Continued

Catalogue No.	ARTICLE	CLASS	DESCRIPTION OF MOVEMENT		Diam. Tap	Threads Per In.
			Size	Model		
898	Lever, Setting	12 to 14	18	6th	.0488	140
898	"	89 to 91, 99, 130, 131, 134	"	8th, 9th	.0488	140
916	"	15	17	2d	.0368	140
913	"	16 to 23	16	1st, 2d	.0248	220
1601	"	32 to 41, 92 to 95, 107 to 110	"	6th, 7th	.0368	140
898	"	98, 102, 125 to 127, 132	"	8th, 9th, 13th to 15th, 17th	.0488	140
1722	"	98	"	13th	.0368	140
2909	"	128, 129	14	2d	.0368	140
1722	"	67 to 74, 87, 88, 100, 101, 111 to 114, 132	12	2d to 4th	.0368	140
916	"	49 to 52	6	1st	.0368	140
1609	"	53 to 56	"	2d	.0248	220
2445	"	115	"	"	.0248	220
1609	"	57 to 60	0	1st	.0248	220
2015	"	76 to 83, 85, 86, 116, 117	"	2d, 3d	.0268	180
2015	"	116, 117	3/0	"	.0268	180
2044	"	133, 136	5/0	1st, 2d	.0208	220
2044	"	96, 97	10/0	1st	.0208	220
34	Main	1 to 4, 119	18	2d to 4th, 10th	.0892	80
54	"	4, 5, 118	"	"	.0892	80
63	"	5, 6, 10, 11, 61 to 64, 103 to 106, 123	"	2d to 5th	.0892	80
184	"	7 to 9, 65, 66, 120 to 122, 124	"	5th, 7th, 11th	.0892	80
2041	"	89 to 91, 99, 130, 131, 134	"	8th, 9th	.0892	80
54	"	15	17	2d	.0892	80
63	"	24 to 31	16	3d to 5th	.0892	80
1610	"	32 to 41, 92 to 95, 98, 102, 107 to 110, 125, 127	"	"	.0608	110
2291	"	32, 36, 37, 41, 98, 102, 126, 132	"	6th to 9th, 13th, 8th, 7th, 9th, 13th to 15th, 17th	.0608	110
2610	"	128, 129	14	2d	.0608	110
2007	"	67 to 74, 87, 88, 100, 101, 111 to 114	12	2d, 3d	.0608	110
2618	"	135	"	4th	.0608	110
105	"	49 to 51	6	1st	.0772	80
151	"	52	"	"	.0772	80
1611	"	53 to 56	"	2d	.0608	110
2295	"	56, 75, 115	0	"	.0772	80
920	"	57 to 60, 84	0	1st	.0768	110
2010	"	76 to 83, 85, 86, 116, 117	"	2d, 3d	.0508	110
2010	"	116, 117	3/0	"	.0508	110
2032	"	133, 136	5/0	1st, 2d	.0408	120
2032	"	96, 97	10/0	1st	.0408	120
921	Pillar	1 to 11, 61 to 66, 103, to 106, 118 to 124	18	1st to 5th, 7th, 10th, 11th	.0468	110
1612	" Under Cock	7 to 11, 63 to 66, 104, 106, 120 to 122, 124	"	"	.0468	110
921	"	15	17	1st, 2d	.0468	110
1613	"	42, 43	14	1st	.0428	120
1614	"	44, 45	12	"	.0428	120
1614	"	46 to 48	10	"	.0428	120
1585	Phase Top	12 to 14	18	6th	.0428	120
2035	"	89 to 91, 99, 130, 131, 134	"	8th, 9th	.0428	120
1585	"	16 to 31	16	1st to 5th	.0428	120
1584	"	32 to 41, 92 to 95, 98, 102, 107 to 110, 125 to 127, 132	"	6th to 9th, 13th to 15th, 17th	.0428	120
2612	"	128, 129	14	2d	.0428	120
1999	"	67 to 74, 87, 88, 100, 101, 111 to 114	12	2d, 3d	.0428	120
2614	"	135	"	4th	.0428	120
935	"	49 to 56, 75, 115	6	1st, 2d	.0428	120
899	"	57 to 60, 84	0	1st	.0428	120
2012	"	76 to 83, 85, 86, 116, 117	"	2d, 3d	.0368	140
2012	"	116, 117	3/0	"	.0368	140
2030	"	133, 136	5/0	1st, 2d	.0308	180
2030	"	97, 97	10/0	1st	.0308	180
922	Potance	1 to 11, 65, 66, 118 to 122	18	1st to 5th, 7th, 10th, 11th	.0428	120
2510	Regulator, Adjusting	118 to 121	"	10th, 11th	.0368	140
923	"	24 to 26, 29 to 31	16	3d, 5th	.0228	260
2620	Ring, Extension	113, 114	12	2d, 3d	.0428	120
924	Shipper, Setting	12 to 14	18	6th	.0288	220
924	"	16 to 23	16	1st, 2d	.0288	220
925	Spring, Arm, Vibrating	4 to 6, 61, 62, 103, 105, 118, 123	18	2d to 4th, 10th	.0248	220
913	"	7 to 11, 65, 66, 120 to 122, 124	"	5th, 7th, 11th	.0248	220
925	"	24 to 28	16	3d, 4th	.0248	220
913	"	29 to 31	"	5th	.0248	220
910	"	49 to 51	6	1st	.0248	220
934	"	52	"	"	.0248	220
1615	"	53 to 56	"	2d	.0248	220
1995	"	75, 115	"	"	.0248	220
926	"	57 to 60	0	1st	.0248	220
1995	"	84	"	"	.0248	220
898	" Cam	7 to 11, 120	18	5th, 11th	.0488	140
896	"	12 to 14	"	6th	.0368	140
910	" Click	1 to 11, 61 to 66, 103 to 106, 118 to 124	"	1st to 5th, 7th, 10th, 11th	.0248	220
910	"	12 to 14	"	6th	.0248	220
1615	"	89 to 91, 99, 130, 131, 134	"	8th, 9th	.0248	220
910	"	15	17	1st, 2d	.0248	220
904	"	16 to 23	16	"	.0248	220

SCREWS, USE AND NUMBER—Continued

Catalogue No.	ARTICLE	CLASS	DESCRIPTION OF MOVEMENT		Diam. Tap	Threads Per In.
			Size	Model		
913	Spring, Click	24 to 31	16	3d to 5th	.0248	220
1615	"	32 to 41, 92 to 95, 98, 102, 107 to 110, 125 to 127, 132	"	6th to 9th, 13th to 15th, 17th	.0248	220
904	"	42, 43	14	1st	.0248	220
2004	"	128, 129	"	2d	.0208	220
2004	"	67 to 74, 87, 88, 100, 101, 111 to 114, 135	12	2d to 4th	.0208	220
928	"	49 to 56, 75, 115	6	1st, 2d	.0248	220
1617	"	57 to 60, 84	0	1st	.0248	220
2021	"	76 to 83, 85, 86, 116, 117	0	2d, 3d	.0168	260
2021	"	116, 117	3/0	"	.0168	260
2046	"	133, 136	5/0	1st, 2d	.0168	260
2046	"	96, 97	10/0	1st	.0168	260
913	Drag	27, 28	16	4th	.0248	220
1615	Lever, Clutch	89 to 91, 99, 130, 131, 134	18	8th, 9th	.0248	220
1615	"	32 to 41	16	6th, 7th	.0248	220
2004	"	98, 102, 125 to 127, 132	"	8th, 9th, 13th to 15th, 17th	.0208	220
910	Setting	4 to 8, 61, 62, 103, 105, 118, 123	18	2d to 4th, 10th	.0248	220
1603	"	65, 66, 121, 122, 124	"	7th, 11th	.0248	220
1603	"	89 to 91, 99, 130, 131, 134	"	8th, 9th	.0248	220
916	"	12 to 14	"	6th	.0368	140
922	"	16 to 28	16	1st to 4th	.0428	120
1603	"	98, 102, 125 to 127, 132	"	8th, 9th, 13th to 15th, 17th	.0248	220
904	"	53 to 56	6	2d	.0248	220
926	"	57 to 60	0	1st	.0248	220
2509	Regulator	118 to 121	18	10th, 11th	.0248	220
913	"	24 to 26, 29 to 31	16	3d, 5th	.0248	220
910	Setting	1 to 5, 118, 119	18	2d to 4th, 10th	.0248	220
913	"	7 to 11	"	5th	.0248	220
928	"	7 to 11, 63 to 66, 104, 106, 120 to 122, 124	"	5th, 7th, 11th	.0248	220
932	"	12 to 14	"	6th	.0368	140
932	"	16 to 23	16	1st, 2d	.0368	140
1617	"	24 to 28	"	3d, 4th	.0248	220
898	"	29 to 31	"	5th	.0488	140
1618	"	32 to 41, 92 to 95, 107 to 110	"	6th, 7th	.0368	140
2001	"	128, 129	14	2d	.0428	120
2656	"	128, 129	"	"	.0428	120
2001	"	67 to 74, 87, 88, 100, 101, 111 to 114, 135	12	2d to 4th	.0428	120
910	"	49 to 52	6	1st	.0248	220
904	"	53 to 56, 75, 115	"	2d	.0248	220
926	"	57 to 60, 84	0	1st	.0248	220
2014	"	76 to 83, 85, 86, 116, 117	"	2d, 3d	.0368	140
2014	"	116, 117	3/0	"	.0368	140
2047	"	133, 136	5/0	1st, 2d	.0208	220
2047	"	96, 97	10/0	1st	.0208	220
2611	Stop, Setting Cam	128	14	2d	.0608	110
2607	"	128, 129	"	"	.0608	110
2607	"	111 to 114	12	2d, 3d	.0608	110
1721	"	87, 88, 100, 101, 111 to 114	"	"	.0368	220
913	Lever	1 to 4, 119	18	2d to 4th, 10th	.0248	220
1734	"	75, 115	6	2d	.0368	220
2623	"	75, 115	"	"	.0608	110
1734	"	84	0	1st	.0368	220
934	Stud, Hair Spring	1 to 11, 65, 66, 103 to 106, 118 to 124	18	1st to 5th, 7th, 10th, 11th	.0248	220
934	"	12 to 14	"	6th	.0248	220
934	"	89 to 91, 99, 130, 131, 134	"	8th, 9th	.0248	220
1619	"	6, 11, 61 to 64	"	2d to 5th	.0208	220
934	"	16 to 41, 92 to 95, 98, 102, 107 to 110, 125 to 127, 132	18	1st to 9th, 13th to 15th	.0248	220
934	"	42, 43	14	1st	.0248	220
1620	"	128, 129	"	2d	.0208	220
934	"	44, 45	12	1st	.0248	220
1620	"	67 to 74, 87, 88, 100, 101, 111 to 114, 135	"	2d, 3d	.0208	220
2832	"	135	"	4th	.0168	260
934	"	46 to 48	10	1st	.0248	220
1620	"	49 to 56, 75, 115	6	1st, 2d	.0208	220
1621	"	57 to 60, 76 to 86, 116, 117	0	1st to 3d	.0208	220
1621	"	116, 117	3/0	2d, 3d	.0208	220
2442	"	133, 136	5/0	1st, 2d	.0168	260
2442	"	96, 97	10/0	1st	.0168	260
2624	Wheel Ratchet	130, 131, 134	18	8th, 9th	.0488	140
1601	"	32 to 41, 92 to 95, 98, 107 to 110, 127	16	6th, 7th, 9th, 15th	.0368	140
2026	"	33, 34, 36, 38, 39, 41, 98, 102, 125	"	6th to 9th, 13th, 15th	.0368	140
2292	"	32, 37	"	6th, 7th	.0368	140
2613	"	128, 129	14	2d	.0368	140
1722	"	87, 88, 100, 101, 111 to 114	12	2d, 3d	.0368	140
2613	"	111 to 114	"	"	.0368	140
2619	"	135	"	4th	.0488	140
1722	"	77, 81, 85, 86, 116, 117	0	2d, 3d	.0368	140
2613	"	116, 117	"	"	.0368	140
2613	"	116, 117	3/0	"	.0368	140
2033	"	133, 136	5/0	1st, 2d	.0308	220
2033	"	96, 97	10/0	1st	.0308	220
936	Setting	52	6	"	.0248	220
937	Inter Winding	29 to 31	16	5th	.0708	180

PRICE OF SCREWS

A—Flat Head, Bright, Edge and Slot Cornered.
 C—Flat Head, Bright.
 D—Flat Head, Blue.

E—Flat Head, Gray.
 G—Bevel Head, Bright.
 H—Bevel Head, Blue.

Catalogue No.	A	C-D-E	G-H	Catalogue No.	A	C-D-E	G-H	Catalogue No.	A	C-D-E	G-H
	Doz.	Doz.	Doz.		Doz.	Doz.	Doz.		Doz.	Doz.	Doz.
24		.75		1599		.20		2045	.50	.20	
34		.25		1600		.20		2046		.20	
43		.25		1601	.50	.20		2047		.20	
105		.25		1603	.50	.20	.25	2048	.30	.20	.25
151		.25		1604	.50	.20	.25	2049		.20	.25
184		.25		1606	.50	.20	.25	2051			.20
885		.20		1607		.20		2282	.75		.65
886	.85		.75	1608		.20		2284	.75		.65
887			.20	1609		.20		2285			.65
888			.20	1610	.60	.25		2286	.50	.20	.25
889			.75	1611		.25		2287		.20	
890			.20	1612		.25		2289		.20	
891		.20		1613			.30	2291	.60		
892		.20		1614			.30	2292	.50		
893	.60	.25	.30	1615		.20		2293	.50	.20	.25
894	.50	.20		1617		.20		2294		.20	.25
895		.20		1618		.20		2295		.25	
896		.20	.25	1619		.20	.25	2298		.20	
897		.20	.25	1620	.50	.20	.25	2300			.20
898		.20		1621	.50	.20	.25	2301			.20
899	.60	.25	.30	1721		.20		2302			.20
901		.20		1722	.50	.20		2303			.20
902		.20		1734		.20		2304			.20
903	.60	.25	.25	1747		.25		2305			.20
904	.50	.20	.25	1748		.20		2306			.20
906		.20	.25	1749		.25		2306		.75	
907		.20	.25	1904		.20		2429		.75	
908	.60	.25	.30	1995		.20		2430		.75	
909		.20	.25	1996		.20		2431		.75	
910	.50	.20	.25	1997		.20		2438		.20	
911		.20		1998	.60	.25	.25	2439		.20	
912	.50	.20	.25	1999	.60	.25	.30	2440		.20	
913	.50	.20	.25	2000	.50	.20		2441	.50	.20	.25
914		.20	.25	2001		.20		2442		.20	
916		.20	.25	2002		.20		2443		.20	
920		.25	.30	2003	.50	.20		2444	.60	.25	.30
921	.60	.25	.30	2004		.20		2445		.20	
922		.20	.25	2005		.20		2509		.20	
923		.20	.75	2006	.50	.20	.25	2510	.75		
924	.50	.20	.25	2007	.60	.25		2519			.20
925		.20		2008	.50	.25	.25	2520			.75
926		.20		2009	.50	.25	.25	2531			.25
928	.50	.20		2010	.60	.25		2607		.20	
932	.50		.25	2011	.50	.20	.25	2608		.20	
934	.50	.20	.25	2012	.60	.25	.30	2609		.20	
935	.60	.25	.30	2013	.50	.20		2610	.60	.25	
936		.20		2014		.20		2611		.20	
937		.20		2015		.20		2612	.60	.25	.30
1568			.20	2016	.50	.20		2613	.50	.20	.30
1569			.20	2017	.50	.20	.25	2614	.60	.25	.20
1570	.75		.65	2018		.20		2616		.25	
1571	.75		.65	2019		.20		2618	.60	.20	
1574			.20	2020	.50	.20	.25	2619	.50	.20	.25
1575			.20	2021		.20		2620	.50	.20	.25
1576			.20	2022		.20	.20	2623		.20	
1577			.20	2023	.50	.20	.25	2624	.60	.20	
1578			.20	2024	.50	.20	.25	2625	.50	.20	
1579	.85		.75	2025		.20		2630	.60	.25	.25
1582			.20	2026	.50	.20		2656		.20	
1583	.60	.25	.30	2027			.20	2658			.20
1584	.60	.25	.30	2029	.60	.25	.25	2728			.20
1585	.60	.25	.30	2030	.60	.25	.25	2730		.75	
1586		.20		2031		.20		2822		.20	
1587		.20		2032	.60	.25		2824	.60		.25
1588		.20		2033	.50	.20		2832			.20
1589		.25		2034	.60	.25	.25	2833			.25
1590	.60	.25	.25	2035	.60	.25	.30	2836			.20
1591	.60	.25	.25	2036	.60	.25	.30	2837			.20
1592		.25	.25	2037	.50	.20		2838			.20
1594	.60	.25	.25	2038		.20		2911		.20	
1595	.60	.25	.25	2039		.20		2957	.60	.25	.25
1596	.60	.25	.30	2041	.60	.25		2979		.20	
1597			.30	2042	.85		.75	2982		.20	.25
1598			.30	2044		.20					

LARGE SIZE SCREWS.

It sometimes happens where screws have to be removed and replaced a number of times, the thread in plate becomes worn so that the screws overturn; to take care of such instances we make screws that are slightly larger than regular size which are known as Large. These will be supplied at the same price as standard screws. In ordering specify "Large" in addition to catalogue number and letter.

EXTRA LARGE SIZE SCREWS.

For use in instances where the thread has been entirely stripped from plate we make Extra Large Size screws. Before using these screws it is necessary to retap the stripped hole. In ordering specify "Extra Large" in addition to catalogue number and letter.

Taps for "Extra Large Size" screws will be supplied at 10 cents each or \$1.00 per dozen.

GOLD PLATED SCREWS.

We can supply Gold Plated Steel screws in A, C or G quality at 10 cents per dozen additional to list price. In ordering specify Gold Plated in addition to number and letter.

ASSORTED SCREWS.

For assorted screws see page No. 132.

TIMING SCREWS.

For the benefit of watchmakers who are called on to replace Breguet hair springs in our movements and who find difficulty in bringing them "to time" within the limits of the regulator, owing to the new spring being too strong or weak, as the case may be, we are putting up assortments of Timing Screws for this purpose, which we believe will prove of great assistance to the trade in quickly correcting the error—by the addition or substitution of a pair of these screws.

Each assortment of composition screws contains fifty pairs, while an assortment of gold has twenty-five pairs, consisting of six different weights or values suitable for movements of one size, the various weights being placed in separate boxes, properly labeled, giving the effect a pair should have on the balance for each hour run. These six boxes are enclosed in a larger one, thus making a very convenient package. See page 132 for description and prices.

INSTRUCTIONS FOR USING TIMING SCREWS

If, on placing the regulator in the center of the index, it is found, on running the movement one hour, that it gains a certain number of seconds, then a pair of timing screws should be selected of suitable weight or value to overcome the error and placed in the balance *directly opposite one another*. This should bring the movement to time or within the limits of the regulator.

On again running the movement, if it is found that it loses, then remove a pair of the regular or full size balance screws from the balance (being careful that they be taken from positions *directly opposite each other*) and run the movement with the balance in this condition, when it will undoubtedly be found that it gains; in which case, by again selecting a pair of timing screws of the desired weight to correct such condition and placing them in the balance, in the same position from which the pair were removed, no difficulty should be had in correcting any slight error which may now appear, by the aid of the regulator. *After changes are made see that the balance is poised.*

WATCH SCREW TAPS

The table below gives all of the standard taps used in connection with the screws listed on the preceding pages. The diameter in thousandths of an inch and number of threads per inch are marked on the handle of each tap as shown in the illustration.

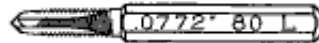

(Twice actual size)

PRICE OF TAPS

The Complete Set of 27 **2.00**
 Per Dozen of one Kind or Assorted **1.00**
 Less than 1/4 Dozen, each **.10**

Catalogue Number	TAP — DIAMETER		Threads per Inch	DRILL — DIAMETER	
	Inches	Millimeters		Inches	Millimeters
4000	.0132	.33	300	.0112	.28
4001	.0148	.37	320	.0120	.30
2374	.0168	.42	260	.0132	.33
2375	.0208	.52	220	.0168	.42
2490	.0228	.57	260	.0188	.47
2491	.0248	.62	220	.0200	.50
2492	.0268	.67	180	.0220	.55
4002	.0288	.72	220	.0248	.62
2493	.0308	.77	180	.0248	.62
4003	.0308	.77	220	.0268	.67
2494	.0368	.92	140	.0280	.70
2495	.0368	.92	220	.0268	.67
2496L	.0408	1.02	120L	.0300	.75
2497	.0408	1.02	200	.0348	.87
2498	.0428	1.07	120	.0328	.82
4004	.0448	1.12	110	.0340	.85
2499	.0468	1.17	110	.0348	.87
2500	.0488	1.22	140	.0400	1.00
2501	.0488	1.22	200	.0436	1.09
2502L	.0508	1.27	110L	.0388	.97
2503	.0548	1.37	180	.0488	1.22
2504	.0608	1.52	110	.0488	1.22
2505L	.0608	1.52	110L	.0488	1.22
4005L	.0708	1.77	180L	.0648	1.62
2506L	.0768	1.92	110L	.0708	1.77
2507L	.0772	1.93	80L	.0612	1.53
2508L	.0892	2.23	80L	.0712	1.78

Observe that several different numbers of screws are the same as relates the diameter and number of threads per inch, thus requiring a comparatively small number of taps to embody the entire line. "L" affixed to a tap number indicates a left-hand thread.

PENDANT TAPS

Per Set of Six **1.25**
 Less than 1/4 Dozen, each **.25**
 Per Dozen of one Kind or Assorted **2.50**

SIZE	TAP — DIAMETER		Threads per Inch	DRILL — DIAMETER	
	Inches	Millimeters		Inches	Millimeters
18	.236	5.90	50	.211	5.28
16	.200	5.00	60	.180	4.50
12-6	.176	4.40	66	.158	3.95
0	.156	3.90	66	.138	3.45
5/0	.128	3.20	80	.114	2.85
10/0	.103	2.58	90	.086	2.15

CROWN TAPS

Per Set of Four **.50**
 Less than 1/4 Dozen, each **.15**
 Per Dozen of one Kind or Assorted **1.50**

SIZE	TAP — DIAMETER		Threads per Inch	DRILL — DIAMETER	
	Inches	Millimeters		Inches	Millimeters
18	.091	2.28	60	.071	1.78
16	.077	1.93	72	.063	1.58
12-6-0	.061	1.53	80	.048	1.20
5/0-10/0	.048	1.20	110	.038	.95

To aid watchmakers in selecting drills the diameter in inches and millimeters of drills suitable for the taps are given. We do not, however, manufacture drills for sale.

SLEEVES, WINDING ARBOR

Catalogue No.	CLASS	PRICE		DESCRIPTION OF MOVEMENT		
		Piece	Per Doz.	Size	Model	
1912	32, 36, 37, 41	.30	3.00	16	3/4 Pl.	6th, 7th
1912	33 to 35, 38 to 40	.25	2.50	"	"	"
1912	92 to 95, 107 to 110	.20	2.00	"	"	"
1913	128, 129	.20	2.00	14	"	2d
1913	67, 68, 71, 72	.30	3.00	12	"	2d, 3d
1913	69, 70, 74, 75	.25	2.50	"	"	"
1913	87, 88, 100, 101, 111 to 114	.20	2.00	"	"	"
2770	135	.30	3.00	"	"	4th
1914	76, 77, 80, 81	.30	3.00	0	"	2d, 3d
1914	78, 79, 82, 83	.25	2.50	"	"	"
1914	85, 86, 116, 117	.20	2.00	"	"	"
2657	133, 136	.25	2.50	5/0	"	1st, 2d
1915	96, 97	.25	2.50	10/0	"	1st

No. 1912	No. 1913	No. 1914	No. 1915	No. 2657	No. 2770
Htg. or O. F.	Htg. or O. F.	Htg. or O. F.	O. F.	Htg. or O. F.	O. F.

SPRINGS, VIBRATING ARM

Catalogue No.	CLASS	PRICE		DESCRIPTION OF MOVEMENT		
		Piece	Per Doz.	Size	Model	
61	4 to 6, 61, 62, 103, 105, 118, 123	.10	.50	18	F. Pl.	2d to 4th, 10th
183	7, 65	.10	1.00	"	"	5th, 7th
183	8, 9, 66	.10	.75	"	"	"
183	10, 11, 120 to 122, 124	.15	.50	"	"	5th, 7th, 11th
131	24 to 28	.10	.50	16	3/4 Pl.	3d, 4th
183	29, 30	.10	.75	"	"	5th
183	31	.10	.50	"	"	"
159	49 to 51	.10	.75	6	"	1st
61	52	.10	.50	"	"	"
1471	53 to 55	.10	.75	"	"	2d
1471	56	.10	.50	"	"	"
1755	75, 115	.10	.50	"	"	"
765	57 to 59	.10	.75	0	"	1st
765	60	.10	.50	"	"	"
1729	84	.10	.50	"	"	"

No. 61	No. 131	No. 159	No. 183	No. 765	No. 1471	No. 1729	No. 1755
Htg.	Htg. or O. F.	Htg.	O. F.	Htg.	Htg.	Htg.	Htg.

















SPRINGS, CAM

Catalogue No.	CLASS	PRICE		DESCRIPTION OF MOVEMENT		
		Piece	Per Doz.	Size	Model	
173	7 to 9	.15	1.50	18	F. Pl.	5th
173	10, 11, 120	.19	1.00	"	"	5th, 7th
160	12 to 14	.10	1.00	"	3/4 Pl.	6th

No. 160	No. 173
Htg. or O. F.	O. F.

SPRINGS, CLICK

Catalogue No.	CLASS	PRICE		DESCRIPTION OF MOVEMENT	
		Piece	Per Doz.	Size	Model
766	1.....	.10	1.00	18	F. Pl. 1st
766	2 to 4.....	.10	.75	"	" " "
766	5.....	.10	.50	"	" " "
767	6.....	.10	.50	"	" " "
112	1, 7, 65.....	.10	1.00	"	" " 2d to 5th, 7th
112	2 to 4, 8, 9, 66.....	.10	.75	"	" " "
112	5, 6, 10, 11, 61 to 64, 103 to 106.....	.10	.50	"	" " 2d to 5th
1895	1, 7, 65.....	.10	1.00	"	" " 2d to 5th, 7th
1895	119, 121, 122.....	.10	.50	"	" " 7th, 10th, 11th
2355	4, 9.....	.10	.75	"	" " 2d to 5th
2355	62, 64, 103 to 106, 118, 120, 123, 124.....	.10	.50	"	" " 2d to 5th, 7th, 10th, 11th
89	12 to 14.....	.10	1.00	"	" " $\frac{3}{4}$ Pl. 6th
1896	89 to 91, 99.....	.10	1.00	"	" " 8th, 9th
1896	134.....	.10	.75	"	" " 8th
1896	130, 131.....	.10	.50	"	" " 8th, 9th
767	15.....	.10	.50	17	F. Pl. 1st
74	15.....	.10	.50	"	" " 2d
89	16, 21.....	.15	1.50	16	$\frac{3}{4}$ Pl. 1st, 2d
89	17 to 20, 22, 23.....	.10	1.00	"	" " "
128	24, 25, 27 to 30.....	.10	.75	"	" " 3d to 5th
128	26, 31.....	.10	.50	"	" " 3d, 5th
1896	32, 36, 37, 41, 98, 126, 132.....	.10	1.00	"	" " 6th, 7th, 9th, 13th to 15th
1896	33, 34, 38, 39, 102, 125.....	.10	.75	"	" " 17th
1896	35, 40, 92 to 95, 107 to 110, 127.....	.10	.50	"	" " 6th to 9th, 13th, 15th
1472	32, 36, 37, 41.....	.10	1.00	"	" " 6th, 7th, 9th
1472	33, 34, 38, 39.....	.10	.75	"	" " 6th, 7th
1472	35, 40, 92, 94.....	.10	.50	"	" " "
774	42, 43.....	.10	.75	14	" " 1st
1897	128, 129.....	.10	.50	"	" " 2d
775	44, 45.....	.10	1.00	12	" " 1st
1897	67, 68, 71, 72, 135.....	.10	1.00	"	" " 2d to 4th
1897	69, 73.....	.10	.75	"	" " 2d, 3d
1897	70, 74, 87, 88, 100, 101, 111 to 114.....	.10	.50	"	" " "
775	46 to 48.....	.10	1.00	10	" " 1st
103	49 to 51, 53 to 55.....	.10	.75	6	" " 1st, 2d
103	52, 56, 75, 115.....	.10	.50	"	" " "
776	57 to 59.....	.10	.75	0	" " 1st
776	60, 84.....	.10	.50	"	" " "
1898	76, 77, 80, 81.....	.10	.75	"	" " 2d, 3d
1898	78, 79, 82, 83, 85, 86, 116, 117.....	.10	.50	"	" " "
1899	133, 136.....	.10	.75	5/0	" " 1st, 2d
1899	96.....	.10	1.00	10/0	" " 1st
1899	97.....	.10	.75	"	" " "

No. 74  Htg.	No. 89  Htg. or O. F.	No. 103 ✓  Htg.	No. 112  Htg. or O. F.	No. 128  Htg. or O. F.	No. 766  Htg.
No. 767  Htg.	No. 774  Htg.	No. 775  Htg.	No. 776  Htg.	No. 1472  Htg. or O. F.	No. 1895  Htg. or O. F.
No. 1896  Htg. or O. F.	No. 1897  Htg. or O. F.	No. 1898  Htg. or O. F.	No. 1899  Htg. or O. F.	No. 2355  Htg. or O. F.	

Your Jobber will supply Balance Staffs, Balance Jewels, Hands and Screws in Dozen lots in original sealed Trade Marked packages.

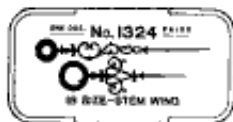

[TOP]

TRADE-MARKED PACKAGE



[BOTTOM]

SPRINGS, CLUTCH LEVER

Catalogue No.	CLASS	PRICE		DESCRIPTION OF MOVEMENT	
		Piece	Per Doz.	Size	Model
1894	89 to 91, 99	.10	1.00	18	3/4 Pl. 8th, 9th
1894	134	.10	.75	"	" 8th
1894	130, 131	.10	.50	"	" 8th, 9th
1476	32, 36, 37, 41	.10	1.00	16	" 6th, 7th
1476	33, 34, 38, 39	.10	.75	"	" "
1476	35, 40	.10	.50	"	" "
2152	98, 126, 132	.10	1.00	"	" 9th, 13th, 15th, 17th
2152	102	.10	.75	"	" 13th, 15th
2152	127	.10	.50	"	" 9th
2547	126	.10	1.00	"	" 14th
2547	125	.10	.75	"	" 8th

No. 1476



Htg. or O. F.

No. 1894



Htg. or O. F.

No. 2152



O. F.

No. 2547



Htg.

SPRINGS, SETTING LEVER

Catalogue No.	CLASS	PRICE		DESCRIPTION OF MOVEMENT	
		Piece	Per Doz.	Size	Model
53	4, 5	.10	.75	18	F. Pl. 2d to 4th
53	6, 61, 62, 103, 105, 118, 123	.10	.50	"	" 2d to 4th, 10th
1900	65	.10	1.00	"	" 7th
1900	66	.10	.75	"	" "
1900	121, 122, 124	.10	.50	"	" 7th, 11th
164	12 to 14	.10	1.00	"	" 6th
1900	89 to 91, 99	.10	1.00	"	3/4 Pl. 8th, 9th
1900	134	.10	.75	"	" 8th
1900	130, 131	.10	.50	"	" 8th, 9th
90	16 to 23	.10	.50	16	" 1st, 2d
130	24 to 28	.10	.50	"	" 3d, 4th
2153	98, 132	.10	1.00	"	" 9th, 13th, 15th
2153	102, 109	.10	.75	"	" 6th, 9th, 13th, 15th
2153	127	.10	.50	"	" 9th
2546	126	.10	1.00	"	" 14th
2546	125	.10	.75	"	" 8th
2797	120	.10	1.00	"	" 17th
1258	53 to 55	.10	1.00	6	" 2d
1258	56	.10	.75	"	" "
811	57 to 59	.10	1.00	0	" 1st
811	60	.10	.75	"	" "

No. 53



Htg.

No. 90



Htg. or O. F.

No. 130



Htg. or O. F.

No. 164



Htg. or O. F.

No. 811



Htg.

No. 1258



Htg.

No. 1900



Htg. or O. F.

No. 2153



O. F.

No. 2546



Htg.

No. 2797



Htg.

Your Jobber will supply Balance Staffs, Balance Jewels, Roller Jewels, Hands and Screws in Dozen lots in original Sealed Trade Marked packages.

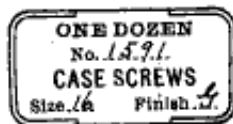

[TOP]















TRADE-MARKED PACKAGE



[BOTTOM]

SPRINGS, HAIR—COLLETED

Catalogue No.	Strength	PRICE		Price of Spring and Vibrating	Size	DESCRIPTION OF MOVEMENT		
		Piece	Per Doz.			Model		
792	1, 2	.15	1.50	.30	18	F. Pl.	1st to 5th	Flat
793	1, 2	.15	1.50	.30	"	"	1st to 4th	"
791	1, 2, 3, 4	.40	4.00	.60	"	"	1st to 5th, 7th	Breguet
2692	1	.40	4.00	.60	"	"	2d to 4th, 7th	"
2522	2	.40	4.00	.60	"	"	10th, 11th	"
2523	1	.40	4.00	.60	"	"	"	"
797	1, 2	.15	1.50	.30	"	3/4 PL	6th	Flat
1958	1	.40	4.00	.60	"	"	8th, 9th	Breguet
2693	1, 2	.40	4.00	.60	"	"	"	"
794	1, 2	.15	1.50	.30	17	F. Pl.	1st, 2d	Flat
797	1, 2	.15	1.50	.30	16	3/4 PL	1st to 5th	"
796	1, 2, 3, 4, 5, 6	.40	4.00	.60	"	"	1st to 3d, 5th to 9th, 13th to 15th, 17th	Breguet
803	1, 2	.15	1.50	.30	14	"	1st	Flat
1959	1, 2, 2 1/2, 3, 3 1/2	.40	4.00	.60	"	"	2d	Breguet
804	1, 2	.15	1.50	.30	12	"	1st	Flat
1959	1, 2, 2 1/2, 3, 3 1/2	.40	4.00	.60	"	"	2d, 3d	Breguet
2801	1, 2	.40	4.00	.60	"	"	4th	"
804	1, 2	.15	1.50	.30	10	"	1st	Flat
806	1, 2, 2 1/2	.15	1.50	.30	6	"	1st, 2d	"
805	1, 2, 3, 4, 5, 6	.40	4.00	.60	"	"	"	Breguet
808	1, 2	.15	1.50	.30	6	"	1st	Flat
807	1, 2, 3, 4, 5, 6, 7, 8	.40	4.00	.60	"	"	1st to 3d	Breguet
2694	1, 2	.40	4.00	.60	5/0	"	1st, 2d	"
1960	1, 2	.40	4.00	.60	10/0	"	1st	"

No. 791, 2692, 2693  Htg. or O. F.	No. 792, 793, 794  Htg. or O. F.	No. 796  Htg. or O. F.	No. 797  Htg. or O. F.	No. 803, 804, 806  Htg.
No. 805  Htg.	No. 807  Htg. or O. F.	No. 2694  Htg. or O. F.	No. 808  Htg.	No. 1958  Htg. or O. F.
No. 1959  Htg. or O. F.	No. 1960  O. F.	No. 2522, 2523  Htg. or O. F.	No. 2801  O. F.	

* Slow train.

Your Jobber will supply Hair Springs done up separately in trade marked papers, printed with Strength and Number as shown by illustration below.



IMPORTANT

We particularly call your attention to Hair Spring notes on page 101.

In ordering Hair Springs be sure and specify Number and Strength.

The table on the following pages will be found very convenient for selecting Number and Strength of spring for most grades.

Flat Hair Springs are not supplied with studs fitted.

SPRINGS, HAIR, BREGUET.

Table below gives Grades with Number and Strength of Spring Required.

Grade	Size	Model	Catalogue No.	Strength	Grade	Size	Model	Catalogue No.	Strength		
144	18	F. Pl.	2d to 4th	791	2	244	16	3/4 Pl.	7th	796	3
148	"	"	5th	791	2	245	"	"	"	796	3
149	"	"	2d to 4th	791	1 and 2	246	"	"	"	796	2
150	"	"	5th	791	1 and 2	247	"	"	8th	796	3
152	16	3/4 Pl.	6th	796	4	248	"	"	7th	796	3
153	"	"	"	796	4	249	18	F. Pl.	2d to 4th	791	2
154	"	"	"	796	4	250	"	"	5th	791	2
155	"	"	"	796	2	251	"	"	2d to 4th	791	2
156	"	"	"	796	2	252	"	"	7th	791	1
158	"	"	7th	796	4	253	12	3/4 Pl.	2d	1959	3
159	"	"	"	796	4	254	"	"	3d	1959	3
160	"	"	"	796	3	255	10/0	"	1st	1960	2
161	"	"	"	796	2	256	"	"	"	1960	1
162	"	"	"	796	2	257	16	"	6th	796	3
167	0	"	1st	807	5	258	"	"	7th	796	3
168	6	"	2d	805	1	259	12	"	2d	1959	3
174	0	"	1st	807	0	260	"	"	3d	1959	3
176	6	"	2d	805	2	261	18	F. Pl.	2d to 4th	791	2
180	18	F. Pl.	7th	791	1 and 2	262	"	"	5th	791	2
181	"	"	"	791	1 and 2	263	0	3/4 Pl.	2d	807	2
182	16	3/4 Pl.	5th	796	3	264	"	"	3d	807	2
183	18	F. Pl.	2d to 4th	791	1 and 2	265	18	F. Pl.	7th	791	2
184	"	"	5th	791	1 and 2	266	"	"	"	791	2
185	10	3/4 Pl.	6th	796	3	267	0	3/4 Pl.	2d	807	3
186	"	"	7th	796	3	268	"	"	3d	807	3
187	12	"	2d	1959	2	269	"	"	2d	807	4
188	"	"	"	1959	2	270	16	"	9th	796	2
189	"	"	"	1959	1	271	0	"	1st	807	5
190	"	"	"	1959	1	272	6	"	2d	805	3
191	"	"	3d	1959	2	273	18	"	9th	1958	1
192	"	"	"	1959	2	274	12	"	2d	1959	3
193	"	"	"	1959	1	275	"	"	3d	1959	3
194	"	"	"	1959	1	276	18	F. Pl.	7th	791	1
196	"	"	2d	1959	2	277	"	"	2d to 4th	791	2
197	"	"	3d	1959	2	278	"	"	5th	791	2
198	0	"	2d	807	3	279	16	3/4 Pl.	9th	796	2
199	"	"	"	807	3	280	"	"	2d	807	4
200	"	"	"	807	3	281	0	"	3d	807	4
201	"	"	"	807	3	282	"	"	3d	807	4
202	"	"	3d	807	3	283	6	"	2d	805	5
203	"	"	"	807	3	284	18	F. Pl.	5th	791	2
204	"	"	"	807	3	285	"	3/4 Pl.	2d	805	3
205	"	"	"	807	3	286	0	F. Pl.	2d to 4th	791	2
206	6	"	2d	805	5	287	18	"	5th	791	2
207	18	F. Pl.	2d to 4th	791	3 and 4	288	"	3/4 Pl.	2d	805	3
208	"	"	5th	791	3 and 4	289	6	"	6th	796	3
209	6	3/4 Pl.	2d	805	5	290	16	"	7th	796	3
210	16	"	6th	796	5 and 6	291	"	"	6th	796	3
211	"	"	7th	796	5 and 6	292	"	"	7th	796	3
212	"	"	8th	796	5 and 6	293	18	F. Pl.	5th	791	2
213	"	"	7th	796	5 and 6	294	6	3/4 Pl.	2d	805	3
214	18	"	8th	1958	1	295	18	F. Pl.	2d to 4th	791	2
215	"	F. Pl.	5th	791	3 and 4	296	"	"	5th	791	2
216	6	3/4 Pl.	2d	805	5	297	0	3/4 Pl.	2d	807	3
217	18	F. Pl.	2d to 4th	791	3 and 4	298	16	"	6th	796	3
218	"	"	5th	791	3 and 4	299	"	"	7th	796	3
219	0	3/4 Pl.	1st	807	4	300	12	"	2d	1959	2
220	16	"	6th	796	5 and 6	301	"	"	"	1959	2
221	"	"	7th	796	5 and 6	302	"	"	3d	1959	2
222	0	"	1st	807	4	303	"	"	"	1959	2
223	"	"	"	807	4	304	16	"	6th	796	3
224	"	"	2d	807	4	305	"	"	7th	796	3
225	"	"	3d	807	4	306	18	F. Pl.	2d to 4th	791	2
226	18	F. Pl.	2d to 4th	791	2	307	"	"	5th	791	2
227	"	"	5th	791	2	308	"	"	2d to 4th	791	2
228	"	"	2d to 4th	791	2	309	12	3/4 Pl.	2d	1959	2
229	"	"	5th	791	2	310	"	"	3d	1959	2
230	6	3/4 Pl.	2d	805	3	311	16	"	6th	796	3
231	"	"	"	805	3	312	"	"	7th	796	3
232	12	"	"	1959	3	313	12	"	2d	1959	2
233	"	"	"	1959	3	314	"	"	3d	1959	2
234	"	"	3d	1959	3	315	18	F. Pl.	2d to 4th	791	2
235	"	"	"	1959	3	316	"	"	5th	791	2
236	"	"	2d	1959	1	317	0	3/4 Pl.	2d	807	3
237	"	"	3d	1959	1	318	"	"	3d	807	3
238	18	"	8th	1958	1	319	"	"	2d	807	3
240	"	"	"	1958	1	320	"	"	"	1959	2
241	16	"	6th	796	3	321	12	"	3d	1959	2
242	"	"	"	796	3	322	"	"	2d	807	3
243	"	"	"	796	2	323	0	"	3d	807	3
						324	"	"	2d	805	3
						325	6	"	2d		

SPRINGS, HAIR, BREGUET—Continued.

Grade	Size	Model	Catalogue No.	Strength	Grade	Size	Model	Catalogue No.	Strength		
326	18	Fl. Pl.	5th	791	2	372	16	3/4 Pl.	15th	796	2
327	"	"	10th	2522	2	373	"	"	14th	796	2
328	"	"	"	2522	2	374	"	"	15th	796	2
329	"	"	"	2523	1	375	"	"	"	796	2
330	"	"	"	2523	1	376	"	"	"	796	2
331	"	"	11th	2522	2	377	0	"	2d	807	3
332	"	"	"	2522	2	378	18	F. Pl.	2d to 4th	791	2
333	"	"	"	2523	1	379	"	"	5th	791	2
334	"	"	"	2523	1	380	5/0	3/4 Pl.	1st	2694	1
335	"	"	4th	791	2	381	16	"	6th	796	3
336	"	"	5th	791	2	382	"	"	7th	796	3
337	16	3/4 Pl.	6th	796	3	383	12	"	2d	1959	2
338	"	"	7th	796	3	384	"	"	3d	1959	2
339	"	"	8th	796	3	385	18	"	8th	2693	1
340	"	"	7th	796	3	386	16	"	6th	796	3
341	"	"	8th	796	2	387	"	"	7th	796	3
342	"	"	9th	796	3	388	"	"	15th	796	2
343	18	F. Pl.	7th	791	2	389	18	"	8th	2693	1
344	12	3/4 Pl.	2d	1959	2	390	"	"	"	1958	1
345	"	"	3d	1959	2	391	16	"	15th	796	2
346	"	"	2d	1959	2	392	12	"	4th	2801	1
347	"	"	3d	1959	2	393	"	"	2d	1959	2
348	18	F. Pl.	2d to 4th	2692	1	394	"	"	3d	1959	2
349	"	"	7th	2692	1	395	"	"	2d	1959	2
350	16	3/4 Pl.	13th	796	2	396	"	"	3d	1959	2
351	"	"	7th	796	2	397	16	"	6th	796	3
352	18	F. Pl.	2d to 4th	791	2	398	"	"	7th	796	3
353	"	"	7th	791	2	399	5/0	"	2d	2694	2
354	0	3/4 Pl.	2d	807	3	400	18	"	8th	2693	2
355	"	"	3d	807	3	401	16	"	17th	796	2
356	14	"	2d	1959	2	402	"	"	"	796	2
357	"	"	"	1959	2	403	5/0	"	1st	2694	2
358	"	"	"	1959	2	404	10/0	"	"	1960	2
359	"	"	"	1959	2	405	"	"	"	1960	1
360	16	"	13th	796	2	406	0	"	2d	807	3
361	"	"	"	796	2	407	12	"	4th	2801	2
363	12	"	2d	1959	2	408	5/0	"	1st	2694	2
364	"	"	3d	1959	2	409	0	"	3d	807	3
365	16	"	6th	796	3	410	"	"	"	807	3
366	"	"	7th	796	3	411	18	F. Pl.	5th	791	2
367	18	"	8th	1958	1	412	"	3/4 Pl.	8th	1958	1
368	"	"	9th	2693	2	413	3/0	"	2d	807	3
369	"	"	8th	2693	2	414	"	"	3d	807	3
370	16	"	15th	796	2	415	"	"	2d	807	3
371	"	"	14th	796	2	416	"	"	3d	807	3

IMPORTANT

Our system of classifying Hair Springs has been changed for the following reasons: We have at various times made changes in the several sizes of Balances which have altered their weight, and consequently the strengths of Hair Springs have been changed accordingly; so much so that the Balance which we originally used in our "Class 1" movements took the same strength spring as those we are now using in "Class 6" movements, and in order to assist the trade in procuring suitable Hair Springs, we have adopted the following system:

Taking as a standard the heaviest Balance we make of a given size we vibrate a suitable spring to it, which spring is known as Strength 1; for the next lighter Balance, of course taking a lighter spring, the strength is known as Strength 2. In each case the lowest strength number represents the strongest spring, and the highest number the weakest spring.



















Having abandoned "classes" as relates to Hair Springs, if the Number of Movement is given for which spring is wanted, it will be of assistance to us in selecting one of proper strength, although the only sure way of getting a suitable Breguet Hair Spring for any special movement is to send us the Balance, that we may vibrate a spring to it; this does not necessarily apply to Flat Springs, although better results would be obtained should these instructions be followed.

TIMING SCREWS

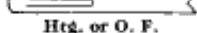
In case difficulty is experienced in bringing a new Hair Spring "to time" within the limits of the Regulator, owing to the spring's being too strong or weak (as the case may be), we are putting up assortments of Timing Screws for this purpose which will prove of great assistance in quickly correcting the error, by the addition or subtraction of a pair of these screws; a full description and instructions for their use will be found in its appropriate place under "Screws."

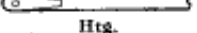
extra light, P103 SPRINGS, MAIN

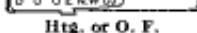
Size	Catalogue No.	Width in Thousandths of an Inch	Thickness in Thousandths of an Inch	Width in Millimeters	Thickness in Millimeters	Suitable for	Models used in
18	812	.115	.0085	2.92	.215	21 jewel	18 size full plate. Also 18 size $\frac{3}{4}$ plate having going barrels.
18	812	.115	.00875	2.92	.222	17 jewel	
18	812	.115	.009	2.92	.228	7 and 15 jewel	
18	2324	.115	.00875	2.92	.222	15 jewel	18 size full plate in some of the very old numbers.
18	2324	.115	.009	2.92	.228	7 jewel	
18	1956	.154	.00675	3.91	.171	23 jewel	18 size $\frac{3}{4}$ plate having steel safety barrels.
18	1956	.154	.007	3.91	.177	19 and 21 jewel	
18	817	.104	.008	2.64	.203	7 and 15 jewel	18 size 6th model.
17	816	.115	.0085	2.92	.215	7 and 11 jewel	17 size 1st and 2d models.
16	817	.104	.0075	2.64	.190	21 jewel	All 16 size models having going barrels.
16	817	.104	.00775	2.64	.196	17 and 15 jewel	
16	817	.104	.008	2.64	.203	7 and 15 jewel	
16	2325	.104	.0075	2.64	.190	7 and 15 jewel	16 size in some of the very old numbers.
16	2542	.104	.00725	2.64	.184	21 and 23 jewel	All 16 size having steel safety barrels.
16	2542	.104	.0075	2.64	.190	17 and 19 jewel	
14	2329	.081	.00775	2.05	.196	7, 15 and 17 jewel	14 size 2d model.
12	1712	.088	.00725	2.23	.184	19 and 23 jewels	12 size 2d and 3d models having steel barrels.
12	1712	.088	.0075	2.23	.190	7, 15 and 17 jewel	
12	1720	.088	.0075	2.23	.190	7, 15 and 17 jewel	12 size 2d and 3d models having thick going barrels.
12	2339	.081	.0075	2.05	.190	17 jewel	12 size 2d and 3d models having thin going barrels.
12	2339	.081	.00775	2.05	.196	7 and 15 jewel	
12	2874	.065	.00725	1.65	.184	17 jewel	12 size 4th model.
10	823	.092	.007	2.33	.177	7 and 15 jewel	10 size 1st model K. W.
10	2326	.092	.007	2.33	.177	7 and 15 jewel	10 size 1st model K. W.
6	824	.074	.00675	1.88	.171	17 jewel	6 size 1st and 2d models.
6	824	.074	.007	1.88	.177	7 and 15 jewel	
6	2327	.074	.007	1.88	.177	7 and 15 jewel	6 size 1st model.
0	825	.050	.00625	1.27	.158	7 and 15 jewel	0 size 1st model.
0	2328	.050	.00625	1.27	.158	7 and 15 jewel	0 size 1st model.
0	1713	.065	.0055	1.65	.139	7, 15 and 17 jewel	0 size 2d and 3d models having steel safety barrels.
0	2097	.065	.0055	1.65	.139	15 and 17 jewel	0 size 2d and 3d models having going barrels.
0	2097	.065	.00575	1.65	.146	7 jewel	
5/0	2705	.050	.00525	1.27	.133	15 jewel	5/0 size 1st model, used only in grade 380.
5/0	2890	.050	.0045	1.27	.114	15 jewel	5/0 size 1st and 2d models.
5/0	2890	.050	.00475	1.27	.120	7 jewel	
10/0	1957	.050	.0045	1.27	.114	17 jewel	10/0 size 1st model.
10/0	1957	.050	.00475	1.27	.120	15 jewel	

No. 812  Htg. or O. F.	No. 816, 2324  Htg. or O. F.	No. 817  Htg. or O. F.	No. 823  Htg.
No. 824  Htg.	No. 825  Htg.	No. 1712  Htg. or O. F.	No. 1713  Htg. or O. F.
No. 1720, 2339  Htg. or O. F.	No. 1956  Htg. or O. F.	No. 1957, 2705, 2890  Htg. or O. F.	No. 2097  Htg. or O. F.
No. 2325  Htg. or O. F.	No. 2326  Htg.	No. 2327  Htg.	No. 2328  Htg.
	No. 2542  Htg. or O. F.	No. 2874  O. F.	

ALL SIZES AND STRENGTHS OF MAIN SPRINGS ARE \$1.25 PER DOZEN

ILLUSTRATIONS OF MAIN SPRING PACKAGE



The above illustration is two-thirds actual size



Envelope

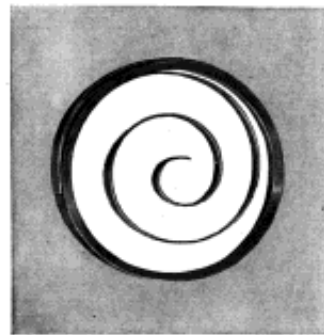

Container

ALL SIZES AND STRENGTHS OF MAIN SPRINGS ARE \$1.25 PER DOZEN

EXTRA LIGHT MAIN SPRINGS

In some instances standard strength springs for any grade movement may give the Balance too much motion.

To take care of such instances we are prepared to supply Extra Light Springs. In ordering these springs give the catalogue number and specify Extra Light.



We carry these springs in stock in the following numbers and strengths and will supply other numbers to order

Size	Catalogue No.	Width in Thousandths of an Inch	Thickness in Thousandths of an Inch	Width in Millimeters	Thickness in Millimeters
18	812	.115	.00825	2.92	.209
16	817	.104	.00725	2.64	.184
14	2339	.081	.0075	2.05	.190
12	1720	.088	.00725	2.23	.184
12	2874	.065	.007	1.65	.177
0	825	.050	.006	1.27	.152
0	1713	.065	.00525	1.65	.133
0	2097	.065	.00525	1.65	.133
5/0	2705	.050	.005	1.27	.127

Should still lighter springs be required specify strength desired in thousandths of an inch or hundredths of a millimeter.

SPRINGS, REGULATOR

















Catalogue No.	CLASS	PRICE		DESCRIPTION OF MOVEMENT		
		Piece	Per Doz.	Size	Model	
2518	119, 121.....	.60	7.00	18	F. Pl.	10th, 11th
2518	118, 120.....	.50	5.00	"	"	"
2658	65.....	.10	.75	"	"	7th
2658	90, 91, 134.....	.10	.75	"	3/4 Pl.	8th
2658	98, 102, 126, 132.....	.10	.75	16	"	14th, 15th, 17th
826	24, 25, 29, 30.....	.30	3.00	"	"	3d, 5th

No. 826  Htg. or O. F.	No. 2518  Htg. or O. F.	No. 2658  Htg. or O. F.
--	---	---

SPRINGS, SETTING

Catalogue No.	CLASS	PRICE		DESCRIPTION OF MOVEMENT		
		Piece	Per Doz.	Size	Model	
32	1.....	.10	1.00	18	F. Pl.	2d to 4th
22	2 to 5.....	.10	.75	"	"	"
44	1.....	.10	1.00	"	"	"
44	2 to 4, 119.....	.10	.75	"	"	2d to 4th, 10th
51	4, 5.....	.10	.75	"	"	2d to 4th
52	4, 5, 118.....	.10	.75	"	"	2d to 4th, 10th
129	7 to 11, 63 to 65, 104 to 106, 120 to 122, 124.....	.10	.50	"	"	5th, 7th, 11th
88	12 to 14.....	.25	2.50	"	3/4 Pl.	6th
88	16, 21.....	.30	3.00	16	"	1st, 2d
88	17 to 20, 22, 23.....	.25	2.50	"	"	"
129	24 to 28.....	.10	.50	"	"	3d, 4th
830	29, 30.....	.15	1.25	"	"	5th
830	31.....	.10	1.00	"	"	"
1477	32, 36, 37, 41.....	.15	1.50	"	"	6th, 7th
1477	33, 34, 38, 39.....	.15	1.25	"	"	"
1477	35, 40.....	.10	1.00	"	"	"
1478	32, 36, 37, 41.....	.15	1.50	"	"	"
1478	33, 34, 38, 39.....	.15	1.25	"	"	"
1478	35, 40, 92 to 95, 107 to 110.....	.10	1.00	"	"	"
1909	128, 139.....	.10	1.00	14	"	2d
1909	87, 88, 100, 101, 111 to 114.....	.10	1.00	12	"	2d, 3d
*1908	67 to 69, 71 to 73.....	.15	1.50	"	"	"
1908	70, 74.....	.10	1.00	"	"	"
*2772	135.....	.15	1.50	"	"	4th
104	49 to 51.....	.10	.75	6	"	1st
148	52.....	.10	.50	"	"	"
1479	53 to 55.....	.10	.75	"	"	2d
1479	56, 75, 115.....	.10	.50	"	"	"
832	57 to 59.....	.10	.75	0	"	1st
832	60, 84.....	.10	.50	"	"	"
1910	76, 77, 80, 81.....	.15	1.50	"	"	2d, 3d
1910	78, 79, 82, 83, 85, 86, 116, 117.....	.10	1.00	"	"	"
1911	133, 136.....	.10	.75	5/0	"	1st, 2d
1911	96.....	.10	1.00	10/0	"	1st
1911	97.....	.10	.75	"	"	"

*Nos. 1908 and 2772 are the same excepting that 2772 is thinner and is only suitable for 12 Size 4th model grades.

No. 32  Htg.	No. 44, 51  Htg.	No. 52  Htg.	No. 88  Htg. or O. F.	No. 104  Htg.	No. 129  O. F.
No. 148  Htg.	No. 830  O. F.	No. 832  Htg.	No. 1477  Htg. or O. F.	No. 1478  Htg. or O. F.	
No. 1479  Htg.	No. 1908, 2772  Htg. or O. F.	No. 1909  Htg. or O. F.	No. 1910  Htg. or O. F.	No. 1911  Htg. or O. F.	

SHIPPERS, SETTING

Catalogue No.	CLASS	PRICE		DESCRIPTION OF MOVEMENT		
		Piece	Per Doz.	Size	Model	
92	12 to 14.....	.15	1.50	18	¼ Pl.	6th
92	16, 21.....	.30	3.00	16	"	1st, 2d
92	17 to 20, 22, 23.....	.15	1.50		"	"

No. 92



Htg. or O. F.

STOP WORKS, FEMALE

Catalogue No.	CLASS	PRICE		DESCRIPTION OF MOVEMENT		
		Piece	Per Doz.	Size	Model	
12	1, 2, 7, 65.....	.10	1.00	18	F. Pl.	1st to 5th, 7th
838	16, 21, 36, 41.....	.10	1.00	16	¼ Pl.	1st, 2d, 6th, 7th
838	46.....	.10	1.00	10	"	1st

No. 12



Htg. or O. F.

No. 838



Htg. or O. F.

STOP WORKS, MALE

Catalogue No.	CLASS	PRICE		DESCRIPTION OF MOVEMENT		
		Piece	Per Doz.	Size	Model	
11	1, 2, 7, 65.....	.10	1.00	18	F. Pl.	1st to 5th, 7th
842	16, 21, 36, 41.....	.10	1.00	16	¼ Pl.	1st, 2d, 6th, 7th
842	46.....	.10	1.00	10	"	1st

No. 11



Htg. or O. F.

No. 842



Htg. or O. F.

STUDS, MAIN WHEEL

Catalogue No.	CLASS	PRICE		DESCRIPTION OF MOVEMENT		
		Piece	Per Doz.	Size	Model	
119	12 to 14.....	.10	1.00	18	¼ Pl.	6th
119	16 to 23.....	.10	1.00	16	"	1st, 2d

No. 119



Htg. or O. F.

Read the introduction page carefully, as it explains fully our system of cataloging.

STAFFS, BALANCE

Catalogue No.	CLASS	PRICE		DESCRIPTION OF MOVEMENT		
		Piece	Per Doz.	Size	Model	
*2516	1, 65, 119, 121	.30	3.00	18	F. Pl.	2d to 4th, 7th, 10th, 11th
† 857	1 to 4, 7 to 9, 65, 66, 118, 120	.30	3.00	"	"	1st to 5th, 7th
† 857	103 to 106, 122 to 124	.15	1.50	"	"	2d to 5th, 7th
† 857	5, 6, 10, 11, 61 to 64	.10	1.00	"	"	1st to 5th
861	12, 13	.30	3.00	"	3/4 Pl.	6th
861	14	.10	1.00	"	"	"
*1901	88 to 91, 99	.30	3.00	"	"	8th, 9th
†1902	90, 91, 99	.30	3.00	"	"	"
†2659	134	.30	3.00	"	"	8th
†2659	130, 131	.15	1.50	"	"	8th, 9th
860	15	.10	1.00	17	F. Pl.	1st, 2d
† 861	16 to 19, 21 to 25, 27 to 30, 32 to 34, 36 to 39, 41, 98, 102	.30	3.00	16	3/4 Pl.	1st to 7th, 9th
† 861	107 to 110, 127	.15	1.50	"	"	6th, 7th, 9th
† 861	20, 26, 31, 35, 40, 92 to 95	.10	1.00	"	"	1st, 3d to 5th, 7th
*2532	36, 41, 98, 102, 125, 126, 132	.30	3.00	"	"	6th to 9th, 13th to 15th, 17th
866	42, 43	.30	3.00	14	"	1st
1905	128, 129	.15	1.50	"	"	2d
†2802	128, 129	.15	1.50	"	"	"
867	44, 45	.30	3.00	12	"	1st
1905	67 to 90, 71 to 73	.30	3.00	"	"	2d, 3d
1905	111 to 114	.15	1.50	"	"	"
1905	70, 74, 87, 88, 100, 101	.10	1.00	"	"	"
†2802	111 to 114	.15	1.50	"	"	"
*2660	67, 71	.30	3.00	"	"	"
†2773	135	.30	3.00	"	"	4th
*4006	135	.15	1.50	"	"	"
867	46 to 48	.30	3.00	10	"	1st
868	49 to 51, 53 to 55	.30	3.00	6	"	1st, 2d
868	115	.15	1.50	"	"	2d
868	52, 56, 75	.10	1.00	"	"	1st, 2d
† 869	57 to 59, 76, 77, 80, 81	.30	3.00	0	"	1st to 3d
† 869	116, 117	.15	1.50	"	"	2d, 3d
† 869	60, 78, 79, 82, 83, 85, 86	.10	1.00	"	"	1st to 3d
1731	84	.10	1.00	"	"	1st
†2661	133, 136	.15	1.50	5/0	"	1st, 2d
1907	96, 97	.30	3.00	10/0	"	1st
†2661	96, 97	.15	1.50	"	"	"

*For Double Rollers (two piece type).
†For Double Rollers (combination type)
‡For Double Rollers (combination type) also for Single Rollers

IMPORTANT BALANCE STAFF INFORMATION

18 SIZE NUMBER 857

No. 857 are made in two lengths and with short and long hubs. The short Staffs are known as Old Style and the long as New Style.

In ordering these Staffs specify style wanted. O. S. H. affixed to 857 means Old Style Short Hub. O. L. H. Old Style Long Hub—N. S. H. New Style Short Hub.

The style most commonly used is New Style Long Hub and when these are wanted order No. 857.

16 SIZE NUMBER 861

No. 861 are made in two lengths and with Large and Small Roller Arbor. The short are known as Old Style and the long as New Style.

In ordering these Staffs if Old Style are wanted affix the letter O to No. 861 and if Old Style Small Roller Arbor are wanted, specify No. 861 O. S. R. A. The Staffs most used in this number are New Style Large Roller Arbor and if these are wanted specify No. 861.

Small Roller Arbors are .298 of an inch or .53 of a M. M. in diameter and large are .348 of an inch or .63 M. M. measured immediately below hub.

12 SIZE NUMBER 1905

No. 1905 are made with two lengths of hubs; if the short hubs are required specify No. 1905 S. The long hub Staffs are most used in this number and when these are wanted specify No. 1905.

6 SIZE NUMBER 868

No. 868 are made in two lengths, the Old Style being the longer.

In ordering Old Style specify Number 868 O. The Staffs most used in this number are New Style and when these are wanted specify No. 868.

OLD STYLE STAFFS

Nos. 857, 861 and 868 Old Style were used in most watches made prior to 3,000,000.

LONG HUB STAFFS

The length of hubs in some numbers of Staffs were increased to bring the roller nearer the Fork, allowing the use of shorter Jewel Pins thereby reducing the liability of Jewel Pin breakage.

ABOUT PIVOT SIZES

We send out Staffs with assorted size pivots unless otherwise ordered.

We carry in stock a line of Staffs with gauged pivots which we supply on request.

In ordering gauged Staffs specify size of pivot wanted in hundredths of a M. M. in addition to catalogue number and class.

ASSORTMENTS

Our gauged Staffs and Jewels put up in assortments are very convenient and will save time in making selections. They are listed on Pages 132 to 135.

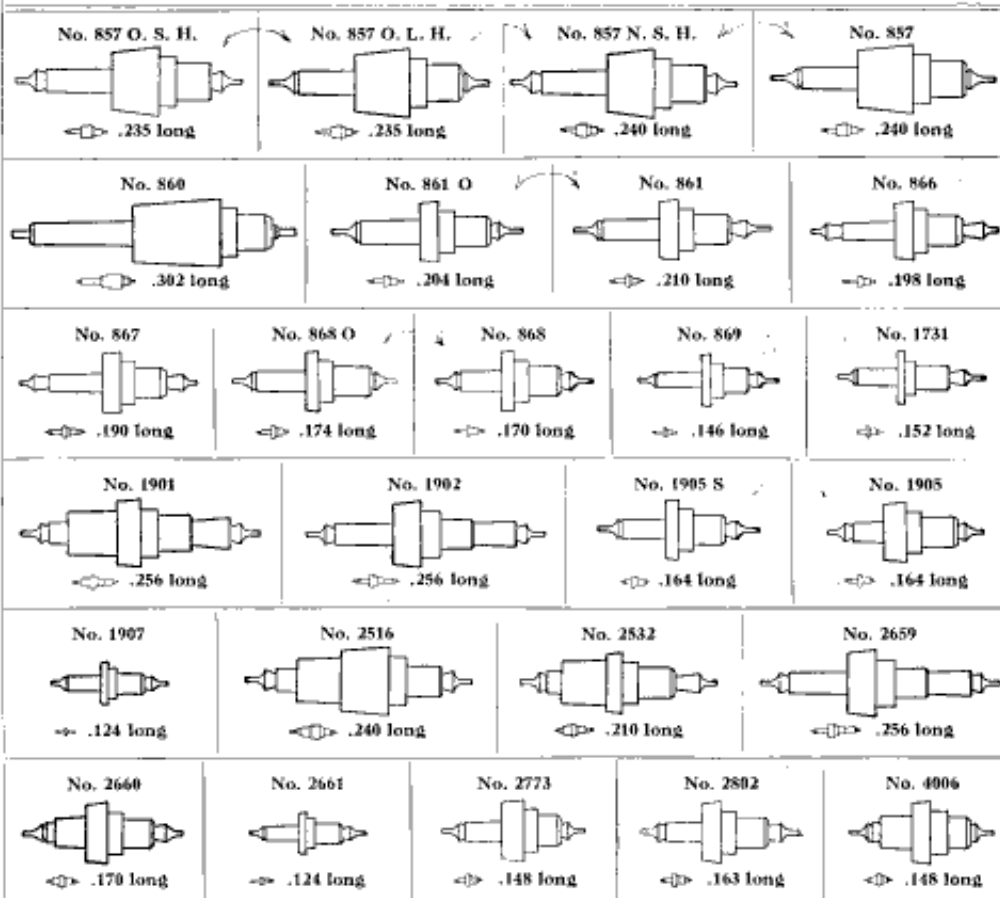

Illustrations of Balance Staffs are shown in two sizes so that any peculiarity in shape may be more easily discerned. The smaller illustration is actual size and the larger five times actual size. The figures under each illustration represent the total length of Staff in thousandths of an inch.

To assist in determining the proper Staff, measure total length of Staff to be replaced and compare with the measurements given under the illustrations in thousandths of an inch.

TABLE OF BALANCE STAFF LENGTHS

Showing the Lengths in Thousandths of an Inch and Equivalent Lengths in Millimeters

Inches	Millimeters	Inches	Millimeters
.124	3.15	.190	4.83
.146	3.71	.198	5.03
.148	3.76	.204	5.18
.152	3.86	.210	5.33
.163	4.14	.235	5.97
.164	4.17	.240	6.10
.170	4.32	.256	6.50
.174	4.42	.302	7.67

DOUBLE ROLLER BALANCE STAFFS

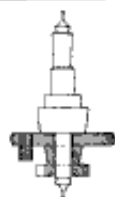

The Balance Staffs used only in connection with the combination type of Double Roller are Nos. 2659, 2661, 2773, 2802.

It will be observed that in several instances the same Staff is used in connection with both Single Rollers and Combination Type of Double Rollers. These Staffs are Nos. 857, 1902, 861 and 869.

DOUBLE ROLLER BALANCE STAFFS





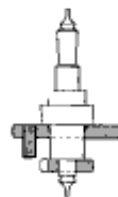











The Balance Staffs used in connection with the two piece type of Double Roller are Nos. 1901, 2516, 2532, 2660, 4006.

It will be observed that these Staffs have an extra shoulder for the Safety Roller.



STAFFS, CENTER

Catalogue No.	CLASS	PRICE		DESCRIPTION OF MOVEMENT			
		Piece	Per Doz.	Size	Model		
14	1 to 5.....	.35	3.50	18	P. Pl.	1st	Old Style
870	1 to 4.....	.35	3.50	"	"	"	New Style
870	5, 6, 61.....	.25	2.50	"	"	"	"
871	1 to 5.....	.35	3.50	"	"	2d to 4th	Old Style
2357	1 to 4, 7 to 9, 65, 66, 118, to 121.....	.35	3.50	"	"	2d to 5th, 7th, 10th, 11th	New Style
2357	5, 6, 10, 11, 61 to 64, 103 to 106, 122 to 124.....	.25	2.50	"	"	2d to 5th, 7th	"
882	12 to 14.....	.35	3.50	"	3/4 Pl.	6th	"
2662	134.....	.35	3.50	"	"	8th	"
2662	130, 131.....	.25	2.50	"	"	8th, 9th	"
882	16 to 23.....	.35	3.50	16	"	1st, 2d	"
2358	24, 25, 29, 30.....	.35	3.50	"	"	3d, 5th	"
2358	26, 31.....	.25	2.50	"	"	"	"
879	27, 28.....	.40	4.00	"	"	4th	"
1482	32 to 34, 36 to 39, 41, 98, 102, 125, 126, 132.....	.35	3.50	"	"	6th to 9th, 13th to 15th, 17th	"
1482	35, 40, 92 to 95, 107 to 110, 127.....	.25	2.50	"	"	6th, 7th, 9th	"
881	42, 43.....	.35	3.50	14	"	1st	Old Style
2663	128, 129.....	.25	2.50	"	"	2d	New Style
881	44, 45.....	.35	3.50	12	"	1st	Old Style
1716	67 to 69, 71 to 73.....	.35	3.50	"	"	2d, 3d	New Style
1716	70, 74, 87, 88, 100, 101, 111 to 114.....	.25	2.50	"	"	"	"
2774	135.....	.35	3.50	"	"	4th	"
881	46 to 48.....	.35	3.50	10	"	1st	Old Style
882	47, 48.....	.35	3.50	"	"	"	New Style
2359	49 to 51.....	.35	3.50	6	"	"	"
2359	52.....	.25	2.50	"	"	"	"
2360	53 to 55.....	.35	3.50	"	"	2d	"
2360	56, 75, 115.....	.25	2.50	"	"	"	"
2361	57 to 59.....	.35	3.50	0	"	1st	"
2361	60, 84.....	.25	2.50	"	"	"	"
2056	77, 81.....	.35	3.50	"	"	2d, 3d	"
2056	85, 86, 116, 117.....	.25	2.50	"	"	"	"
2809	133, 136.....	.35	3.50	5/0	"	1st, 2d	"

No. 14  Htg.	No. 870  Htg.	No. 871  Htg.	No. 879  Htg. or O. F.	No. 881, 882  Htg. or O. F.	No. 1482  Htg. or O. F.
No. 1716  Htg. or O. F.	No. 2056  Htg. or O. F.	No. 2357  Htg. or O. F.	No. 2358  Htg. or O. F.	No. 2359, 2360  Htg.	No. 2361  Htg.
	No. 2662  Htg. or O. F.	No. 2663  Htg. or O. F.	No. 2774  O. F.	No. 2809  Htg. or O. F.	

The Wheel Shoulder on most Center Staffs is D shaped, and fits a corresponding hole in the Center Wheel. The two pieces are held together by screwing on the Center Pinion, between which and the Wheel a thin steel Washer is placed.

In a number of instances the Center Staff and Center Pinion are in one piece. If a combination of this kind is required it will be found listed under the head of Center Pinions.

On Old Style Center Staffs the Center Pinion is held in position with a Center Pinion Nut. The New Style, the Center Pinion is screwed on Staff.

To ascertain Grade and Class of movement refer to numbers in the back of the catalogue under the head of "Number and Grade with classification and description of movements." To find where the particular kind of material required is listed, refer to the index, which will be found on the last pages of this catalogue.

STUDS, HAIR SPRING

Catalogue No.	CLASS	PRICE		DESCRIPTION OF MOVEMENT			Kind of Spring
		Piece	Per Doz.	Size	Model		
843	1 to 11, 61 to 66, 103 to 106, 122 to 124	10	.60	18	F. Pl.	1st to 5th, 7th	Breguet
2517	118 to 121	10	.60	"	"	10th, 11th	"
844	1 to 6, 9 to 11, 61	10	.60	"	"	1st to 5th	Flat
845	5	10	.60	"	"	1st	"
849	12 to 14	10	.60	"	3/4 Pl.	6th	"
1916	89 to 91, 99	10	.60	"	"	8th, 9th	Breguet
2664	130, 131, 134	10	.60	"	"	"	"
845	15	10	.60	17	F. Pl.	1st, 2d	Flat
847	16, 21	10	.60	16	3/4 Pl.	"	Breguet
1480	16, 17, 21, 22, 24, 25, 29, 30, 32 to 41, 92 to 95, 98, 102, 107 to 110, 125 to 127, 132	10	.60	"	"	1st to 3d, 6th to 9th, 13th to 15th, 17th	"
849	17 to 20, 22 to 28, 30, 31	10	.60	"	"	1st to 5th	Flat
850	42, 43	10	.60	14	"	1st	"
1917	128, 129	10	.60	"	"	2d	Breguet
850	44, 45	10	.60	12	"	1st	Flat
1917	67 to 74, 87, 88, 100, 101, 111 to 114	10	.60	"	"	2d, 3d	Breguet
2775	135	10	.60	"	"	4th	"
850	46 to 48	10	.60	10	"	1st	Flat
851	49, 53	10	.60	6	"	1st, 2d	Breguet
1481	53 to 56, 75, 115	10	.60	"	"	2d	"
852	50 to 52, 54 to 56	10	.60	"	"	1st, 2d	Flat
853	57 to 60, 76 to 86, 116, 117	10	.60	0	"	1st to 3d	Breguet
854	58 to 60	10	.60	"	"	1st	Flat
1903	133, 136	10	.60	5/0	"	1st, 2d	Breguet
1903	95, 97	10	.60	10/0	"	1st	"

No. 843, 1916 ▽ ⊕ Htg. or O. F.	No. 844 ▽ ⊕ Htg. or O. F.	No. 845 □ Htg.	No. 847, 1480, 2517 ▽ ⊕ Htg. or O. F.	No. 849 ▽ ⊕ Htg. or O. F.	No. 850, 852 ▽ ⊕ Htg.
No. 851 ○ ⊕ Htg.	No. 853 ○ ⊕ Htg. or O. F.	No. 854 ▽ ⊕ Htg.	No. 1481 ▽ ⊕ Htg.	No. 1903 ○ ⊕ O. F.	No. 1917 ▽ ⊕ Htg. or O. F.
		No. 2664 ▽ ⊕ Htg. or O. F.	No. 2775 ▽ ⊕ O. F.		

To ascertain Grade and Class of Movement refer to numbers in the back of the catalogue under the head of "Number and Grade with classification and description of movements." To find where the particular kind of material required is listed, refer to the index which will be found on the last pages of this catalogue.

Your Jobber will supply Balance Staffs, Balance Jewels, Hands and Screws in dozen lots in original sealed trade marked packages.

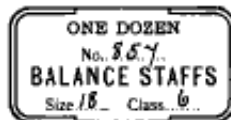

[TOP]

TRADE-MARKED PACKAGE



[BOTTOM]

WASHERS, ARBOR

Catalogue No.	CLASS	PRICE		DESCRIPTION OF MOVEMENT	
		Piece	Per Doz.	Size	Model
940	43.....	.10	1.00	14	1/4 Pl. 1st
940	45.....	.10	1.00	12	" " "
940	48.....	.10	1.00	10	" " "

No. 940



Htg.

WASHERS, CENTER PINION

Catalogue No.	CLASS	PRICE		DESCRIPTION OF MOVEMENT	
		Piece	Per Doz.	Size	Model
1923	89 to 91, 99.....	.10	1.00	18	3/4 Pl. 8th, 9th
1924	76 to 83.....	.10	1.00	0	" " 2d, 3d

No. 1923



Htg. or O. F.

No. 1924



Htg. or O. F.

WASHERS, CENTER STAFF

Catalogue No.	CLASS	PRICE		DESCRIPTION OF MOVEMENT	
		Piece	Per Doz.	Size	Model
1553	1 to 11, 61 to 66, 103 to 106, 118 to 124.....	.10	.30	18	F. Pl. 1st to 5th, 7th, 10th, 11th
2665	130, 131, 134.....	.10	.30	"	3/4 Pl. 8th, 9th
1554	24 to 26, 29 to 41, 92 to 95, 98, 102, 107 to 110, 125 to 127, 132.....	.10	.30	16	" " 3d, 5th to 9th, 13th to 15th, 17th
1555	128, 129.....	.10	.30	14	" " 2d
1556	67 to 74, 87, 88, 100, 101, 111 to 114, 135.....	.10	.30	12	" " 2d to 4th
1555	49 to 56, 75, 115.....	.10	.30	6	" " 1st, 2d
1556	57 to 60, 77, 81, 84 to 86, 116, 117.....	.10	.30	0	" " 1st to 3d
2808	133, 136.....	.10	.30	5/0	" " 1st, 2d

No. 1553, 2665



Htg. or O. F.

No. 1554



Htg. or O. F.

No. 1555



Htg. or O. F.

No. 1556



Htg. or O. F.

No. 2808



Htg. or O. F.

To ascertain Grade and Class of movement refer to numbers in the back of the catalogue under the head of "Number and Grade with classification and description of movements." To find where the particular kind of material required is listed, refer to the index which will be found on the last pages of this catalogue.

Read the introduction page carefully as it explains fully our system of cataloguing.

Orders for less than one-fourth dozen pieces of a kind will be charged at the piece price.

WASHERS, MAIN SCREW

Used on Exposed Winding Wheel Models

Owing to the many different styles of finish on the main screw washers and ratchet wheel washers of our exposed winding wheel models, it has become necessary to abandon the previous system of classifying them. We now list them in four general divisions. In each of these divisions are noted the chief features of the finishes embraced by them which serves in a general way as a guide for ordering.

Catalogue No.	Price		DESCRIPTION OF MOVEMENT			In ordering, specify letter in addition to catalogue number.	
	Piece	Per Doz.	Size	Model			
1919	.25	2.50	18	3/4 Pl.	8th, 9th	A. Cupped and polished	
1484	.25	2.50	16		6th, 7th, 9th, 13th to 15th, 17th		
1920	.25	2.50	14		2d		
1920	.25	2.50	12		2d, 3d		
2776	.25	2.50	12		4th		
1921	.25	2.50	0		2d, 3d		B. Cupped, polished and rayed, corner polished
1921	.25	2.50	3/0		2d, 3d		
1922	.25	2.50	5/0		1st, 2d		
1922	.25	2.50	10/0		1st		
1919	.15	1.50	18		3/4 Pl.		8th, 9th
1484	.15	1.50	16	6th, 7th, 9th, 13th to 15th, 17th			
1920	.15	1.50	14	2d			
1920	.15	1.50	12	2d, 3d			
2776	.15	1.50	12	4th			
1921	.15	1.50	0	2d, 3d		D. Polished	
1921	.15	1.50	3/0	2d, 3d			
1922	.15	1.50	5/0	1st, 2d			
1922	.15	1.50	10/0	1st			
1919	.10	1.00	18	3/4 Pl.		8th, 9th	E. Face rayed and corner polished
1484	.10	1.00	16		6th, 7th, 9th, 13th to 15th, 17th		
1920	.10	1.00	14		2d		
1920	.10	1.00	12		2d, 3d		
2776	.10	1.00	12		4th		
1921	.10	1.00	0		2d, 3d	E. Face rayed and corner polished	
1921	.10	1.00	3/0		2d, 3d		
1922	.10	1.00	5/0		1st, 2d		
1922	.10	1.00	10/0		1st		

No. 1484



Htg. or O. F.

No. 1919



Htg. or O. F.

No. 1920



Htg. or O. F.

No. 1921



Htg. or O. F.

No. 1922



Htg. or O. F.

No. 2776



O. F.

WASHERS, RATCHET WHEEL

Catalogue No.	Price		DESCRIPTION OF MOVEMENT			In ordering, specify letter in addition to catalogue number.
	Piece	Per Doz.	Size	Model		
2777	.20	2.00	18	3/4 Pl.	8th	A. Cupped, polished and rayed, corner polished
1486	.20	2.00	16		6th to 9th, 13th, 15th	
2778	.20	2.00	12		4th	
2057	.20	2.00	0		2d, 3d	
1925	.20	2.00	10/0		1st	
2777	.15	1.50	18	3/4 Pl.	8th	C. Polished
1486	.15	1.50	16		6th to 9th, 13th, 15th	
2778	.15	1.50	12		4th	
2057	.15	1.50	0		2d, 3d	
1925	.15	1.50	10/0		1st	
2777	.10	1.00	18	3/4 Pl.	8th	E. Circular rayed
1486	.10	1.00	16		6th to 9th, 13th, 15th	
2778	.10	1.00	12		4th	
2057	.10	1.00	0		2d, 3d	
1925	.10	1.00	10/0		1st	

No. 1486



Htg. or O. F.

No. 1925



O. F.

No. 2057



Htg. or O. F.

No. 2777



O. F.

No. 2778



O. F.

WHEELS, CENTER—COMPLETE











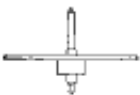
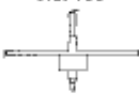















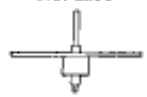
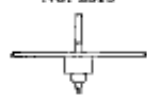



Catalogue No.	CLASS	PRICE		DESCRIPTION OF MOVEMENT		Train	Finish	Teeth	
		Piece	Per Doz.	Size	Model				
2313	1, 2	.70	8.00	18	F. PL. 1st	Quick	Flat	Gilded	80-11
2314	1 to 4	.60	7.00	"	"	"	"	"	80-12
2314	5, 6, 61	.50	6.00	"	"	"	"	"	80-12
2315	3 to 5	.70	8.00	"	"	Slow	"	"	64-10
960	5, 6	.50	5.00	"	"	"	"	"	64-10
2316	1, 2	.70	8.00	"	"	Quick	"	"	80-11
2317	3 to 5	.70	8.00	"	"	Slow	"	"	64-10
964	5, 6	.50	5.00	"	"	"	"	"	64-10
2157	1 to 4, 7 to 9, 65, 66, 118 to 121	.60	7.00	"	"	Quick	"	"	80-12
2157	5, 6, 10, 11, 61 to 64	.50	6.00	"	"	"	"	"	80-12
2157	103 to 106, 122 to 124	.50	6.00	"	"	"	"	"	80-12
2318	12 to 14	.60	7.00	"	"	"	"	"	80-12
1972	89 to 91, 99	1.10	13.00	"	"	"	Oval	Gold	80-12
2712	134	.95	11.00	"	"	"	"	"	80-12
2712	136, 131	.70	8.00	"	"	"	"	Gilded	80-12
967	15	.50	5.00	17	F. PL. 1st	Slow	Flat	"	64-10
968	15	.50	5.00	"	"	"	"	"	64-10
969	15	.50	5.00	"	"	"	"	"	64-10
2319	27	.75	9.00	16	3/4 PL. 4th	Quick	"	Polished	80-12
2319	28	.70	8.00	"	"	"	"	Gilded	80-12
2318	16, 21	.95	11.00	"	"	"	Oval	Gold	80-12
2318	17, 22	.75	9.00	"	"	"	Flat	Polished	80-12
2318	18 to 20, 23	.60	7.00	"	"	"	"	Gilded	80-12
2166	24, 29	.75	9.00	"	"	"	"	Polished	80-12
2166	25, 26, 30, 31	.60	7.00	"	"	"	"	Gilded	80-12
2364	32, 33, 36 to 38, 41, 98, 102	.95	11.00	"	"	"	Oval	Gold	80-12
2158	33 to 35, 38 to 40, 93, 95, 98, 102	.75	9.00	"	"	"	"	Polished	80-12
2158	107 to 110, 125, 127	.75	9.00	"	"	"	"	"	80-12
2067	35, 40, 92, 94, 109, 110	.50	6.00	"	"	"	Flat	Gilded	80-12
2713	98	.75	9.00	"	"	"	Oval	Polished	80-12
2811	41, 98, 102, 125, 128, 132	.95	11.00	"	"	"	"	Gold	80-12
2362	42	.75	9.00	14	"	"	Flat	Polished	80-12
2363	42, 43	.60	7.00	"	"	"	"	Gilded	80-12
2714	128, 129	.50	6.00	"	"	"	"	"	80-12
2320	44	.75	9.00	12	"	"	"	Polished	80-12
2321	44, 45	.70	8.00	"	"	"	"	Gilded	80-12
1973	67, 68, 71, 72	.95	11.00	"	"	"	Oval	Gold	80-12
1973	69, 70, 73, 74	.75	9.00	"	"	"	"	Polished	80-12
2112	100, 101, 111, 112	.75	9.00	"	"	"	"	"	80-12
2112	87, 88, 113, 114	.50	6.00	"	"	"	Flat	Gilded	80-12
2111	70, 74	.50	5.00	"	"	"	"	"	80-12
2780	135	.95	11.00	12	"	"	Oval	Gold	80-12
2321	46	.75	9.00	10	"	"	Flat	Polished	80-12
2321	47, 48	.70	8.00	"	"	"	"	Gilded	80-12
2322	47, 48	.60	7.00	"	"	"	"	"	80-12
2323	49, 50	.75	9.00	6	"	"	"	Polished	80-12
2323	51	.60	7.00	"	"	"	"	Gilded	80-12
2323	52	.50	6.00	"	"	"	"	"	80-12
2159	53, 54	.95	11.00	"	"	"	Oval	Gold	80-12
2159	56	.70	8.00	"	"	"	"	Polished	80-12
2167	55	.60	7.00	"	"	"	Flat	Gilded	80-12
2167	56, 75, 115	.50	6.00	"	"	"	"	"	80-12
2160	57, 58	.95	11.00	0	"	"	Oval	Gold	80-12
2160	60	.70	8.00	"	"	"	"	Polished	80-12
1714	59	.60	7.00	"	"	"	Flat	Gilded	80-12
1714	60, 84	.50	6.00	"	"	"	"	"	80-12
1974	76, 77, 80, 81	.95	11.00	"	"	"	Oval	Gold	80-11
1974	78, 82	.75	9.00	"	"	"	"	Polished	80-11
1974	79, 83	.50	6.00	"	"	"	Flat	Gilded	80-11
1975	79, 83, 85, 86	.50	5.00	"	"	"	"	"	80-11
2082	77, 81	.95	11.00	"	"	"	Oval	Gold	80-12
2082	85, 86, 116, 117	.50	6.00	"	"	"	Flat	Gilded	80-12
2060	116, 117	.50	6.00	"	"	"	"	"	80-12
2881	81, 116, 117	.60	6.00	0x12	"	"	"	"	80-12
2130	133	.65	7.50	5/0	"	"	Oval	Polished	64-10
2815	133	.60	7.00	"	"	"	"	Gilded	64-10
2816	133, 136	.70	8.00	"	"	"	"	Polished	64-10
2130	96, 97	.65	7.50	10/0	"	"	"	"	64-10
2813	96	.85	10.00	"	"	"	"	Gold	64-10
2814	97	.65	7.50	"	"	"	"	Polished	64-10

*Used only in size 0 watches spread to 12.

†Center staff is shorter than the one used in combination No. 2082.

Observe that 18 Size Movements are made both Quick and Slow Train.

WHEELS, CENTER—COMPLETE

<p>No. 960</p>  <p>Htg.</p>	<p>No. 964</p>  <p>Htg.</p>	<p>No. 967</p>  <p>Htg.</p>	<p>No. 968</p>  <p>Htg.</p>
<p>No. 969</p>  <p>Htg.</p>	<p>No. 1714, 2160</p>  <p>Htg.</p>	<p>No. 2971</p>  <p>Htg. or O. F.</p>	<p>No. 1973, 2111, 2112</p>  <p>Htg. or O. F.</p>
<p>No. 1974</p>  <p>Htg. or O. F.</p>	<p>No. 1975</p>  <p>Htg. or O. F.</p>	<p>No. 2067, 2158, 2364, 2713</p>  <p>Htg. or O. F.</p>	<p>No. 2082, 2960</p>  <p>Htg. or O. F.</p>
<p>No. 2130</p>  <p>Htg. or O. F.</p>	<p>No. 2157</p>  <p>Htg. O. F.</p>	<p>No. 2159, 2167, 2323</p>  <p>Htg.</p>	<p>No. 2166</p>  <p>Htg. or O. F.</p>
<p>No. 2313</p>  <p>Htg.</p>	<p>No. 2314</p>  <p>Htg.</p>	<p>No. 2315</p>  <p>Htg.</p>	<p>No. 2316</p>  <p>Htg.</p>
<p>No. 2317</p>  <p>Htg.</p>	<p>No. 2318, 2362, 2363</p>  <p>Htg. or O. F.</p>	<p>No. 2319</p>  <p>Htg. or O. F.</p>	<p>No. 2320, 2321</p>  <p>Htg.</p>
<p>No. 2322</p>  <p>Htg. or O. F.</p>	<p>No. 2712</p>  <p>Htg. or O. F.</p>	<p>No. 2714</p>  <p>O. F.</p>	<p>No. 2780</p>  <p>O. F.</p>
<p>No. 2811</p>  <p>Htg. or O. F.</p>	<p>No. 2813, 2814</p>  <p>Htg.</p>	<p>No. 2815, 2816</p>  <p>Htg. or O. F.</p>	<p>No. 2881</p>  <p>Htg. or O. F.</p>

It will be observed that in some instances more than one number is applied to the same illustration. The reason for this is that a difference exists which cannot be shown by an illustration. This difference is usually explained in the description following the catalogue number.

WHEELS, CENTER

Catalogue No.	Class	PRICE		DESCRIPTION OF MOVEMENT			Train	Finish	Teeth	
		Piece	Per Doz.	Size	P. Pl.	Model				
943	1 to 4, 7 to 9, 65, 66	.20	2 00	18	"	1st to 5th, 7th	Quick	Flat	Gilded	80
943	5, 6, 10, 11, 61 to 64, 103 to 106	.15	1 50	"	"	1st to 5th	"	"	"	80
2296	1 to 4, 7 to 9, 65, 66, 118 to 121	.20	2 00	"	"	1st to 5th, 7th, 10th, 11th	"	"	"	80
2296	5, 6, 10, 11, 61 to 64, 103 to 106	.15	1 50	"	"	"	"	"	"	80
944	3 to 6	.20	2 00	"	"	1st to 5th, 7th	Slow	"	"	64
948	12 to 14	.20	2 00	"	"	1st to 4th	Quick	"	"	80
1928	89 to 91, 99	.50	6 00	"	3/4 Pl.	8th, 9th	"	Oval	Gold	80
2706	154	.50	6 00	"	"	8th	"	"	"	80
2706	130, 131	.30	3 00	"	"	8th, 9th	"	"	Gilded	80
947	15	.20	2 00	17	P. Pl.	1st, 2d	Slow	Flat	"	64
1487	16, 21, 32, 33, 36 to 38, 41	.50	6 00	16	3/4 Pl.	1st, 2d, 6th, 7th	Quick	Oval	Gold	80
1487	98, 102, 126, 132	.50	6 00	"	"	9th, 14th, 15th, 17th	"	"	"	80
2336	33 to 35, 38 to 40, 63, 95, 98, 102	.40	4 00	"	"	6th to 8th, 13th	"	"	Polished	80
2336	107 to 110, 126	.40	4 00	"	"	6th to 8th	"	Flat	"	80
948	17, 22, 24, 27, 29	.30	3 00	"	"	1st to 5th	"	"	Gilded	80
948	18, 19, 23, 25, 28, 30	.15	1 50	"	"	"	"	"	"	80
948	20, 26, 31	.30	3 00	"	"	1st, 3d, 5th	"	"	Polished	80
1567	17, 22, 24, 29	.30	3 00	"	"	1st to 3d, 5th	"	"	Gilded	80
1567	18, 19, 23, 25, 30	.20	2 00	"	"	"	"	"	"	80
1567	26, 31, 35, 40, 92, 94, 109, 110, 127	.15	1 50	"	"	3d, 5th to 7th, 9th	"	"	"	80
1554	42	.30	3 00	14	"	1st	"	"	Polished	80
948	42, 43	.20	2 00	"	"	"	"	"	Gilded	80
1927	128, 129	.15	1 50	"	"	2d	"	"	"	80
1475	44	.30	3 00	12	"	1st	"	"	Polished	80
954	44, 45	.20	2 00	"	"	"	"	"	Gilded	80
1927	67, 68, 71, 72, 135	.50	6 00	"	"	2d to 4th	"	Oval	Gold	80
1927	69, 70, 73, 74, 100, 101, 111, 112	.40	4 00	"	"	2d, 3d	"	"	Polished	80
1927	87, 88, 113, 114	.15	1 50	"	"	"	"	Flat	Gilded	80
*2156	70, 74	.15	1 50	"	"	"	"	"	"	80
954	46	.30	3 00	10	"	1st	"	"	Polished	80
954	47, 48	.20	2 00	"	"	"	"	"	Gilded	80
955	49, 50	.30	3 00	6	"	"	"	"	Polished	80
955	51, 55	.20	2 00	"	"	1st, 2d	"	"	Gilded	80
955	52, 56	.15	1 50	"	"	"	"	"	"	80
2297	49, 50	.30	3 00	"	"	1st	"	"	Polished	80
2297	51, 55	.20	2 00	"	"	1st, 2d	"	"	Gilded	80
2297	52, 56, 75, 115	.15	1 50	"	"	"	"	"	"	80
1552	53, 54	.50	6 00	"	"	2d	"	Oval	Gold	80
1552	56	.40	4 00	0	"	1st	"	"	Polished	80
956	59	.20	2 00	0	"	"	"	Flat	Gilded	80
956	60	.15	1 50	"	"	"	"	"	"	80
1928	57, 58, 76, 77, 80, 81	.50	6 00	"	"	1st to 3d	"	Oval	Gold	80
1928	60, 78, 82	.40	4 00	"	"	1st	"	"	Polished	80
1918	59	.20	2 00	"	"	"	"	Flat	Gilded	80
1918	60, 79, 83 to 86, 110, 117	.15	1 50	"	"	1st to 3d	"	"	"	80
*2335	79, 83, 85, 86	.15	1 50	"	"	2d, 3d	"	"	"	80
1929	133	.40	4 00	5/0	"	1st	"	Oval	Polished	64
2810	133, 136	.40	4 00	"	"	1st, 2d	"	"	"	64
2810	133	.30	3 00	"	"	1st	"	"	Gilded	64
1929	96	.50	6 00	10/0	"	"	"	"	Gold	64
1929	97	.40	4 00	"	"	"	"	"	Polished	64

*Used with solid Center Pinion, to be staked on.

Observe that 18 Size Movements are made both Quick and Slow Train.

The hole in most Center Wheels is D shaped and fits a corresponding shoulder on Center Staff. The two pieces are held together by screwing on the Center Pinion, between which and the Wheel a thin steel Washer is placed.

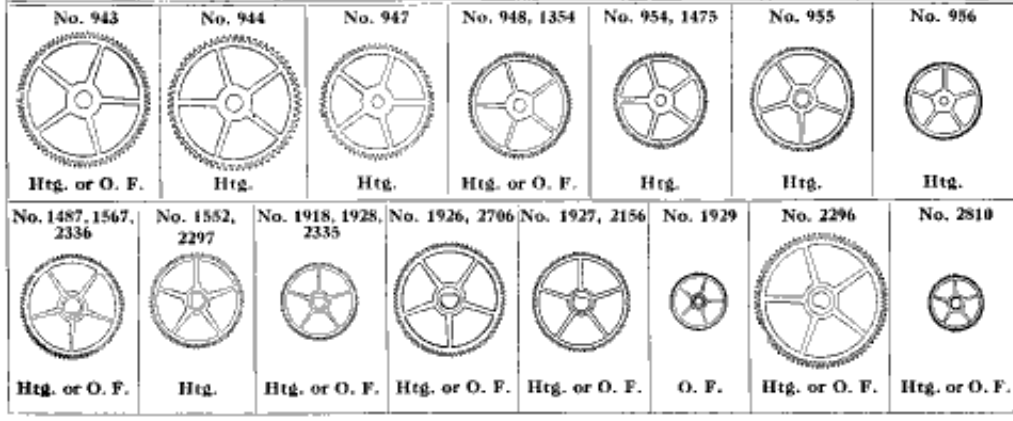

WHEELS, ESCAPE

Catalogue No.	CLASS	PRICE		DESCRIPTION OF MOVEMENT		Finish	Teeth
		Piece	Per Doz.	Size	Model		
2168	1, 7, 65, 119, 121	.50	6.00	18	F. Pl. 2d to 5th, 7th, 10th, 11th	Flat	Steel 15
2168	106, 124	.40	4.00	"	" " 5th, 7th	"	" 15
981	1 to 4, 7 to 9, 66, 118, 120	.20	2.00	"	" " 1st to 5th, 7th, 10th, 11th	"	Gilded 15
981	5, 6, 10, 11, 61 to 64	.15	1.50	"	" " 1st to 5th	"	" 15
981	103 to 106, 122 to 124	.15	1.50	"	" " 2d to 5th, 7th	"	" 15
985	12 to 14	.20	2.00	"	" " 6th	"	" 15
2168	89 to 91, 99	.75	9.00	"	" " 8th, 9th	Oval	Steel 15
2168	134	.50	6.00	"	" " 8th	Flat	" 15
2168	130, 131	.40	4.00	"	" " 8th, 9th	"	" 15
981	15	.15	1.50	17	F. Pl. 1st, 2d	"	Gilded 15
2168	16, 21, 32, 36, 37, 41, 98, 102, 125, 126, 132	.75	9.00	16	1/4 Pl. 1st, 2d, 6th to 9th, 13th, 14th, 17th	Oval	Steel 15
2168	98	.50	6.00	"	" " 15th	Flat	" 15
2168	33, 38, 107, 108, 127	.40	4.00	"	" " 6th, 7th, 9th, 15th	"	" 15
985	17, 22	.30	3.00	"	" " 1st, 2d	"	Polished 15
985	18, 19, 23 to 25, 27 to 30	.20	2.00	"	" " 1st to 5th	"	Gilded 15
985	33, 34, 38, 39, 107 to 110, 127	.20	2.00	"	" " 6th, 7th, 9th	"	" 15
985	20, 26, 31, 35, 40, 92 to 95	.15	1.50	"	" " 1st, 3d, 5th to 7th	"	" 15
1557	42	.30	3.00	14	" " 1st	"	Polished 15
991	42, 43	.20	2.00	"	" " "	"	Gilded 15
1490	129	.40	4.00	"	" " 2d	"	Steel 15
1490	128, 129	.15	1.50	"	" " "	"	Gilded 15
1558	44	.30	3.00	12	" " 1st	"	Polished 15
991	44, 45	.20	2.00	"	" " "	"	Gilded 15
1490	67, 68, 71, 72	.75	9.00	"	" " 2d, 3d	Oval	Steel 15
1490	111 to 114	.40	4.00	"	" " "	Flat	" 15
1490	69, 70, 73, 74	.20	2.00	"	" " "	"	Gilded 15
1490	111 to 114	.15	1.50	"	" " "	"	" 15
991	87, 88, 100, 101	.15	1.50	"	" " "	"	" 15
2781	135	.75	9.00	"	" " 4th	Oval	Steel 15
991	46	.30	3.00	10	" " 1st	Flat	Polished 15
991	47, 48	.20	2.00	"	" " "	"	Gilded 15
1559	49, 50	.30	3.00	6	" " "	"	Polished 15
991	50, 51	.20	2.00	"	" " "	"	Gilded 15
991	52, 75	.15	1.50	"	" " 1st, 2d	"	" 15
1490	53, 54	.30	3.00	"	" " 2d	"	Polished 15
1490	55	.20	2.00	"	" " "	"	Gilded 15
1490	56, 115	.15	1.50	"	" " "	"	" 15
2365	57, 58	.30	3.00	6	" " 1st	"	Polished 15
993	76, 80	.75	9.00	"	" " 2d, 3d	Oval	Steel 15
993	57, 58, 77, 81	.40	4.00	"	" " 1st to 3d	Flat	" 15
993	59	.20	2.00	"	" " "	"	Gilded 15
993	60, 78, 79, 82 to 86, 116, 117	.15	1.50	"	" " "	"	" 15
1955	133, 136	.20	2.00	5/0	" " 1st, 2d	"	" 15
1955	96	.75	9.00	10/0	" " 1st	Oval	Steel 15
1955	97	.20	2.00	"	" " "	Flat	Gilded 15

No. 981, 985, 2168



Htg. or O. F.

No. 991, 1557, 1558



Htg. or O. F.

No. 993, 2365



Htg. or O. F.

No. 1490, 1559



Htg. or O. F.

No. 1955



Htg. or O. F.

No. 2781



O. F.

Two sizes of Escape Wheels have been made in the 18, 16 and 6 Sizes; the larger size being known as New Style, and all orders will be filled with such, unless Old Style is mentioned.

TABLE OF ESCAPE WHEEL DIAMETERS

Showing the Diameter of Old and New Style Escape Wheels in Thousandths of an Inch and Equivalent Diameters in Millimeters

	Inches	Millimeters
18 and 16 Old Style	.328	8.33
18 and 16 New Style	.345	8.76
6 Old Style	.284	7.21
6 New Style	.293	7.44

WHEELS, ESCAPE AND PINION

Catalogue No.	CLASS	PRICE		DESCRIPTION OF MOVEMENT		Train	Pivot	Wheel		Teeth
		Piece	Per Doz.	Size	Model					
2337	1, 7, 65, 119, 121	1.00	12.00	18	F. Pl. 2d to 5th, 7th, 10th, 11th	Quick	Cone	Flat	Steel	15-8
1491	1, 7	.70	8.00	"	" 2d to 5th	"	"	"	Gilded	15-8
2338	1, 7, 65, 119, 121	.85	10.00	"	" 2d to 5th, 7th, 10th, 11th	"	Straight	"	Steel	15-8
994	1 to 4, 7 to 9, 66, 118, 120	.50	6.00	"	" 1st to 5th, 7th, 10th, 11th	"	"	"	Gilded	15-8
994	103 to 106, 122 to 124	.50	5.00	"	" 2d to 5th, 7th	"	"	"	"	15-8
994	5, 6, 10, 11, 61 to 64	.40	4.00	"	" 1st to 5th	"	"	"	"	15-8
2337	106	.85	10.00	"	" 5th	"	Cone	"	Steel	15-8
2812	124	.60	7.00	"	" 7th	"	Straight	"	"	15-8
995	3, 4	.50	6.00	"	" 1st to 4th	Slow	"	"	Gilded	15-7
995	5, 6	.40	4.00	"	"	"	"	"	"	15-7
999	12 to 14	.50	6.00	"	"	Quick	"	"	"	15-8
1976	89 to 91, 99	1.25	15.00	"	3/4 Pl. 6th	"	Cone	Oval	Steel	15-8
1977	91	1.10	13.00	"	" 8th, 9th	"	Straight	"	"	15-8
1977	130, 131	.70	8.00	"	" 8th	"	"	Flat	"	15-8
2783	134	1.00	12.00	"	" 8th, 9th	"	Cone	"	"	15-8
2782	134	.85	10.00	"	" 8th	"	Straight	"	"	15-8
998	15	.40	4.00	17	F. Pl. 1st, 2d	Slow	"	"	Gilded	15-7
1492	16, 21	1.25	15.00	16	3/4 Pl. 1st	Quick	Cone	Oval	Steel	15-8
1494	36, 41, 98, 126, 132	1.25	15.00	"	" 6th, 7th, 13th to 15th, 17th	"	"	"	"	15-8
999	17, 22	.60	7.00	"	" 1st, 2d	"	Straight	Flat	Polished	15-8
999	18, 19, 23 to 25, 27 to 30	.50	6.00	"	" 1st to 5th	"	"	"	Gilded	15-8
999	20, 26, 31	.40	4.00	"	" 1st, 3d, 5th	"	"	"	"	15-8
1493	32, 37, 98, 102, 125, 126	1.10	13.00	"	" 6th to 9th, 13th to 15th, 17th	"	"	Oval	Steel	15-8
1493	33, 38	.70	8.00	"	" 6th, 7th	"	"	Flat	"	15-8
1493	107 to 110, 127	.60	7.00	"	" 6th, 7th, 9th	"	"	"	"	15-8
1493	33, 34, 38, 39	.50	6.00	"	" 6th, 7th	"	"	"	Gilded	15-8
1493	107 to 110, 127	.50	5.00	"	" 6th, 7th, 9th	"	"	"	"	15-8
1493	31, 35, 40, 92 to 95	.40	4.00	"	" 5th to 7th	"	"	"	"	15-8
2169	98	1.25	15.00	"	" 9th	"	Cone	Oval	Steel	15-8
1560	42	.60	7.00	14	" 1st	"	Straight	Flat	Polished	15-8
1005	42, 43	.50	6.00	"	" 2d	"	"	"	Gilded	15-8
1978	129	.60	7.00	"	" 2d	"	"	"	Steel	15-8
1978	128, 129	.50	5.00	"	" 2d	"	"	"	Gilded	15-8
1561	44	.60	7.00	12	" 1st	"	"	"	Polished	15-8
1005	44, 45	.50	6.00	"	" 2d, 3d	"	"	"	Gilded	15-8
2113	67, 68, 71, 72	1.25	15.00	"	" 2d, 3d	"	Cone	Oval	Steel	15-8
1978	68, 72	1.10	13.00	"	" 2d	"	Straight	"	"	15-8
1978	111, 112	.85	10.00	"	" 2d	"	"	Flat	"	15-8
1978	113, 114	.60	7.00	"	" 2d	"	"	"	"	15-8
1978	69, 73	.50	6.00	"	" 2d	"	"	"	Gilded	15-8
1978	70, 74, 111 to 114	.50	5.00	"	" 2d	"	"	"	"	15-8
1906	87, 88, 100, 101	.40	4.00	"	" 2d	"	"	"	"	15-8
2818	135	1.25	15.00	"	" 4th	"	Cone	Oval	Steel	15-8
2798	135	1.15	13.50	"	" 4th	"	Straight	"	"	15-8
1005	46	.60	7.00	10	" 1st	"	"	Flat	Polished	15-8
1005	47, 48	.50	6.00	"	" 1st	"	"	"	Gilded	15-8
1562	49, 50	.60	7.00	6	" 1st	"	"	"	Polished	15-8
1006	50, 51	.50	6.00	"	" 1st	"	"	"	Gilded	15-8
1006	52, 75	.40	4.00	"	" 1st, 2d	"	"	"	"	15-8
2366	53, 54	.60	7.00	"	" 2d	"	"	"	Polished	15-7
1495	53, 54	.70	8.00	"	" 2d	"	"	"	Steel	15-8
1495	55	.50	6.00	"	" 2d	"	"	"	Gilded	15-8
1495	115	.50	5.00	"	" 2d	"	"	"	"	15-8
1495	56	.40	4.00	"	" 2d	"	"	"	"	15-8
1007	57, 58	.60	7.00	0	" 1st	"	"	"	Polished	15-7
1007	59	.50	6.00	"	" 1st	"	"	"	Gilded	15-7
1007	60, 84	.40	4.00	"	" 1st	"	"	"	"	15-7
2367	57, 58	.70	8.00	"	" 1st	"	"	"	Steel	15-7
1979	76, 80	1.10	13.00	"	" 2d, 3d	"	"	Oval	"	15-7
1979	77, 81	.70	8.00	"	" 2d, 3d	"	"	Flat	"	15-7
1979	116, 117	.50	5.00	"	" 2d, 3d	"	"	"	Gilded	15-7
1979	78, 79, 82, 83, 85, 86	.40	4.00	"	" 2d, 3d	"	"	"	"	15-7
2069	133, 136	.50	6.00	5/0	" 1st, 2d	"	"	"	"	15-7
2069	96	1.10	13.00	10/0	" 1st	"	"	Oval	Steel	15-7
2069	97	.50	6.00	"	" 1st	"	"	Flat	Gilded	15-7

No. 994, 995, 1491, 2337, 2338, 2812



Htg. or O. F.

No. 998



Htg.

No. 999, 1492



Htg. or O. F.

No. 1005, 1560, 1561



Htg.

No. 1006, 1495, 1562, 2366



Htg.

No. 1007, 1979, 2367



Htg. or O. F.

No. 1493, 1494, 2169



Htg. or O. F.

No. 1906, 1978



Htg. or O. F.

No. 1976, 1977, 2782, 2783



Htg. or O. F.

No. 2069



Htg. or O. F.

No. 2113



Htg. or O. F.

No. 2798



O. F.

No. 2818



O. F.

WHEELS, FIRST

Catalogue No.	CLASS	PRICE		DESCRIPTION OF MOVEMENT				Teeth
		Piece	Per Doz.	Size	Model			
1932	89, 90, 99	.40	4.00	18	3/4 Pl.	8th, 9th	78	
1932	91	.30	3.00	"	"	8th	78	
2715	41, 98, 126, 132	.40	4.00	16	"	7th, 13th to 15th, 17th	80	
2716	98, 102, 126	.30	3.00	"	"	14th, 15th, 17th	80	
1933	67, 68, 71, 72	.40	4.00	12	"	2d, 3d	78	
2163	69, 70, 73, 74	.30	3.00	"	"	"	78	
1934	76, 80	.40	4.00	0	"	"	76	
1934	77 to 79, 81 to 83, 85, 86	.30	3.00	"	"	"	76	

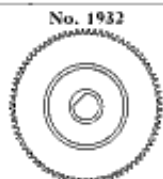

No. 1932
Htg. or O. F.



No. 1933, 2163
Htg. or O. F.



No. 1934
Htg. or O. F.



No. 2715-2716
Htg. or O. F.

WHEELS, FOURTH

Catalogue No.	CLASS	PRICE		DESCRIPTION OF MOVEMENT				Train	Finish	Teeth
		Piece	Per Doz.	Size	Model					
1008	1 to 4, 7 to 9, 65, 66, 118 to 121	.20	2.00	18	P. Pl.	1st to 5th, 7th, 10th, 11th	Quick	Flat	Gilded	80
1008	5, 6, 10, 11, 61 to 64, 103 to 106, 122 to 124	.15	1.50	"	"	1st to 5th, 7th	"	"	"	80
1009	3, 4	.20	2.00	"	"	1st to 4th	Slow	"	"	63
1009	5, 6	.15	1.50	"	"	"	"	"	"	63
1019	12 to 14	.20	2.00	"	3/4 Pl.	6th	Quick	"	"	80
2081	89 to 91, 99, 104	.40	4.00	"	"	8th, 9th	"	Oval	Polished	80
2081	130, 131	.20	2.00	"	"	"	"	Flat	Gilded	80
1012	15	.15	1.50	17	F. Pl.	1st, 2d	Slow	"	"	63
1019	16, 21, 32, 36, 37, 41, 98, 102, 125, 126, 132	.40	4.00	16	3/4 Pl.	1st, 2d, 6th to 9th, 13th to 15th, 17th	Quick	Oval	Polished	80
1019	17 to 19, 22 to 25, 27 to 30	.20	2.00	"	"	1st to 5th	"	Flat	Gilded	80
1019	33, 34, 38, 39, 102	.20	2.00	"	"	6th, 7th, 9th	"	"	"	80
1019	20, 26, 31, 35, 40, 92 to 95, 107 to 110, 127	.15	1.50	"	"	1st, 3d, 5th to 7th, 9th	"	"	"	80
1019	42, 43	.20	2.00	14	"	1st	"	"	"	80
1930	128, 129	.15	1.50	"	"	2d	"	"	"	80
1019	44, 45	.20	2.00	12	"	1st	"	"	"	80
1930	67, 68, 71, 72	.40	4.00	"	"	2d, 3d	"	Oval	Polished	80
1930	69, 73	.20	2.00	"	"	"	"	Flat	Gilded	80
1930	70, 74, 87, 88, 100, 101, 111 to 114	.15	1.50	"	"	"	"	"	"	80
2785	135	.40	4.00	"	"	4th	"	Oval	Polished	80
1019	46 to 48	.20	2.00	10	"	1st	"	Flat	Gilded	80
2377	53, 54	.40	4.00	4	"	2d	"	Oval	Polished	80
1019	49	.30	3.00	"	"	1st	"	Flat	"	80
1019	50, 51, 54, 55	.20	2.00	"	"	1st, 2d	"	"	Gilded	80
1019	52, 56, 75, 115	.15	1.50	"	"	"	"	"	"	80
2178	57, 58, 76, 77, 80, 81	.40	4.00	0	"	1st to 3d	"	Oval	Polished	70
1993	57	.30	3.00	"	"	1st	"	Flat	"	70
1021	58, 59	.20	2.00	"	"	"	"	"	Gilded	70
1021	60, 78, 79, 82 to 86, 116, 117	.15	1.50	"	"	1st to 3d	"	"	"	70
1931	133, 126	.20	2.00	5/0	"	1st, 2d	"	"	"	70
1931	96	.30	3.00	10/0	"	1st	"	"	Polished	70
1931	97	.20	2.00	"	"	"	"	"	Gilded	70



No. 1008
Htg. or O. F.



No. 1009
Htg.



No. 1012
Htg.



No. 1019, 1930, 2377
Htg. or O. F.



No. 1021, 2178
Htg. or O. F.



No. 1931
Htg. or O. F.



No. 1993
Htg. or O. F.



No. 2081
Htg. or O. F.



No. 2785
O. F.

WHEELS, FOURTH AND PINION

Catalogue No.	Class	Price		Description of Movement			Train	Wheel		Teeth
		Piece	Per Doz.	Size	Model					
1022	1 to 4, 118, 119	.50	6.00	18	F. Pl.	1st to 4th, 10th	Quick	Flat	Gilded	80-10
1022	103, 105, 123	.45	4.50	"	"	2d to 4th	"	"	"	80-10
1022	5, 6, 61, 62	.40	4.00	"	"	1st to 4th	"	"	"	80-10
1023	3, 4	.50	6.00	"	"	"	Slow	"	"	63-8
1023	5, 6	.40	4.00	"	"	"	"	"	"	63-8
1024	7 to 9, 65, 66, 120, 121	.50	6.00	"	"	5th, 7th, 11th	Quick	"	"	80-10
1024	104, 106, 122, 124	.45	4.50	"	"	5th, 7th	"	"	"	80-10
1024	10, 11, 63, 64	.40	4.00	"	"	5th	"	"	"	80-10
1025	12 to 14	.50	6.00	"	3/4 Pl.	6th	"	"	"	80-10
1983	89 to 91, 134	.75	9.00	"	"	8th	"	Oval	Polished	80-10
1983	131	.50	6.00	"	"	"	"	Flat	Gilded	80-10
2127	99	.75	9.00	"	"	9th	"	Oval	Polished	80-10
2127	130	.50	6.00	"	"	"	"	Flat	Gilded	80-10
1026	15	.40	4.00	17	F. Pl.	1st, 2d	Slow	"	"	63-8
1027	16, 21	.70	8.00	16	3/4 Pl.	"	Quick	Oval	Polished	80-10
1027	17 to 20, 22 to 25	.50	6.00	"	"	1st to 3d	"	Flat	Gilded	80-10
657	36	.75	9.00	"	"	6th	"	Oval	Polished	80-10
657	32, 125, 126	.70	8.00	"	"	6th, 8th, 14th, 17th	"	"	"	80-10
657	33, 34	.50	6.00	"	"	6th	"	Flat	Gilded	80-10
657	107, 109	.45	4.50	"	"	"	"	"	"	80-10
657	26, 35, 92, 93	.40	4.00	"	"	3d, 6th	"	"	"	80-10
1030	41, 132	.75	9.00	"	"	7th, 15th	"	Oval	Polished	80-10
1030	37, 98, 102	.70	8.00	"	"	7th, 9th, 13th, 15th	"	"	"	80-10
1030	29, 30, 38, 39, 102	.50	6.00	"	"	5th, 7th, 9th	"	Flat	Gilded	80-10
1030	108, 110, 127	.45	4.50	"	"	7th, 9th	"	"	"	80-10
1030	31, 40, 94, 95	.40	4.00	"	"	5th, 7th	"	"	"	80-10
1031	27, 28	.50	6.00	"	"	4th	"	"	"	80-10
1033	42, 43	.50	6.00	14	"	1st	"	"	"	80-10
1985	128, 129	.45	4.50	"	"	2d	"	"	"	80-10
1023	44, 45	.50	6.00	12	"	1st	"	"	"	80-10
1984	67	.75	9.00	"	"	2d	"	Oval	Polished	80-10
1984	68	.70	8.00	"	"	"	"	"	"	80-10
1984	69	.50	6.00	"	"	"	"	Flat	Gilded	80-10
1984	111, 113	.45	4.50	"	"	"	"	"	"	80-10
1984	70, 87, 100	.40	4.00	"	"	"	"	"	"	80-10
1985	71	.75	9.00	"	"	3d	"	Oval	Polished	80-10
1985	72	.70	8.00	"	"	"	"	"	"	80-10
1985	73	.50	6.00	"	"	"	"	Flat	Gilded	80-10
1985	112, 114	.45	4.50	"	"	"	"	"	"	80-10
1985	74, 88, 101	.40	4.00	"	"	"	"	"	"	80-10
2786	135	.75	9.00	"	"	4th	"	Oval	Polished	80-10
1033	46 to 48	.50	6.00	10	"	1st	"	Flat	Gilded	80-10
2376	53, 54	.70	8.00	6	"	2d	"	Oval	Polished	80-10
1034	49	.60	7.00	"	"	1st	"	Flat	"	80-10
1034	50, 51, 54, 55	.50	6.00	"	"	1st, 2d	"	"	Gilded	80-10
1034	115	.45	4.50	"	"	2d	"	"	"	80-10
1034	52, 56, 75	.40	4.00	"	"	1st, 2d	"	"	"	80-10
2368	57, 58	.70	8.00	0	"	1st	"	Oval	Polished	70-10
1035	57	.60	7.00	"	"	"	"	Flat	"	70-10
1035	58, 59	.50	6.00	"	"	"	"	"	Gilded	70-10
1035	60, 84	.40	4.00	"	"	"	"	"	"	70-10
1986	76, 77	.70	8.00	"	"	2d	"	Oval	Polished	70-10
1986	116	.45	4.50	"	"	"	"	Flat	Gilded	70-10
1986	78, 79, 85	.40	4.00	"	"	"	"	"	"	70-10
1987	80, 81	.70	8.00	"	"	3d	"	Oval	Polished	70-10
1987	117	.45	4.50	"	"	"	"	Flat	Gilded	70-10
1987	82, 83, 86	.40	4.00	"	"	"	"	"	"	70-10
2118	133, 136 Long Pivot	.60	7.00	5/0	"	1st, 2d	"	"	"	70-8
2123	133, 136 Short	.60	7.00	"	"	"	"	"	"	70-8
2118	96 Long	.70	8.00	10/0	"	1st	"	"	Polished	70-8
2118	97	.60	7.00	"	"	"	"	"	Gilded	70-8
2123	96 Short	.70	8.00	"	"	"	"	"	Polished	70-8
2123	97	.60	7.00	"	"	"	"	"	Gilded	70-8

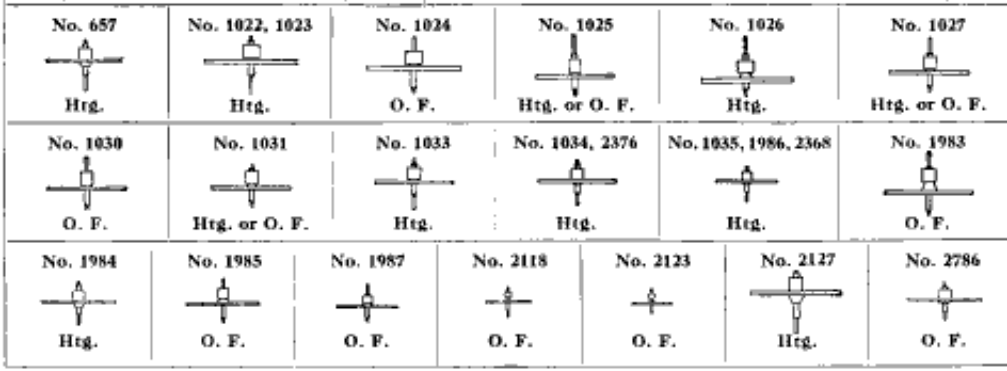









WHEELS, HOUR

Catalogue No.	CLASS	PRICE		DESCRIPTION OF MOVEMENT		Finish	Teeth
		Piece	Per Doz.	Size	Model		
1036	1 to 6, 61, 119	10	1.00	18	F. Pl. 1st to 4th, 10th	Nickel	48
40	1 to 5	10	1.00	"	" 2d to 4th	"	48
59	4 to 6, 61, 62, 103, 105, 118, 123	10	1.00	"	" 2d to 4th, 10th	"	48
186	7 to 11, 63 to 66, 104, 106, 120 to 122, 124	10	1.00	"	" 6th, 7th, 11th	"	48
1037	12 to 14	10	1.00	"	3/4 Pl. 6th	Gilded	40
1035	89, 90, 99	15	1.50	"	" 8th, 9th	Nickel	40
1035	91, 130, 131, 134	10	1.00	"	"	"	48
1036	15	10	1.00	17	F. Pl. 1st	Gilded	48
40	15	10	1.00	"	" 2d	"	48
1043	16, 21	50	6.00	16	3/4 Pl. 1st, 2d	Steel	40
1043	17 to 20, 22, 23	10	1.00	"	"	Gilded	40
140	24 to 26, 29 to 31, 35, 40	10	1.00	"	" 3d, 5th to 7th	"	40
1041	27, 28	10	1.00	"	" 4th	"	40
1496	36, 41, 98, 132	15	1.50	"	" 6th, 7th, 13th, 15th	Nickel	40
1496	32 to 34, 37 to 39, 98, 102, 125 to 127	15	1.25	"	" 6th, 7th, 9th, 13th to 15th,	"	40
					" 17th	"	40
1496	35, 40, 92 to 95, 107 to 110	10	1.00	"	" 6th, 7th	"	40
1043	42, 43	10	1.00	14	" 1st	Gilded	40
2710	128, 129	10	1.00	"	" 2d	Nickel	40
2090	128, 129	10	1.00	"	"	"	40
2170	44, 45	10	1.00	12	" 1st	Gilded	40
1936	67, 71	15	1.50	"	" 2d, 3d	Nickel	40
1936	68, 69, 72, 73	15	1.25	"	"	"	40
1936	70, 74, 87, 88, 100, 101, 111 to 114	10	1.00	"	"	"	40
2819	113, 114	10	1.00	"	"	"	40
2787	135	15	1.50	"	" 4th	"	40
2170	46 to 48	10	1.00	10	" 1st	Gilded	40
1044	49 to 52	10	1.00	6	"	"	40
1937	53 to 56, 75, 115	10	1.00	"	" 2d	"	40
1045	57 to 60, 76 to 86, 116, 117	10	1.00	0	" 1st to 3d	Nickel	32
*2961	116, 117	10	1.00	"	" 2d, 3d	"	32
2883	81, 116, 117	10	1.00	0x12	"	"	32
1938	133	10	1.00	5/0	" 1st	"	32
2820	133, 136	10	1.00	"	" 1st, 2d	"	32
1938	96, 97	10	1.00	10/0	" 1st	"	32
2820	96, 97	10	1.00	"	"	"	32







*Two lengths of hubs have been used in the hour wheels of 0 size 2d and 3d model watches. No. 2961 is the shorter and is also used in 2/0 size 2d and 3d model watches. In ordering 0 size hour wheels send sample or specify which number is wanted.

†Used in 12 Size 2d and 3d Model spread to 16.

No. 40, 186, 1036  Htg. or O. F.	No. 59, 1037  Htg. or O. F.	No. 140, 1041, 1496  Htg. or O. F.	No. 1043, 1937, 2170  Htg. or O. F.
No. 1044, 1936, 2710 2787, 2819, 2990  Htg. or O. F.	No. 1045, 2883, 2961  Htg. or O. F.	No. 1935  Htg. or O. F.	No. 1938, 2820  Htg. or O. F.

WHEELS, INTERMEDIATE SETTING

Catalogue No.	CLASS	PRICE		DESCRIPTION OF MOVEMENT		Finish	Teeth
		Piece	Per Doz.	Size	Model		
58	4, 5, 118, 123	10	1.00	18	F. Pl. 2d to 4th, 10th	Steel	13
58	6, 61, 62, 103, 106	10	.75	"	" 2d to 4th	Gilded	13
79	15	10	1.00	17	" 2d	Steel	21
137	24 to 28	15	1.50	16	3/4 Pl. 3d, 4th	"	20
150	52	10	1.00	0	" 1st	"	18
110	49 to 51	10	1.00	"	" 2d	"	18
1497	53 to 56	10	1.00	"	" 2d	"	14
2720	133, 136	10	1.00	5/0	" 1st, 2d	"	10

No. 58  Htg.	No. 79  Htg.	No. 110  Htg.	No. 137  Htg. or O. F.	No. 156  Htg.	No. 1497  Htg.	No. 2720  Htg. or O. F.
---	---	--	---	--	---	--

WHEELS, INTERMEDIATE WINDING

Catalogue No.	Class	PRICE		DESCRIPTION OF MOVEMENT			Teeth
		Piece	Per Doz.	Size	Model		
38	1	.15	1.50	18	F. Pl.	2d to 4th	26
38	2 to 5	.10	1.00	"	"	"	26
38	6, 61, 62, 103, 103, 118, 119, 123	.10	.75	"	"	2d to 4th, 10th	26
177	7, 65	.13	1.50	"	"	5th, 7th	17
177	8, 9, 66	.10	1.00	"	"	"	17
177	10, 11, 63, 64, 104, 106, 120 to 122, 124	.10	.75	"	"	5th, 7th, 11th	17
78	15	.10	1.00	17	"	2d	30
136	24 to 28	.10	1.00	16	3/4 Pl.	3d, 4th	28
1047	29 to 31	.10	1.00	"	"	5th	20
109	49 to 51, 53 to 55	.10	1.00	6	"	1st, 2d	30
109	52, 56, 75, 115	.10	.75	"	"	"	30
1049	57 to 59	.10	1.00	9	"	1st	25
1049	60, 84	.10	.75	"	"	"	25

No. 38



Htg.

No. 78



Htg.

No. 109



Htg.

No. 136



Htg. or O. F.

No. 177



O. F.

No. 1047



O. F.

No. 1049



Htg.

WHEELS, MINUTE

Catalogue No.	Class	PRICE		DESCRIPTION OF MOVEMENT			Teeth
		Piece	Per Doz.	Size	Model		
1055	1 to 6, 61, 119	.10	1.00	18	F. Pl.	1st to 4th, 10th	Nickel 42-12
1062	4 to 6, 61, 62, 103, 105, 118, 123	.10	1.00	"	"	2d to 4th, 10th	" 36-10
187	7 to 11, 63 to 66, 104, 106, 120 to 122, 124	.15	1.25	"	"	5th, 7th, 11th	Steel 36-12
1062	12 to 14	.10	1.00	"	3/4 Pl.	6th	Gilded 36-10
1945	89, 90, 99	.20	2.00	"	"	8th, 9th	Steel 36-10
1945	91, 130, 131, 134	.10	1.00	"	"	"	Nickel 36-10
1945	90	.15	1.50	"	"	8th	" 36-10
1035	15	.10	1.00	17	F. Pl.	1st, 2d	Gilded 42-12
1061	16, 21	.50	6.00	16	3/4 Pl.	"	Steel 36-10
1061	17 to 20, 22, 23	.10	1.00	"	"	"	Gilded 36-10
1062	24 to 31	.10	1.00	"	"	3d to 5th	" 36-10
1499	36, 41, 98, 132	.20	2.00	"	"	6th, 7th, 13th, 15th	Steel 36-10
1499	32 to 34, 37 to 39, 98, 102, 126	.15	1.50	"	"	6th, 7th, 9th, 13th, 15th	" 36-10
1499	35, 40, 92 to 95, 107 to 110, 125, 127	.15	1.25	"	"	17th	" 36-10
1061	42, 43	.10	1.00	14	"	6th to 9th	" 36-10
1946	128, 129	.15	1.25	"	"	1st	Gilded 36-10
1061	44, 45	.10	1.00	12	"	2d	Steel 36-10
1946	67, 71	.20	2.00	"	"	1st	Gilded 36-10
1946	68, 69, 72, 73	.15	1.50	"	"	2d, 3d	Steel 36-10
1946	70, 74, 87, 88, 100, 101, 111 to 114	.15	1.25	"	"	"	" 36-10
2800	135	.15	1.50	"	"	4th	Nickel 36-10
1061	46 to 48	.10	1.00	10	"	1st	Gilded 36-10
1062	49 to 52	.10	1.00	6	"	"	" 36-10
1509	53 to 56, 75, 115	.10	1.00	"	"	2d	Nickel 36-10
1063	57 to 60, 78 to 86, 116, 117	.10	1.00	9	"	1st to 3d	" 30-8
1947	133, 136	.10	1.00	5/0	"	1st, 2d	" 30-8
1947	96, 97	.10	1.00	10/0	"	1st	" 30-8

No. 187



O. F.

No. 1055



Htg.

No. 1061



Htg. or O. F.

No. 1062, 1499, 1946



Htg. or O. F.

No. 1063



Htg. or O. F.

No. 1500



Htg.

No. 1945



Htg. or O. F.

No. 1947



Htg. or O. F.

No. 2800



O. F.

To ascertain Grade of Movement, consult Index. In ordering Material, give Catalogue Number and Class, or Number of Movement for which same is required.

WHEELS, MAIN

Used with Exposed Winding Wheels

Owing to the many different styles of finish on the main wheels of our exposed winding wheel models, it has become necessary to abandon the previous system of classifying them. We now list them in four general divisions. In each of these divisions are noted the chief features of the finishes embraced by them which serves in a general way as a guide for ordering.

Catalogue No.	PRICE		DESCRIPTION OF MOVEMENT		Teeth	In ordering specify letter in addition to catalogue number	
	Piece	Per Doz.	Size	Model			
1941	.85	10.00	18	3/4 Pl. 8th, 9th	41-32	A. Face polished or rayed and damaskeened, cupped center, corners polished	
1498	.85	10.00	16	" 6th to 9th, 13th to 15th, 17th	48-24		
2722	.85	10.00	14	" 2d	51-32		
1942	.85	10.00	12	" 2d, 3d	51-32		
2799	.85	10.00	"	" 4th	51-32		
1943	.85	10.00	0	" 2d, 3d	38-30	B. Face polished or rayed, cupped center, corners polished	
2724	.85	10.00	5/0	" 1st, 2d	35-28		
1944	.85	10.00	10/0	" 1st	30-24		
1941	.70	8.00	18	" 8th, 9th	41-32		C. Face polished and damaskeened, corners polished
1498	.70	8.00	16	" 6th to 9th, 13th to 15th, 17th	48-24		
2722	.70	8.00	14	" 2d	51-32		
1942	.70	8.00	12	" 2d, 3d	51-32		
2799	.70	8.00	"	" 4th	51-32		
1943	.70	8.00	0	" 2d, 3d	38-30	D. Face rayed and damaskeened, corners polished	
2724	.70	8.00	5/0	" 1st, 2d	35-28		
1944	.70	8.00	10/0	" 1st	30-24		
1498	.50	6.00	16	" 6th to 9th, 13th to 15th, 17th	48-24		E. Face polished and rayed, corners polished
2722	.50	6.00	14	" 2d	51-32		
1942	.50	6.00	12	" 2d, 3d	51-32		
2799	.50	6.00	"	" 4th	51-32		
1943	.50	6.00	0	" 2d, 3d	38-30	F. Face polished and rayed, corners ground	
2724	.50	6.00	5/0	" 1st, 2d	35-28		
1944	.50	6.00	10/0	" 1st	30-24		
1498	.40	4.00	16	" 6th to 9th, 13th to 15th, 17th	48-24		G. Face rayed, corners polished
2722	.40	4.00	14	" 2d	51-32		
1942	.40	4.00	12	" 2d, 3d	51-32		
1943	.40	4.00	0	"	38-30		
2724	.40	4.00	5/0	" 1st, 2d	35-28	H. Face rayed, corners ground	
1944	.40	4.00	10/0	" 1st	30-24		
1498	.40	4.00	16	" 6th to 9th, 13th to 15th, 17th	48-24		I. Face rayed
2722	.40	4.00	14	" 2d	51-32		
1942	.40	4.00	12	" 2d, 3d	51-32		
1943	.40	4.00	0	"	38-30		
2724	.40	4.00	5/0	" 1st, 2d	35-28		
1944	.40	4.00	10/0	" 1st	30-24		

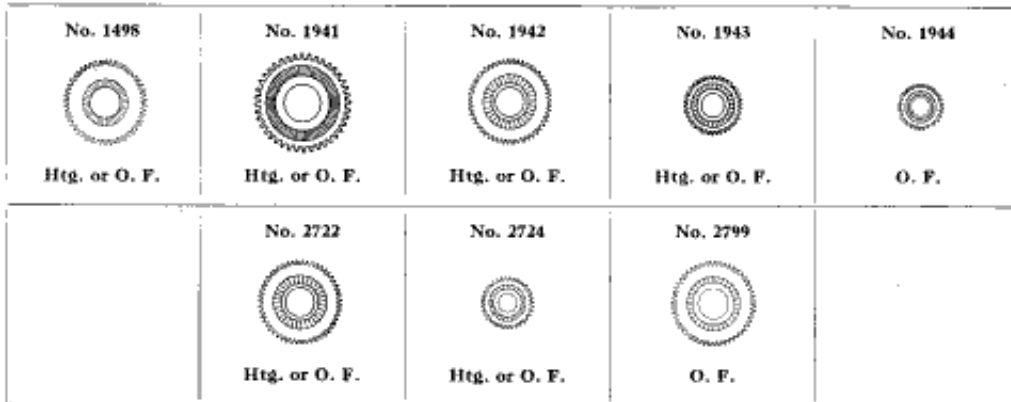

In ordering main wheels for watches having exposed winding wheels give catalogue number and letter.

To assure receiving main wheels with the same finish as the original, send sample.

The several kinds of main wheel finishes described are not made for all sizes and models.

Only such finishes as have been used in a particular model and grade can be supplied for that grade.

Read the introduction page carefully, as it explains fully our system of cataloguing.

Orders for less than one-fourth dozen pieces of a kind will be charged for at the single-piece price.

WHEELS, MAIN

Catalogue No.	CLASS	PRICE		DESCRIPTION OF MOVEMENT			Teeth
		Piece	Per Doz.	Size	Model		
36	1 to 5.....	.50	5.00	18	F. Pl.	2d to 4th	40-32
113	1 to 5, 119.....	.40	4.00	"	"	2d to 4th, 10th	40
56	4, 5, 118.....	.30	3.00	"	"	"	40
65	6, 61, 62, 103, 105, 123.....	.15	1.50	"	"	2d to 4th	40
175	7 to 11, 63 to 66, 104, 106, 120 to 122, 124.....	.15	1.50	"	"	5th, 7th, 11th	32
93	12 to 14.....	.40	4.00	"	$\frac{3}{4}$ Pl.	6th	34
77	15.....	.30	3.00	17	F. Pl.	2d	40
93	16 to 23.....	.40	4.00	16	$\frac{3}{4}$ Pl.	1st, 2d	34
135	24 to 31.....	.15	1.50	"	"	3d to 5th	42
107	49 to 51.....	.40	4.00	6	"	1st	35
154	52 to 56, 75, 115.....	.15	1.50	"	"	1st, 2d	35
1054	57 to 60, 84.....	.15	1.50	0	"	1st	40

No. 36



Htg.

No. 56, 77



Htg.

No. 65



Htg.

No. 93



Htg. or O. F.

No. 107



Htg.

No. 113



Htg.

No. 135



Htg. or O. F.

No. 154



Htg.

No. 175



O. F.

No. 1054



Htg.

For main wheels used on models having exposed winding wheels see the preceding page.

WHEELS, RATCHET

Catalogue No.	CLASS	PRICE		DESCRIPTION OF MOVEMENT			Teeth
		Piece	Per Doz.	Size	Model		
39	1.....	.20	2.00	18	F. Pl.	2d to 4th	40
39	2 to 5.....	.15	1.50	"	"	"	40
39	6, 10, 11, 61 to 64, 103 to 106, 118 to 121.....	.10	1.00	"	"	2d to 5th, 10th, 11th	40
1064	7, 65.....	.20	2.00	"	"	5th, 7th	40
1064	4, 5, 8, 9, 66, 122, 124.....	.10	1.00	"	"	2d to 5th, 7th	40
94	12 to 14.....	1.00	12.00	"	$\frac{3}{4}$ Pl.	6th	63-24
39	15.....	.40	4.00	17	F. Pl.	2d	40
94	16 to 23.....	1.00	12.00	16	$\frac{3}{4}$ Pl.	1st, 2d	63-24
139	24, 25, 27 to 30.....	.15	1.50	"	"	3d to 5th	48
139	26, 31.....	.10	1.00	"	"	3d, 5th	48
108	49 to 51, 53 to 55.....	.15	1.50	6	"	1st, 2d	40
108	52, 56, 75, 115.....	.10	1.00	"	"	"	40
1069	57 to 59.....	.15	1.50	0	"	1st	45
1069	60, 84.....	.10	1.00	"	"	"	45

No. 39, 1064



Htg. or O. F.

No. 94



Htg. or O. F.

No. 108



Htg.

No. 139



Htg. or O. F.

No. 1069



Htg.

For ratchet wheels used on models having exposed winding wheels see the following page.

WHEELS, RATCHET

Used on Models having Exposed Winding Wheels

Owing to the many different styles of finish on the ratchet wheels of our exposed winding wheel models, it has become necessary to abandon the previous system of classifying them. We now list them in four general divisions. In each of these divisions are noted the chief features of the finishes embraced by them which serves in a general way as a guide for ordering.

Catalogue No.	Price		DESCRIPTION OF MOVEMENT		Teeth	In ordering, specify letter in addition to catalogue number	
	Piece	Per Doz.	Size	Model			
1950	.75	9.00	18	3/4 Pl. 8th, 9th	56	A. Face polished or rayed and damaskened, cupped center, corners polished	
2721	.75	9.00	18	" 8th, 9th	56		
1501	.75	9.00	16	" 6th to 9th, 13th, 15th	74		
2725	.75	9.00	16	" 7th, 13th to 15th, 17th	74		
1718	.75	9.00	14	" 2d	69		
1718	.75	9.00	12	" 2d, 3d	69		
1964	.75	9.00	12	" 4th	69		
2804	.75	9.00	12	" 4th	69		
1951	.75	9.00	0	" 2d, 3d	56		
2058	.75	9.00	0	" 2d, 3d	56		
2727	.75	9.00	5/0	" 1st, 2d	49		
1952	.75	9.00	10/0	" 1st	42		
1950	.60	7.00	18	" 8th, 9th	56	C. Face polished and damaskened, corners polished	
2721	.60	7.00	18	" 8th, 9th	56		
1501	.60	7.00	16	" 6th to 9th, 13th, 15th	74		
2725	.60	7.00	16	" 7th, 13th to 15th, 17th	74		
1718	.60	7.00	14	" 2d	69		
1718	.60	7.00	12	" 2d, 3d	69		
1964	.60	7.00	12	" 4th	69		
2804	.60	7.00	12	" 4th	69		
1950	.60	7.00	0	" 2d, 3d	56		
2058	.60	7.00	0	" 2d, 3d	56		
2727	.60	7.00	5/0	" 1st, 2d	49		
1952	.60	7.00	10/0	" 1st	42		
1501	.50	5.00	16	" 6th to 9th, 13th, 15th	74	E. Face polished and rayed, corners ground	
1718	.50	5.00	14	" 2d	69		
1718	.50	5.00	12	" 2d, 3d	69		
1964	.50	5.00	12	" 4th	69		
2804	.50	5.00	12	" 4th	69		
1951	.50	5.00	0	" 2d, 3d	56		
2058	.50	5.00	0	" 2d, 3d	56		
2727	.50	5.00	5/0	" 1st, 2d	49		
1952	.50	5.00	10/0	" 1st	42		
1501	.30	3.00	16	" 6th to 9th, 13th, 15th	74		H. Face rayed, corners ground
1718	.30	3.00	14	" 2d	69		
1718	.30	3.00	12	" 2d, 3d	69		
1964	.30	3.00	12	" 4th	69		
1951	.30	3.00	0	" 2d, 3d	56		
2058	.30	3.00	0	" 2d, 3d	56		
2727	.30	3.00	5/0	" 1st, 2d	49		
1952	.30	3.00	10/0	" 1st	42		
1501	.30	3.00	16	" 6th to 9th, 13th, 15th	74	I. Face rayed	
1718	.30	3.00	14	" 2d	69		
1718	.30	3.00	12	" 2d, 3d	69		
1964	.30	3.00	12	" 4th	69		
1951	.30	3.00	0	" 2d, 3d	56		
2058	.30	3.00	0	" 2d, 3d	56		
2727	.30	3.00	5/0	" 1st, 2d	49		
1952	.30	3.00	10/0	" 1st	42		

In ordering ratchet wheels for watches having exposed winding wheels give catalogue number and letter. To assure receiving ratchet wheels with the same finish as the original, send sample. The several kinds of ratchet wheel finishes described are not made for all sizes and models. Only such finishes as have been used in a particular model and grade can be supplied for that grade.

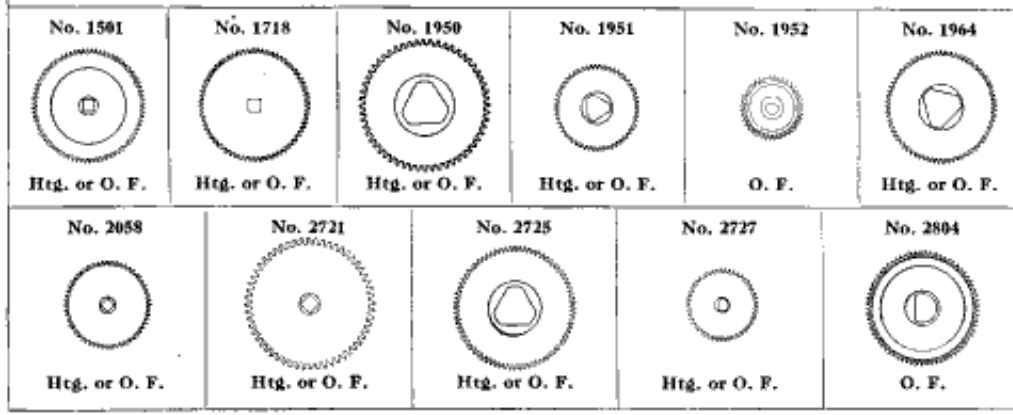

WHEELS, RING

Catalogue No.	CLASS	PRICE		DESCRIPTION OF MOVEMENT		Teeth
		Piece	Per Doz.	Size	Model	
37	1 to 5, 119	.20	2.00	18	F. Pl. 2d to 4th, 10th	32-78

WHEELS, SWEEP SECOND

Catalogue No.	CLASS	PRICE		DESCRIPTION OF MOVEMENT		Finish	Teeth
		Piece	Per Doz.	Size	Model		
1074	27, 28	.40	4.00	18	3/4 Pl. 4th	Flat Polished	90



WHEELS, SETTING

Catalogue No.	CLASS	PRICE		DESCRIPTION OF MOVEMENT		Finish	Teeth
		Piece	Per Doz.	Size	Model		
57	4, 5, 118, 123	.10	1.00	18	F. Pl. 2d to 4th, 10th	Steel	21
57	6, 61, 62, 103, 105	.10	.75	"	" 2d to 4th	Gilded	21
176	7, 65	.20	2.00	"	" 5th, 7th	Steel	16
176	8, 9, 66	.15	1.50	"	" "	"	16
176	10, 11, 120 to 122, 124	.10	1.00	"	" 5th, 7th, 11th	"	16
1953	63, 64, 104, 106	.10	1.00	"	" 5th	"	16
*189	12 to 14	.35	3.50	"	3/4 Pl. 6th	"	36
1939	89, 90, 99	.15	1.50	"	" 8th, 9th	"	20
1939	91, 130, 131, 134	.10	1.00	"	" "	"	20
79	15	.10	1.00	17	F. Pl. 2d	"	21
*95	16 to 23	.35	3.50	16	3/4 Pl. 1st, 2d	"	36
138	24, 25, 27, 28	.10	1.00	"	" 3d, 4th	"	16
138	26	.10	.75	"	" 3d	Gilded	16
1971	29, 30	.10	1.00	"	" 5th	Steel	20
1071	31	.10	.75	"	" "	Gilded	20
2805	135	.15	1.50	12	" 4th	Steel	14
157	52	.15	1.50	6	" 1st	"	14
111	49 to 51	.10	1.00	"	" "	"	14
1502	53 to 55	.10	1.00	"	" 2d	"	22
1302	56, 75, 115	.10	.75	"	" "	Gilded	22
1073	57 to 59	.10	1.00	0	" 1st	Steel	22
1073	60, 84	.10	.75	"	" "	Gilded	22
1940	76, 77, 80, 81	.15	1.50	"	" 2d, 3d	Steel	15
1940	78, 79, 82, 83, 85, 86, 116, 117	.10	1.00	"	" "	"	15
1954	133, 136	.10	1.00	5/0	" 1st, 2d	"	14
1954	96, 97	.10	1.00	10/0	" 1st	"	14

*Not furnished separate from the Arbors, and prices include both Wheel and Arbor.

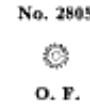
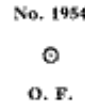
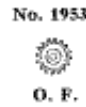
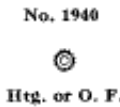
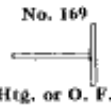
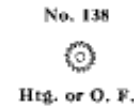
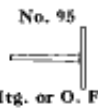

WHEELS, THIRD

Catalogue No.	CLASS	PRICE		DESCRIPTION OF MOVEMENT		Train	Finish	Teeth
		Piece	Per Doz.	Size	Model			
1075	1 to 4, 118, 119	20	2.00	18	F. Pl.	1st to 4th, 10th	Quick Flat	Gilded 75
1075	5, 6, 61, 62, 103, 105, 123	15	1.50	"	"	1st to 4th	Slow "	" 75
1076	3, 4	20	2.00	"	"	"	" "	60
1076	5, 8	15	1.50	"	"	"	" "	60
1077	7 to 9, 65, 66, 120, 121	20	2.00	"	"	5th, 7th, 11th	Quick "	" 75
1077	10, 11, 63, 64, 104, 106, 122, 124	15	1.50	"	"	5th, 7th	" "	" 75
1086	12 to 14	20	2.00	"	3/4 Pl.	6th	" "	" 75
1948	89 to 91, 99, 134	40	4.00	"	"	8th, 9th	" Oval	Polished 75
1948	130, 131	20	2.00	"	"	"	Flat Gilded	75
1079	15	15	1.50	17	F. Pl.	1st, 2d	Slow "	" 60
1086	16, 21, 32, 38, 37, 41, 98, 102, 125, 126, 132	40	4.00	16	3/4 Pl.	1st, 2d, 6th to 9th	Quick Oval	Polished 75
1086	17 to 19, 22 to 25, 27 to 30	20	2.00	"	"	13th, 15th, 17th	Flat Gilded	75
1086	33, 34, 35, 39, 102	20	2.00	"	"	1st to 5th	" "	75
1086	20, 26, 31, 35, 40, 92 to 95, 107 to 110, 127	15	1.50	"	"	6th, 7th, 9th	" "	" 75
1086	42, 43	20	2.00	14	"	1st, 3d, 5th to 7th, 9th	" "	" 75
1965	128, 129	15	1.50	"	"	1st	" "	" 75
1086	44, 45	20	2.00	12	"	2d	" "	" 75
1965	67, 68, 71, 72	40	4.00	"	"	1st	" Oval	Polished 75
1965	69, 73	20	2.00	"	"	2d, 3d	Flat Gilded	75
1965	70, 74, 87, 88, 100, 101, 111 to 114	15	1.50	"	"	"	" "	" 75
2806	135	40	4.00	"	"	4th	" Oval	Polished 75
1086	46 to 48	20	2.00	10	"	1st	" Flat	Gilded 75
1086	53, 54	40	4.00	6	"	2d	" Oval	Polished 75
1086	49	30	3.00	"	"	1st	" Flat	" 75
1086	50, 51, 54, 55	20	2.00	"	"	1st, 2d	" "	Gilded 75
1086	52, 56, 75, 115	15	1.50	"	"	"	" "	" 75
2173	57, 58, 76, 77, 80, 81	40	4.00	0	"	1st to 3d	" Oval	Polished 75
1088	57	30	3.00	"	"	1st	" Flat	" 75
1088	58, 59	20	2.00	"	"	"	" "	Gilded 75
1088	60, 78, 79, 82 to 86, 116, 117	15	1.50	"	"	1st to 3d	" "	" 75
1949	133, 136	20	2.00	5/0	"	1st, 2d	" "	" 60
1949	96	30	3.00	10/0	"	1st	" "	Polished 60
1949	97	20	2.00	"	"	"	" "	Gilded 60

No. 1075, 1077



Htg. or O. F.

No. 1076



Htg.

No. 1079



Htg.

No. 1086



Htg. or O. F.

No. 1088, 2173



Htg. or O. F.

No. 1948



Htg. or O. F.

No. 1949



O. F.

No. 1965, 2806



Htg. or O. F.

Orders for one-fourth dozen pieces of a kind will be charged at the single piece price.

Your Jobber will supply Balance Staffs, Balance Jewels, Roller Jewels. Hands and Screws in Dozen lots in original sealed trade marked Packages.



[TOP]

TRADE-MARKED PACKAGE



[BOTTOM]

WHEELS, THIRD AND PINION



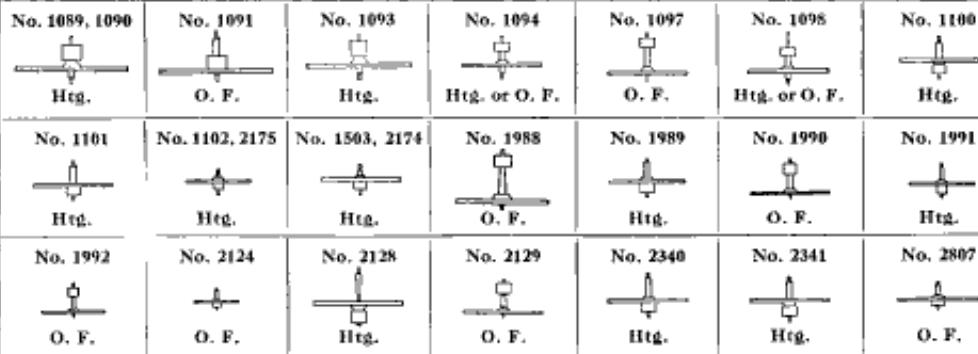









Catalogue No.	CLASS	PRICE		DESCRIPTION OF MOVEMENT		Train	Wheel		Teeth	
		Piece	Per Doz.	Size	Model					
1089	1 to 4, 118, 119	.50	6.00	18	F. Pl.	1st to 4th, 10th	Quick	Flat	Gilded	75-10
1089	103, 105, 123	.45	4.50	"	"	2d to 4th	"	"	"	75-10
1089	5, 6, 61, 62	.40	4.00	"	"	1st to 4th	"	"	"	75-10
1090	3, 4	.50	6.00	"	"	"	Slow	"	"	60-8
1090	5, 6	.40	4.00	"	"	"	"	"	"	60-8
1091	7 to 9, 65, 66, 120, 121	.50	6.00	"	"	5th, 7th, 11th	Quick	"	"	75-10
1091	104, 106, 122, 124	.45	4.50	"	"	5th, 7th	"	"	"	75-10
1091	10, 11, 63, 64	.40	4.00	"	"	5th	"	"	"	75-10
1094	12 to 14	.60	6.00	"	3/4 Pl.	6th	"	"	"	75-10
1988	89 to 91, 134	.75	9.00	"	"	8th	"	Oval	Polished	75-10
1988	131	.50	6.00	"	"	"	"	Flat	Gilded	75-10
2128	99	.75	9.00	"	"	9th	"	Oval	Polished	75-10
2128	130	.50	6.00	"	"	"	"	Flat	Gilded	75-10
1093	15	.40	4.00	17	F. Pl.	1st, 2d	Slow	"	"	60-8
1094	16, 21	.70	8.00	16	3/4 Pl.	"	Quick	Oval	Polished	75-10
1094	17 to 20, 22 to 25	.50	6.00	"	"	1st to 3d	"	Flat	Gilded	75-10
2341	26	.40	4.00	"	"	3d	"	"	"	75-10
1098	27, 28	.50	6.00	"	"	4th	"	"	"	75-10
2340	30	.75	9.00	"	"	6th	"	Oval	Polished	75-10
2340	32, 125, 126	.70	8.00	"	"	6th, 8th, 14th, 17th	"	"	"	75-10
2340	33, 34	.50	6.00	"	"	6th	"	Flat	Gilded	75-10
2340	107, 109	.45	4.50	"	"	"	"	"	"	75-10
2340	35, 92, 93	.40	4.00	"	"	"	"	"	"	75-10
1097	41, 132	.75	9.00	"	"	7th, 15th	"	Oval	Polished	75-10
1097	37, 98, 102	.70	8.00	"	"	7th, 9th, 13th, 15th	"	"	"	75-10
1097	29, 30, 38, 39, 102	.50	6.00	"	"	5th, 7th, 9th	"	Flat	Gilded	75-10
1097	108, 110, 127	.45	4.50	"	"	7th, 9th	"	"	"	75-10
1097	31, 40, 94, 95	.40	4.00	"	"	5th, 7th	"	"	"	75-10
1100	42, 43	.50	6.00	14	"	1st	"	"	"	75-10
1090	128, 129	.45	4.50	"	"	2d	"	"	"	75-10
1100	44, 45	.50	6.00	12	"	1st	"	"	"	75-10
1989	67	.75	9.00	"	"	2d	"	Oval	Polished	75-10
1989	68	.70	8.00	"	"	"	"	"	"	75-10
1989	69	.50	6.00	"	"	"	"	Flat	Gilded	75-10
1989	111, 113	.45	4.50	"	"	"	"	"	"	75-10
1989	70, 87, 100	.40	4.00	"	"	"	"	"	"	75-10
2129	71	.75	9.00	"	"	3d	"	Oval	Polished	75-10
1990	72	.70	8.00	"	"	"	"	"	"	75-10
1990	73	.50	6.00	"	"	"	"	Flat	Gilded	75-10
1990	112, 114	.45	4.50	"	"	"	"	"	"	75-10
1990	74, 88, 101	.40	4.00	"	"	"	"	"	"	75-10
2807	135	.75	9.00	"	3/4 Pl.	4th	"	Oval	Polished	75-10
1100	46 to 48	.50	6.00	10	"	1st	"	Flat	Gilded	75-10
2174	53, 54	.70	8.00	6	"	2d	"	Oval	Polished	75-10
1101	49	.60	7.00	"	"	1st	"	Flat	"	75-10
1101	50, 51	.50	6.00	"	"	"	"	"	Gilded	75-10
1101	52	.40	4.00	"	"	"	"	"	"	75-10
1503	54, 55	.50	6.00	"	"	2d	"	"	"	75-10
1503	115	.45	4.50	"	"	"	"	"	"	75-10
1503	56, 75	.40	4.00	"	"	"	"	"	"	75-10
2175	57, 58	.70	8.00	0	"	1st	"	Oval	Polished	75-10
1102	57	.60	7.00	"	"	"	"	Flat	"	75-10
1102	58, 59	.50	6.00	"	"	"	"	"	Gilded	75-10
1102	60, 84	.40	4.00	"	"	"	"	"	"	75-10
1991	76, 77	.70	8.00	"	"	2d	"	Oval	Polished	75-10
1991	116	.45	4.50	"	"	"	"	Flat	Gilded	75-10
1991	78, 79, 85	.40	4.00	"	"	"	"	"	"	75-10
1992	80, 81	.70	8.00	"	"	3d	"	Oval	Polished	75-10
1992	117	.45	4.50	"	"	"	"	Flat	Gilded	75-10
1992	82, 83, 86	.40	4.00	"	"	"	"	"	"	75-10
2124	133, 136	.60	7.00	5/0	"	1st, 2d	"	"	"	60-8
2124	96	.70	8.00	10/0	"	1st	"	"	Polished	60-8
2124	97	.60	7.00	"	"	"	"	"	Gilded	60-8











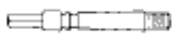
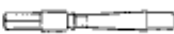
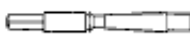

BARS AND SPRINGS

We manufacture a large variety of Bars and Springs and find it impossible to list here all of the kinds made. Below are shown a few of the Pendant Bars, also the several styles of Pendant Springs we make.

PENDANT SPRINGS

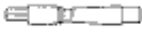
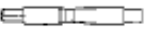
 18s Regular	 18s Dust Proof	 16s Regular	 16s Dust Proof	 18s x 16s	 6s
 0s	 0s x 5/0s	 5/0s	 5/0s x 10/0s	 10/0s	 Bracelet

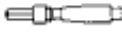
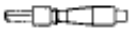
PENDANT BARS

 No. 1685	 No. 1686	 No. 1687	 No. 1688
 No. 1689	 No. 1690	 No. 1691	 No. 1692
 No. 1693	 No. 1694	 No. 1695	 No. 1696
 No. 1697	 No. 1698	 No. 1699	 No. 2371

PRICES

	Piece	Per Doz.
Bars and Springs.....	\$.15	\$1.50
Bars only.....	.10	.75
Springs only.....	.10	.75

PARTS OF PLATES

Prices furnished on application.

When a new plate or parts, such as Barrel Bridges, Train Bridges, Top Plates, Cocks or Pallet Bridges are wanted, the lower plate, the piece to be replaced, together with the material to be used in connection with the new part, should be sent in. This will enable us to fit the new piece to the lower plate, upright and jewel correctly, also to furnish new piece finished with same pattern of damaskeening as on old one.

Always give the movement number in ordering parts of plates. Do not send in a complete watch when a part is wanted. We cannot make partial repairs on a complete watch and guarantee that the watch will perform satisfactorily. If the complete watch is sent it will be handled as a repair job and a charge made for putting the watch in order.

18 SIZE WINDING INDICATOR

This feature is applied to grade 240, 18 size $\frac{3}{4}$ Plate O. F., nickel, 8th model, lever set, 19 jewels.

A cross section of the 18 size Winding Indicator feature is shown on the opposite page.

Part	Letter and Size	Price	
		Piece	Per Dozen
Wheel.....	A 18	.20	2.00
Pinion.....	B 18	.15	1.50
Wheel.....	C 18	.20	2.00
Wheel.....	D 18	.30	3.00
Wheel.....	E 18	.10	1.00
Pinion.....	F 18	.15	1.50
*Wheel.....	G 18	*	*
Wheel.....	H 18	.20	2.00
*Pinion.....	I 18	*	*
Wheel.....	J 18	.15	1.50
Wheel.....	K 18	.15	1.50
Wheel.....	L 18	.15	1.50
Clamp.....	M 18	.20	2.00
Screw.....	282350
Screw.....	283420
Screw.....	160120
Dial (Enamel).....	18 W. I.	1.50	18.00
Dial (Metal).....	18 W. I.	2.50	30.00
Hands, Hour & Min.	2803	.10	.50
" Second.....	2805	.10	.20
" Indicator.....	2894	.10	.25

*Wheel G and pinion I are not supplied separate from wheel D.

Give size in addition to letter when ordering indicator material.

TABLES

Showing the comparative values of the standards of measurements commonly used by watchmakers.

One Douzieme.....	= .0074 inches.
One Millimeter.....	= .03937 inches.
One Ligne.....	= .0888 inches.
One Ligne.....	= 2.256 M. M.

WATCH SIZES

The Lancashire Gauge for determining watch sizes is of English origin and is the standard commonly used by watch manufacturers of the United States. By this system one inch was taken as a basing figure and to this was added $\frac{5}{30}$ of an inch for fall or drop. English made watches were usually hinged, swinging in the case similar to the swing ring in modern swing ring cases. The top plate was made enough smaller than the pillar plate to permit the movement falling or dropping into position without coming in contact with the case center. Thus 1 and $\frac{5}{30}$ of an inch was called naught size and every additional $\frac{1}{30}$ of an inch added to this formed a size. Conversely, each subtraction of $\frac{1}{30}$ of an inch from the base also forms a size smaller than naught size.

Below is given a table showing watch sizes from 15/0 size to 20 size by inches — also their equivalent sizes in millimeters.

Size	Inches	Inches	Millimeters	Size	Inches	Inches	Millimeters
15/0	21/30	.700	17.78	4	1 9/30	1.300	33.02
14/0	22/30	.733	18.62	5	1 10/30	1.333	33.86
13/0	23/30	.766	19.46	6	1 11/30	1.366	34.70
12/0	24/30	.800	20.32	7	1 12/30	1.400	35.56
11/0	25/30	.833	21.16	8	1 13/30	1.433	36.40
10/0	26/30	.866	22.00	9	1 14/30	1.466	37.24
9/0	27/30	.900	22.86	10	1 15/30	1.500	38.10
8/0	28/30	.933	23.70	11	1 16/30	1.533	38.94
7/0	29/30	.966	24.54	12	1 17/30	1.566	39.78
6/0	1	1.000	25.40	13	1 18/30	1.600	40.64
5/0	1 1/30	1.033	26.24	14	1 19/30	1.633	41.48
4/0	1 2/30	1.066	27.08	15	1 20/30	1.666	42.32
3/0	1 3/30	1.100	27.94	16	1 21/30	1.700	43.18
2/0	1 4/30	1.133	28.78	17	1 22/30	1.733	44.02
0	1 5/30	1.166	29.62	18	1 23/30	1.766	44.86
1	1 6/30	1.200	30.48	19	1 24/30	1.800	45.72
2	1 7/30	1.233	31.32	20	1 25/30	1.833	46.56
3	1 8/30	1.266	32.16				

18 SIZE WINDING INDICATOR

Below is shown a cross section of the winding indicator feature as applied to the 18s $\frac{3}{4}$ plate Open Face watches, also illustrations of the front and back of a watch having this feature.

The several pieces are shown in position, also separately, and are lettered in order that they may be readily identified. The small numbers appearing on the various wheels and pinions indicate the number of teeth.

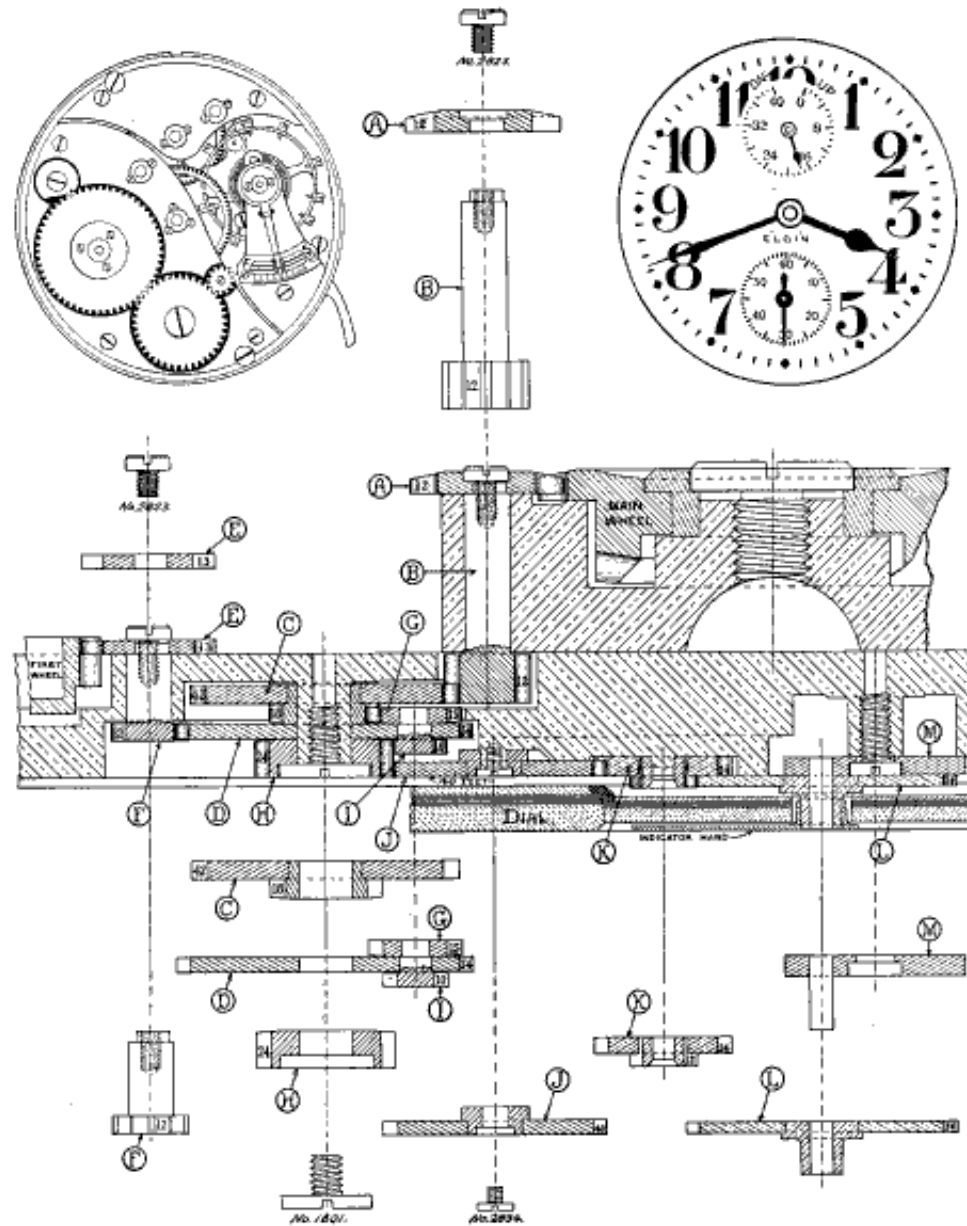

16 SIZE WINDING INDICATOR

The Winding Indicator feature as applied to 16s $\frac{3}{4}$ Plate Open Face watches is shown in cross section on the opposite page. Below is shown the front and back views of a watch having this feature.



The positions of the several pieces is indicated and they are also shown separately with identifying letters in order that they may be readily selected. The number of teeth in the various wheels and pinions are marked on them.

This feature is applied to Grades 372, 374 and 391, all of which are 16s $\frac{3}{4}$ Plate, Nickel, 15th model, lever setting watches.

Part	Letter	PRICE	
		Piece	Per Dozen
Wheel.....	A 16	.20	2.00
Wheel.....	C 16	.30	3.00
*Pinion.....	D 16	*	*
*Wheel.....	E 16	*	*
Pinion.....	F 16	.20	2.00
Pinion.....	G 16	.15	1.50
Wheel.....	H 16	.20	2.00
Wheel.....	I 16	.15	1.50
Wheel.....	J 16	.20	2.00
Wheel.....	K 16	.15	1.50
Washer.....	L 16	.10	.50
Clamp.....	M 16	.20	2.00
Screw.....	1996	.20	
Screw.....	2834	.20	
Dial (Enamel).....	16 W I	1.50	18.00
Dial (Metal).....	16 W I	2.50	30.00
Hands, Hour and Minute.....	2604	.10	.50
Hands, Second.....	2606	.10	.20
Hands, Indicator.....	2894	.10	.25

*Wheel E and pinion D are not supplied separate from wheel C.

Give size in addition to letter when ordering indicator material.

TO THE TRADE

We particularly call your attention to notes, tables, special information and several lines of material which have been arranged for the purpose of assisting you in getting just what you require in making satisfactory repairs on Elgin Watches.

TIME SAVERS

	PAGE
Assortments.....	132-135
Balance Staffs, Table of.....	107
Balance Staff Information, Important.....	106
Escape Wheel Diameters, Table of.....	115
Hair Springs, Table of Breguet Strengths.....	100-101
Jewels, Table of Setting Diameters.....	60
Jewels, Roller or Jewel Pin.....	63
Jewels, Pallet Stones.....	64
Jewels, Unset; Train, Balance and Cap.....	62
Pallet Stones, Thickness of.....	64-69-72
Rollers, Table Diameters of.....	82
Taps and Drills, Table of.....	95
Timing Screws, Directions for using.....	94
Watch Sizes.....	128

16 SIZE WINDING INDICATOR

(Cross Section of this Feature as applied to 16 Size, 15th Model Watches)

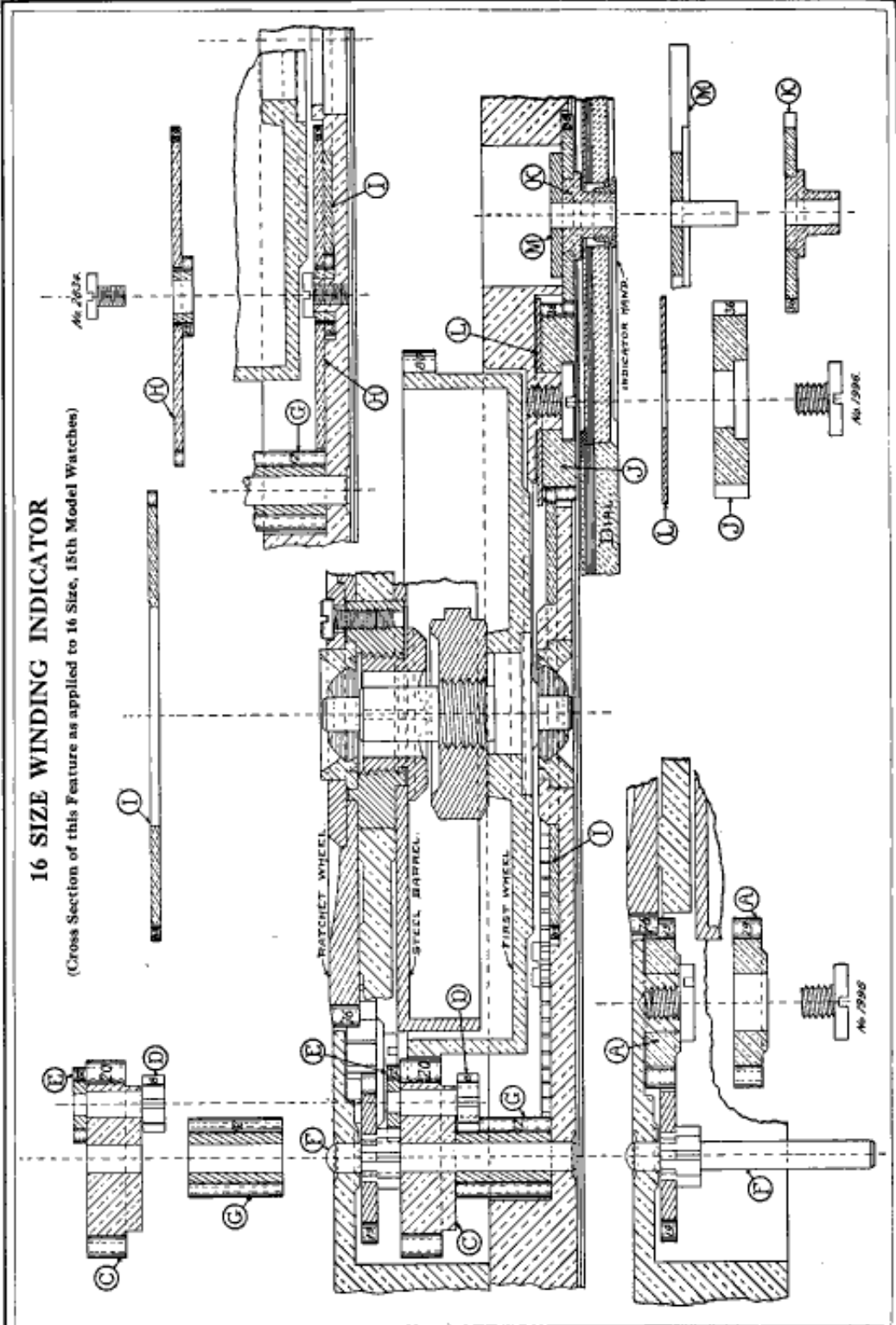

ASSORTED MATERIAL



ASSORTMENTS

Gauged Balance Staffs, Balance Hole Jewels and Roller Jewels

In making up these assortments it has been our aim to supply lines of material which will be most useful to the trade and put it up so conveniently that selections may be quickly made.

The cabinets are of Mahogany, substantially made, and will last a lifetime.

No. 2900 comprises a line of Balance Staffs suitable for 7-jewel grades.

No. 2901 is made up of first quality Ruby Balance Jewels. Every Jewel is carefully examined and the holes are properly proportioned and highly finished.

No. 2902 is arranged particularly for Railroad and other fine grades and Railroad Time Inspectors will find this a most useful assortment.

No. 2903 is made up with polished staffs without oil grooves and is suitable for both 7 and 15 jewel grades.

No. 2904 will be found a very satisfactory assortment of Staffs and Jewels with holes to suit and is made up to meet the requirements of dealers who do not care to invest in the larger assortments.

No. 2905 is made up of 28 diameters of roller Jewels which makes a most complete variety. A Fork slot gauge is supplied with each assortment, and gauging forks and selecting jewels in accordance to directions will prove a saving of time and material. It is the method which has been in use in our factory for many years.

No. 2906 is a very complete and useful assortment of Balance Staffs and Balance Hole jewels.

No. 2907 is a good assortment of Balance Staffs for 7-jewel grades.

ASSORTMENTS PUT UP IN MAHOGANY CABINETS

Catalogue Number	Contents	Quantity	Number of Bottles	Price
2900	Balance Staffs with gauged pivots	12 Doz.	24	18.00
2901	Balance Jewels with gauged holes	6 "	24	18.00
2902	Balance Staffs and Olive hole Bal. Jewels, gauged pivot and holes.	6 "	24	17.50
2903	Balance Staffs polished, gauged pivots.....	6 "	24	10.00
2904	Balance Staffs and Balance hole Jewels, gauged pivots and jewels.	6 "	48	10.00
2905	Roller Jewels, gauged. (With Gauge).....	12 "	28	8.00
2906	Balance Staffs and Balance hole Jewels, gauged.....	9 "	48	13.00
2907	Balance Staffs, gauged pivots	6 "	24	7.00



Illustration is
Three-Fourths
Actual Size



Illustration is
Two-Thirds
Actual Size

NUMBER AND GRADE
 WITH
CLASSIFICATION AND DESCRIPTION OF MOVEMENTS
 MANUFACTURED TO DATE

Number.		Grade.	Class.	Size.		Number.		Grade.	Class.	Size.	
101 to	1,000.	Ray.	1	18	F. Pl.	34,001 to	35,000.	Tay.	3	18	F. Pl.
1,001	1,800.	Culver	2	"	"	35,001	36,000.	Ray.	1	"	"
1,801	2,200.	Ray.	1	"	"	36,001	38,000.	Tay.	3	"	"
2,201	4,000.	Culver	2	"	"	38,001	39,000.	Ray.	1	"	"
4,001	5,000.	Ray.	1	"	"	39,001	40,000.	Tay.	3	"	"
5,001	6,000.	Ryer.	4	"	"	40,001	41,000.	L. E.	47	10	1/2 Pl.
6,001	7,000.	Wh.	4	"	"	41,001	42,000.	Tay.	3	18	F. Pl.
7,001	8,000.	Ryer.	4	"	"	42,001	43,000.	Ray.	1	"	"
8,001	9,000.	Wh.	4	"	"	43,001	44,000.	Culver	2	"	"
9,001	10,000.	Lafin	4	"	"	44,001	46,000.	Wh.	4	"	"
10,001	11,000.	Wh.	4	"	"	46,001	47,000.	Ray.	1	"	"
11,001	12,000.	Lafin	4	"	"	47,001	48,000.	Culver	2	"	"
12,001	13,200.	Ryer.	4	"	"	48,001	50,000.	Wh.	4	"	"
13,201	14,000.	Lafin	4	"	"	50,001	51,000.	F. R.	46	10	1/2 Pl.
14,001	15,000.	Wh.	4	"	"	51,001	53,000.	Ferry	4	18	F. Pl.
15,001	16,000.	Ryer.	4	"	"	53,001	54,000.	Ryer.	4	"	"
16,001	18,000.	Wh.	4	"	"	54,001	55,000.	Wh.	4	"	"
18,001	19,000.	Ryer.	4	"	"	55,001	56,000.	Ferry	4	"	"
19,001	20,000.	Ray.	1	"	"	56,001	57,000.	Culver	2	"	"
20,001	21,000.	Lafin	4	"	"	57,001	60,000.	Ryer.	4	"	"
21,001	22,000.	Wh.	4	"	"	60,001	63,000.	L. E.	47	10	1/2 Pl.
22,001	23,000.	Ryer.	4	"	"	63,001	65,000.	Lafin	4	18	F. Pl.
23,001	24,000.	Wh.	4	"	"	65,001	68,000.	Culver	2	"	"
24,001	25,000.	Lafin	4	"	"	68,001	69,000.	Ray.	1	"	"
25,001	25,100.	Tay.	3	"	"	69,001	71,000.	Ferry	4	"	"
25,101	26,000.	Wh.	4	"	"	71,001	73,000.	Wh.	4	"	"
26,001	27,000.	Culver	2	"	"	73,001	75,400.	Wh.	4	"	"
27,001	28,000.	Ryer.	4	"	"	75,401	75,500.	Ferry	4	"	"
28,001	28,000.	Wh.	4	"	"	75,501	75,700.	Tay.	3	"	"
29,001	30,000.	Ryer.	4	"	"	75,701	76,000.	Ogden	5	"	"
30,001	30,010.	Wh.	4	"	"	76,001	80,000.	L. E.	47	10	1/2 Pl.
30,011	30,020.	Ryer.	4	"	"	80,001	85,000.	Lafin	4	18	F. Pl.
30,021	30,030.	Tay.	3	"	"	85,001	90,000.	Ryer.	4	"	"
30,031	30,050.	Wh.	4	"	"	90,001	94,000.	Ferry	4	"	"
30,051	30,055.	Tay.	3	"	"	94,001	95,000.	Wh.	4	"	"
30,055	30,061.	Ferry	4	"	"	95,001	98,500.	Lafin	4	"	"
30,062	30,081.	Wh.	4	"	"	98,501	100,000.	Wh.	4	"	"
30,082		Ferry	4	"	"	100,001	101,000.	Ogden	5	"	"
30,083		Tay.	3	"	"	101,001	102,000.	Far.	5	"	"
30,084	30,085.	Wh.	4	"	"	102,001	105,000.	Fargo	5	"	"
30,085	30,087.	Ferry	4	"	"	105,001	110,000.	Ogden	5	"	"
30,088	30,089.	Ryer.	4	"	"	110,001	111,400.	Far.	5	"	"
30,089	30,099.	Wh.	4	"	"	111,401	115,000.	Ogden	5	"	"
30,100		Ferry	4	"	"	115,001	115,030.	Wh.	4	"	"
30,101	30,115.	Ray.	1	"	"	115,031	115,032.	Ferry	4	"	"
30,116	30,117.	Culver	2	"	"	115,033	115,100.	Wh.	4	"	"
30,118	30,119.	Ray.	1	"	"	115,101	115,118.	Ferry	4	"	"
30,120	30,121.	Culver	2	"	"	115,119	115,120.	Wh.	4	"	"
30,122		Ray.	1	"	"	115,121	115,124.	Ferry	4	"	"
30,123	30,124.	Culver	2	"	"	115,125	115,127.	Ogden	5	"	"
30,125	30,189.	Ray.	1	"	"	115,128	115,129.	Ferry	4	"	"
30,161	30,200.	Culver	2	"	"	115,130	115,133.	Ogden	5	"	"
30,201	30,250.	Tay.	3	"	"	115,134	115,149.	Ferry	4	"	"
30,251	30,253.	Ferry	4	"	"	115,150		Wh.	4	"	"
30,254	30,258.	Wh.	4	"	"	115,151	115,200.	Ferry	4	"	"
30,259	30,295.	Ferry	4	"	"	115,201	115,300.	Wh.	4	"	"
30,296	30,298.	Far.	5	"	"	115,301	115,304.	Lafin	4	"	"
30,299	30,300.	Ferry	4	"	"	115,305	115,306.	Ryer.	4	"	"
30,301	30,386.	Wh.	4	"	"	115,307	115,400.	Lafin	4	"	"
30,387	30,388.	Ogden	5	"	"	115,401	115,403.	Ryer.	4	"	"
30,389	30,400.	Wh.	4	"	"	115,404	115,405.	Lafin	4	"	"
30,401	30,404.	Ryer.	4	"	"	115,406	115,407.	Ryer.	4	"	"
30,405	30,440.	Lafin	4	"	"	115,408	115,413.	Fargo	5	"	"
30,441	30,489.	Ryer.	4	"	"	115,414	115,416.	Far.	5	"	"
30,490	30,494.	Fargo	5	"	"	115,417	115,419.	Ogden	5	"	"
30,495	30,500.	Ryer.	4	"	"	115,420	115,422.	Ryer.	4	"	"
30,501	31,000.	Ray.	1	"	"	115,423	115,428.	Fargo	5	"	"
31,101	32,000.	Tay.	3	"	"	115,429	115,500.	Ryer.	4	"	"
32,001	33,000.	Ryer.	4	"	"	115,501	115,700.	Tay.	3	"	"
33,001	34,000.	Wh.	4	"	"	115,701	115,800.	Ray.	1	"	"

ELGIN NATIONAL WATCH CO.

187

Number.	Grade.	Class.	Size.	Number.	Grade.	Class.	Size.
18,257,001 to 18,259,000	310	113	12	18,399,001 to 18,401,000	413	116	3/0
18,259,001 * 18,260,000	311	114	"	18,401,001 * 18,404,000	320	116	0
18,260,001 * 18,261,000	312	109	16	18,404,001 * 18,407,000	324	117	"
18,261,001 * 18,262,000	336	106	18	18,407,001 * 18,408,000	354	116	"
18,262,001 * 18,263,000	388	98	16	18,408,001 * 18,409,000	286	115	6
18,263,001 * 18,267,000	413	116	3/0	18,409,001 * 18,410,000	288	106	18
18,267,001 * 18,268,000	414	117	"	18,410,001 * 18,412,000	289	115	6
18,268,001 * 18,269,000	280	115	6	18,412,001 * 18,413,000	290	100	16
18,269,001 * 18,271,000	289	115	"	18,413,001 * 18,414,000	291	110	"
18,271,001 * 18,273,000	290	109	16	18,414,001 * 18,415,000	292	109	"
18,273,001 * 18,275,000	291	110	"	18,415,001 * 18,421,000	293	110	"
18,275,001 * 18,276,000	292	109	"	18,421,001 * 18,423,000	298	116	0
18,276,001 * 18,282,000	293	110	"	18,423,001 * 18,424,000	301	113	12
18,282,001 * 18,284,000	298	116	0	18,424,001 * 18,425,000	303	114	"
18,284,001 * 18,285,000	301	113	12	18,425,001 * 18,426,000	311	114	"
18,285,001 * 18,287,000	303	114	"	18,426,001 * 18,427,000	314	113	"
18,287,001 * 18,288,000	314	113	"	18,427,001 * 18,428,000	315	114	"
18,288,001 * 18,289,000	315	114	"	18,428,001 * 18,429,000	344	113	"
18,289,001 * 18,290,000	317	106	18	18,429,001 * 18,430,000	365	109	16
18,290,001 * 18,294,000	320	116	0	18,430,001 * 18,432,000	403	133	5/0
18,294,001 * 18,296,000	324	117	"	18,432,001 * 18,434,000	404	97	10/0
18,296,001 * 18,297,000	336	106	18	18,434,001 * 18,438,000	413	116	3/0
18,297,001 * 18,298,000	354	116	0	18,438,001 * 18,440,000	414	117	"
18,298,001 * 18,299,000	366	110	16	18,440,001 * 18,442,000	415	116	"
18,299,001 * 18,300,000	376	132	"	18,442,001 * 18,443,000	366	110	16
18,300,001 * 18,301,000	403	133	5/0	18,443,001 * 18,445,000	394	114	12
18,301,001 * 18,302,000	404	97	10/0	18,445,001 * 18,446,000	396	114	"
18,302,001 * 18,303,000	286	115	6	18,446,001 * 18,449,000	293	110	16
18,303,001 * 18,304,000	289	115	"	18,449,001 * 18,450,000	413	116	3/0
18,304,001 * 18,305,000	290	109	16	18,450,001 * 18,451,000	313	110	16
18,305,001 * 18,306,000	315	114	12	18,451,001 * 18,452,000	286	115	6
18,306,001 * 18,307,000	354	116	0	18,452,001 * 18,454,000	292	109	16
18,307,001 * 18,308,000	415	116	3/0	18,454,001 * 18,458,000	293	110	"
18,308,001 * 18,310,000	292	109	16	18,458,001 * 18,459,000	294	106	18
18,310,001 * 18,317,000	293	110	"	18,459,001 * 18,460,000	301	113	12
18,317,001 * 18,318,000	295	115	6	18,460,001 * 18,462,000	303	114	"
18,318,001 * 18,320,000	301	113	12	18,462,001 * 18,463,000	311	114	"
18,320,001 * 18,321,000	303	114	"	18,463,001 * 18,464,000	314	113	"
18,321,001 * 18,323,000	311	114	"	18,464,001 * 18,465,000	315	114	"
18,323,001 * 18,325,000	312	109	16	18,465,001 * 18,466,000	317	106	18
18,325,001 * 18,326,000	314	113	12	18,466,001 * 18,467,000	326	106	"
18,326,001 * 18,327,000	317	106	18	18,467,001 * 18,468,000	345	114	12
18,327,001 * 18,328,000	320	116	0	18,468,001 * 18,470,000	413	116	3/0
18,328,001 * 18,331,000	413	118	3/0	18,470,001 * 18,471,000	414	117	"
18,331,001 * 18,332,000	414	117	"	18,471,001 * 18,472,000	286	115	6
18,332,001 * 18,333,000	336	106	18	18,472,001 * 18,473,000	289	115	"
18,333,001 * 18,334,000	344	113	12	18,473,001 * 18,478,000	293	110	16
18,334,001 * 18,335,000	386	109	16	18,478,001 * 18,479,000	314	113	12
18,335,001 * 18,336,000	403	133	5/0	18,479,001 * 18,480,000	315	114	"
18,336,001 * 18,337,000	286	115	6	18,480,001 * 18,481,000	336	106	18
18,337,001 * 18,338,000	288	106	18	18,481,001 * 18,482,000	386	109	16
18,338,001 * 18,339,000	289	115	6	18,482,001 * 18,483,000	387	110	"
18,339,001 * 18,340,000	290	109	16	18,483,001 * 18,485,000	414	117	3/0
18,340,001 * 18,341,000	291	110	"	18,485,001 * 18,486,000	286	115	6
18,341,001 * 18,342,000	292	109	"	18,486,001 * 18,487,000	289	115	"
18,342,001 * 18,349,000	293	110	"	18,487,001 * 18,488,000	292	109	16
18,349,001 * 18,350,000	295	115	6	18,488,001 * 18,489,000	293	110	"
18,350,001 * 18,351,000	298	116	0	18,489,001 * 18,491,000	298	116	0
18,351,001 * 18,352,000	301	113	12	18,491,001 * 18,492,000	301	113	12
18,352,001 * 18,354,000	303	114	"	18,492,001 * 18,494,000	303	114	"
18,354,001 * 18,355,000	311	114	"	18,494,001 * 18,495,000	312	109	16
18,355,001 * 18,356,000	312	109	16	18,495,001 * 18,496,000	377	116	0
18,356,001 * 18,357,000	313	110	"	18,496,001 * 18,497,000	388	98	16
18,357,001 * 18,359,000	314	113	12	18,497,001 * 18,499,000	403	123	5/0
18,359,001 * 18,361,000	315	114	"	18,499,001 * 18,501,000	404	97	10/0
18,361,001 * 18,363,000	320	116	0	18,501,001 * 18,502,000	409	117	0
18,363,001 * 18,365,000	413	116	3/0	18,502,001 * 18,506,000	413	116	3/0
18,365,001 * 18,366,000	324	117	"	18,506,001 * 18,508,000	415	116	"
18,366,001 * 18,368,000	336	106	18	18,508,001 * 18,510,000	293	110	16
18,368,001 * 18,369,000	347	112	12	18,510,001 * 18,511,000	288	106	18
18,369,001 * 18,372,000	354	116	0	18,511,001 * 18,512,000	289	115	6
18,372,001 * 18,373,000	365	109	16	18,512,001 * 18,513,000	290	109	16
18,373,001 * 18,374,000	386	109	"	18,513,001 * 18,515,000	291	110	"
18,374,001 * 18,375,000	387	110	"	18,515,001 * 18,517,000	292	109	"
18,375,001 * 18,377,000	403	133	5/0	18,517,001 * 18,522,000	293	110	"
18,377,001 * 18,378,000	404	97	10/0	18,522,001 * 18,523,000	295	115	6
18,378,001 * 18,379,000	405	96	"	18,523,001 * 18,524,000	298	116	0
18,379,001 * 18,380,000	408	133	5/0	18,524,001 * 18,525,000	303	114	12
18,380,001 * 18,381,000	289	115	6	18,525,001 * 18,526,000	313	110	16
18,381,001 * 18,382,000	290	109	16	18,526,001 * 18,527,000	314	113	12
18,382,001 * 18,384,000	291	110	"	18,527,001 * 18,528,000	315	114	"
18,384,001 * 18,385,000	292	109	"	18,528,001 * 18,529,000	317	106	18
18,385,001 * 18,392,000	293	110	"	18,529,001 * 18,530,000	324	117	0
18,392,001 * 18,393,000	294	106	18	18,530,001 * 18,531,000	344	113	12
18,393,001 * 18,394,000	298	116	0	18,531,001 * 18,532,000	345	114	"
18,394,001 * 18,395,000	303	114	12	18,532,001 * 18,533,000	354	116	0
18,395,001 * 18,396,000	311	114	"	18,533,001 * 18,534,000	408	133	5/0
18,396,001 * 18,398,000	312	109	16	18,534,001 * 18,537,000	413	116	3/0
18,398,001 * 18,399,000	313	110	"	18,537,001 * 18,538,000	416	117	"

INDEX

Number and Grade of Movements, pages 136 to 187

A	Page	A	Page
Arbors, Balance (see Staffs, Balance)	106-107	Center Pinions	76
Arbors, Barrel	19	Center Pinion Nuts	68
Arbors, Center (see Arbors, Setting)	21	Center Pinion Washers	110
Arbors, Pallet	20	Center Staffs	108
Arbors, Pallets and Forks	72-73	Center Staff Bushings	28
Arbors, Setting	21	Center Staff Washers	110
Arbors, Sweep Second	21	Center Wheels	114
Arbors, Winding	21	Center Wheels, Complete	112-113
Arbors, Main Wheel (see Arbors, Barrel)	19	Center Wheel Nuts	68
Arbor Bushings, Barrel	28	Clamps, Minute Wheel	31
Arbor Caps	30	Clamps, Ratchet	31
Arbor Cups	36	Clamps, Ratchet Wheel	32
Arbor Washers	110	Clamps, Setting Wheel	32
Arms, Vibrating	22	Class of Material and Movements used in	18
Assortments	132-135	Clicks	33-34
		Clicks, Assorted	132-133
B		Click Springs	97
Balances	23	Click Springs, Assorted	132-133
Balance Arbors (see Staffs, Balance)	106-107	Click Wheels (see Ratchets)	81
Balance Bridges (see Cocks) (Parts of Plates)	127	Clutches, Setting	34
Balance Cap Jewels, Lower	55	Clutches, Winding and Setting	35
Balance Cap Jewels, Upper	55	Clutch Levers	65
Balance Cap Jewels, Assorted	132-133	Clutch Lever Springs	98
Balance Hole Jewels, Lower	54	Cocks (Parts of Plates)	127
Balance Hole Jewels, Upper	54	Collets, Barrel Arbor	36
Balance Hole Jewels, Assorted	132-135	Collets, Hair Spring	35
Balance Springs (see Springs, Hair)	99-101	Combination Rollers	83
Balance Spring Collets (see Collets Hair Spring)	35	Combination Rollers with Jewels	83
Balance Staffs	106-107	Crown Taps	95
Balance Staffs, Assorted	132-135	Crown Wheels (see Wheels, Main)	122
Balance Studs (see Studs, Hair Spring)	109	Cups, Arbor	36
Balance Wheels (see Balances)	23	Cups, Center	36
Bands, Dust (Dust Rings)	24-25	Cups, Setting Arbor (see Cups, Center)	36
Barrels	26-27	Cups, Winding (see Cups, Arbor)	36
Barrels, Hubs and Screws, Fitted	28		
Barrel Arbors	19	D	
Barrel Arbor Bushings	28	Description of Movements	5-10
Barrel Arbor Collets	36	Detents (see Clicks)	33-34
Barrel Arbor Hubs	46	Detent Springs (see Springs, Click)	97
Barrel Arbor Jewels, Lower	56	Dials (Illustrations)	38-42
Barrel Arbor Jewels, Upper	56	Dials (Prices of)	37
Barrel Bridges (Parts of Plates)	127	Dial Feet (Location of)	43-45
Barrel Hubs	46	Dial Wheels and Pinions (see Wheels, Minute)	120
Bars, Pendant	127	Dial Wheels with Socketts (see Wheels, Hour)	119
Bars, Setting	25	Dust Bands (Dust Rings)	24-25
Bevel Pinions	74	Dust Rings (see Dust Bands)	24-25
Bevel Pinion Bridges (Parts of Plates)	127		
Bevel Pinion Pins	80	E	
Bevel Pinion Pivots	80	End Stone Jewels (see Cap Jewels)	55-58-61-62
Bevel Wheels (see Main Wheels)	121-122	Escape Cap Jewels, Lower	58
Bridges, Balance (see Cocks) (Parts of Plates)	127	Escape Cap Jewels, Upper	58
Bridges, Barrel (Parts of Plates)	127	Escape Jewels, Lower	58
Bridges, Bevel Pinion (Parts of Plates)	127	Escape Jewels, Upper	57
Bridges, Pallet (Parts of Plates)	127	Escape Pinions	77
Bridges, Train (Parts of Plates)	127	Escape Wheels	115
Bushings, Barrel Arbor	28	Escape Wheels and Pinions	116
Bushings, Center Staff	28		
		F	
C		Face Wheels with Pinions (see Wheels, Minute)	120
Cams, Setting	20	Face Wheels with Socketts (see Wheels, Hour)	119
Cams, Setting Spring	30	Female Stop Works	105
Cam Levers	65	Fifth Pinions (see Pinions, Escape)	77
Cam Springs	96	Fifth Wheels (see Wheels, Escape)	115
Cannon Pinions	75	Fifth Wheels and Pinions (see Whs. & Pins. Esc.)	116
Cannon Pinions, Assorted	132-133	First Wheels	117
Caps, Arbor	30	Forks	46
Caps, Ratchet, Brass and Nickel (Parts of Plates)	127	Forks and Pallots	70-71
Caps, Ratchet, Steel	30	Forks, Pallets and Arbors	72-73
Cap Jewels, Balance, Lower	55	Fourth Jewels, Lower	60
Cap Jewels, Balance, Upper	55	Fourth Jewels, Upper	59
Cap Jewels, Escape, Lower	58	Fourth Pinions	78
Cap Jewels, Escape, Upper	58	Fourth Wheels	117
Cap Jewels, Pallet, Lower	62	Fourth Wheels and Pinions	118
Cap Jewels, Pallet, Upper	61	Friction Rings	81
Center Arbors (see Arbors, Setting)	21		
Center Cups	36	G	
Center Jewels, Lower	57	Going Wheels (see Barrels)	26-27
Center Jewels, Upper	56	Grades of Movements	5-10

H		P	
	Page		Page
Hair Springs, Collected	90	Pallets	69
Hair Springs, Breguet Strength Table	100-101	Pallets and Forks	70-71
Hair Spring Collets	35	Pallets, Forks and Arbors	72-73
Hair Spring Studs	109	Pallet Arbors	20
Hands, Hour	47-51	Pallet Jewels, Lower	62
Hands, Minute	47-51	Pallet Jewels, Upper	61
Hands, Second	52	Pallet Cap Jewels, Lower	62
Hands, Hour and Minute, Assorted	132-133	Pallet Cap Jewels, Upper	61
Hands, Hour, Minute and Second, Assorted	132-133	Pallet Bridges (Parts of Plates)	127
Hands, Second, Assorted	132-133	Pallet Staffs (see Arbors, Pallet)	20
Hand Posts (see Arbors, Setting)	21	Pallet Stones (Jewels)	64
Heads, Pinion (see Pinions, Center)	76	Parts of Plates	127
Hour Hands	47-51	Pendant Bars	127
Hour Wheels	119	Pendant Springs	127
Hubs, Barrel	46	Pendant Taps	95
Hubs, Barrel Arbor	46	Pinions, Bevel	74
I		Pinions, Cannon	75
Indexes	53	Pinions, Cannon, Assorted	132-133
Indicator Winding, Material	128-131	Pinions, Center	76
Intermediate Setting Wheels	119	Pinions, Escape	77
Intermediate Winding Wheels	120	Pinions, Escape and Wheels	116
J		Pinions, Fifth (see Pinions, Escape)	77
Jewels, Balance Hole, Lower	54	Pinions, Fourth	78
Jewels, Balance Hole, Upper	54	Pinions, Fourth and Wheels	118
Jewels, Balance Hole, Assorted	132-135	Pinions, Second (see Pinions Fourth)	78
Jewels, Balance Cap, Lower	55	Pinions, Sweep Second	80
Jewels, Balance Cap, Upper	55	Pinions, Third	79
Jewels, Balance Cap, Assorted	132-133	Pinions, Third and Wheels	125
Jewels, Barrel Arbor, Lower	56	Pinions, Winding (see Pinions, Bevel)	74
Jewels, Barrel Arbor, Upper	56	Pinion Heads (see Pinions, Center)	76
Jewels, Center, Lower	57	Pins, Bevel Pinion	80
Jewels, Center, Upper	56	Pins, Jewel	63
Jewels, End Stones (see Cap Jewels)	55-58-61-62	Pins, Setting	80
Jewels, Escape, Lower	58	Pivots, Bevel Pinion	80
Jewels, Escape, Upper	57	Plates, Lower (Parts of Plates)	127
Jewels, Escape Cap, Lower	58	Plates, Top (Parts of Plates)	127
Jewels, Escape Cap, Upper	58	Posts, Hand (see Arbors, Setting)	21
Jewels, Fourth, Lower	60	Posts, Key (see Arbors, Barrel)	19
Jewels, Fourth, Upper	59	Posts, Winding (see Arbors, Barrel)	19
Jewels, Pallet, Lower	62	Potances (Parts of Plates)	127
Jewels, Pallet, Upper	61	Price of Screws	93
Jewels, Pallet Cap, Lower	62	R	
Jewels, Pallet Cap, Upper	61	Ratchets	81
Jewels, Pallet Stones	64	Ratchet Caps, Steel	30
Jewels, Roller or Jewel Pins	63	Ratchet Caps, Brass and Nickel (Parts of Plates)	127
Jewels, Roller or Jewel Pins, Assorted	132-135	Ratchet Clamps	31
Jewels, Sweep Second, Upper	56	Ratchet Wheels	122-123
Jewels, Third, Lower	64	Ratchet Wheel Clamps	32
Jewels, Third, Upper	63	Ratchet Wheel Washers	111
Jewel Pins	63	Regulators	84-85
K		Regulator Nuts and Screws	68
Key Posts (see Arbors, Barrel)	19	Regulator Springs	104
L		Rings, Dust (Dust Bands)	24-25
Levers (see Forks)	46	Rings, Friction	81
Levers, Cam	65	Ring Wheels	124
Levers, Clutch	65	Rollers, Combination	83
Levers, Setting	66-67	Rollers, Combination with Jewels	83
Lever Springs, Clutch	98	Rollers, Safety	81
Lever Springs, Setting	98	Rollers, Table	82
Location of Dial Feet	43-45	Rollers, Table with Jewels	82
Lower Plates (Parts of Plates)	127	Roller Jewels or Jewel Pins	63
M		S	
Main Screw Washers	111	Safety Rollers	81
Main Springs	102-103	Scales, Regulating (see Indexes)	53
Main Wheels	121-122	Screws	86-93
Main Wheel Arbors (see Arbors, Barrel)	19	Screws, Assorted	132-133
Main Wheel Studs	105	Screws and Nuts, Regulator	68
Male Stop Works	105	Screws, Price of	93
Mahogany Box Assortments	134-135	Screws, Use and Number	86-92
Metal Box Assortments	132-133	Screw Taps	95
Minute Hands	47-51	Second Hands	52
Minute Wheels	120	Second Hands, Assorted	132-133
Minute Wheel Clamps	31	Second Pinions (see Pinions, Fourth)	78
Models of Movements	11-18	Second Wheels (see Wheels, Center)	114
Movements, Description of	5-10	Second Wheels and Pinions (see Wh. Fourth & Pin)	118
N		Setting Arbors	21
Nuts, Center Pinion	68	Setting Bars	25
Nuts, Center Wheel	68	Setting Cams	29
Nuts and Screws, Regulator	68	Setting Clutches	34
		Setting Arbor Caps (see Center Caps)	36
		Setting Levers	66-67
		Setting Lever Springs	98
		Setting Pins	80
		Setting Shippers	105
		Setting Springs	104

	Page	V	Page
Setting Springs, Assorted	132-133	Vibrating Arms	22
Setting Spring Cams	30	Vibrating Arm Springs	96
Setting Squares (see Arbors, Setting)	21		
Setting Wheels	124	W	
Setting Wheel Clamps	32	Washers, Arbor	110
Setting and Winding Clutches	35	Washers, Center Pinion	110
Shippers, Setting	103	Washers, Center Staff	110
Sleeves, Winding Arbor	96	Washers, Main Screw	111
Springs, Arms, Vibrating	96	Washers, Ratchet Wheel	111
Springs, Balance (see Springs, Hair)	99-101	Wheels, Balance (see Balances)	23
Springs, Cam	96	Wheels, Bevel (see Wheels, Main)	121-122
Springs, Click	97	Wheels, Center	114
Springs, Click, Assorted	132-133	Wheels, Center, Complete	112-113
Springs, Detent (see Springs, Click)	97	Wheels, Click (see Ratchets)	81
Springs, Hair, Collected	99	Wheels, Crown (see Wheels, Main)	121-122
Springs, Hair, Breguet Strength Table	100-101	Wheels, Dial with Pinions (see Wheels, Minute)	120
Springs, Clutch Lever	98	Wheels, Dial with Sockets (see Wheels, Hour)	119
Springs, Setting Lever	98	Wheels, Escape	115
Springs, Main	102-103	Wheels, Escape and Pinion	116
Springs, Pendant	127	Wheels, Face with Pinions (see Wheels, Minute)	120
Springs, Regulator	104	Wheels, Face with Sockets (see Wheels, Hour)	119
Springs, Setting	98	Wheels, Fifth (see Wheels, Escape)	115
Springs, Setting, Assorted	132-133	Wheels, Fifth and Pinion (see Wh., Esc. & Pin.)	116
Springs, Yoke (see Springs, Vibrating Arm)	96	Wheels, First	117
Squares, Setting (see Arbors, Setting)	21	Wheels, Fourth	117
Staffs, Balance	106-107	Wheels, Fourth and Pinion	118
Staffs, Balance, Assorted	132-133	Wheels, Going (see Barrels)	26-27
Staffs, Center	108	Wheels, Hour	119
Staffs, Pallet (see Arbors, Pallet)	20	Wheels, Intermediate Setting	119
Staff, Bushings, Center	28	Wheels, Intermediate Winding	120
Stop Works, Female	105	Wheels, Main	121-122
Stop Works, Male	105	Wheels, Minute	120
Studs, Balance (see Studs, Hair Spring)	109	Wheels, Ratchet	122-123
Studs, Hair Spring	109	Wheels, Ring	124
Studs, Main Wheel	105	Wheels, Second (see Wheels, Center)	114
Studs, Winding Pinion (see Pivots, Bevel Pinion)	80	Wheels, Second and Pinion (see Wh., Fourth & Pin.)	118
Sweep Second Arbors	21	Wheels, Setting	124
Sweep Second Arbor Jewels	56	Wheels, Sweep Second	124
Sweep Second Pinions	80	Wheels, Third	125
Sweep Second Wheels	124	Wheels, Third and Pinion	126
		Wheels, Winding (see Wheels, Ratchet)	122-123
T		Winding Arbors	21
Table of Breguet Hair Spring Strengths	100-101	Winding Arbor Sleeves	96
Table Rollers	82	Winding Bridges (see Bevel Pinion Bridges)	127
Table Rollers with Jewels	82	Winding Cups (see Cups, Arbor)	36
Taps, Crown	95	Winding Pinions (see Pinions, Bevel)	74
Taps, Pendant	95	Winding Pinion Studs (see Pivots, Bevel Pinion)	80
Taps, Screw	95	Winding Posts (see Arbors, Barrel)	19
Third Jewels, Lower	64	Winding Wheels (see Wheels, Ratchet)	122-123
Third Jewels, Upper	63	Winding and Setting Clutches	35
Third Pinions	79	Winding Indicator Material	128-131
Third Wheels	125		
Third Wheels and Pinions	126	Y	
Top Plates (Parts of Plates)	127	Yokes (see Arms, Vibrating)	22
Train Bridges (Parts of Plates)	127	Yoke Springs (see Vibrating Arm Springs)	96