

LONGINES

CALIBRE 431



Calibre de base
Basic calibrer
Calibre de base
Grundkaliber
Calibro di base

430

11½''' – Ancre – 17 rubis
Seconde au centre-automatique
Quantième à guichet
Ah 36000

11½''' – Pallet-fork – 17 jewels
Sweep second-automatic
Date showing through aperture in dial
W.p.h. (vibrations per hour) 36000

11½''' – Ancora – 17 rubies
Segundero central-automático
Calendario con ventanilla
Ah (alternaciones horarias) 36000





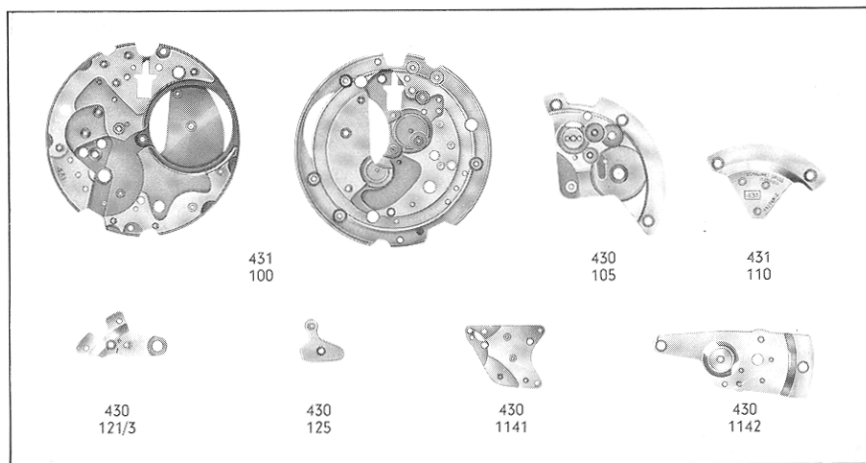
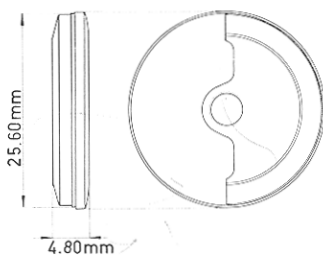

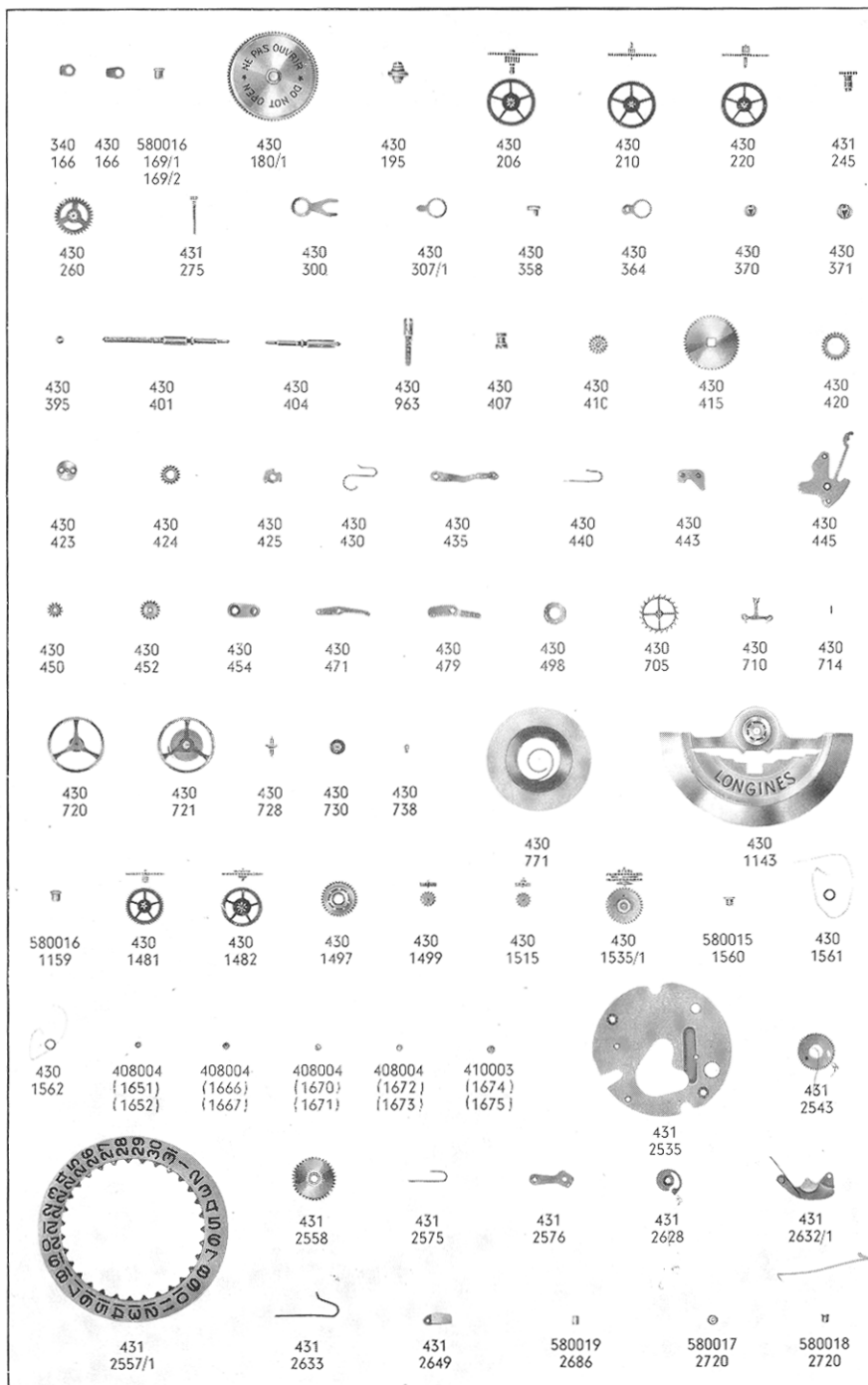













11½''' – Anker – 17 Rubine
Zentrumsekunde-automatisch
Datum mit Fenster
Ah (Halbschwingungen pro Stunde) 36000













11½''' – Ancora – 17 rubini
Secondi al centro-automático
Calendario a finestra
Ah (Alternanze orarie) 36000





LONGINES

									
107049 (5105) (5110)	107052 (5121/3)	107051 (5125)	109040 (5166)	108023 (5415)	105034 (5423)	106043 (5425)	107053 (5445)	106043 (5454)	105005 (5471)
									
107053 (5479)	104010 (5738)	107054 (5750)	106041 (51141)	107049 (51142)	107050 (51142)	108024 (51143)	105046 (52535)	105046 (52543)	

					
416000 (664)	426000 (665)	208031 (601)	209030 (602)	201604 (605)	201604 (606)
					
201604 (610)	201604 (611)	201105 (615)	201105 (616)	201104 (620)	201104 (621)