	Technical Guide		TG-19-C-045-E	C
	Made by: pelrom	Date: 12.09.2008	3	Modifications: see last page

CALIBRE 3301

	Version A	Version B
<p>12^{'''} Ø 27 mm</p>		
Height on movement	6.85 mm	
Power reserve	52 h	
Number of jewels	33	
Frequency	4 Hz (28'800 A/h)	

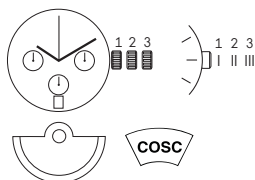

Automatic movement, exclusive Omega chronograph, date, COSC certified, Swiss Pallet fork escapement. Chronograph system with column-wheel. 30-min. minute counter and 12-h hour counter + small second hand at 9 o'clock. Omega balance system without index.

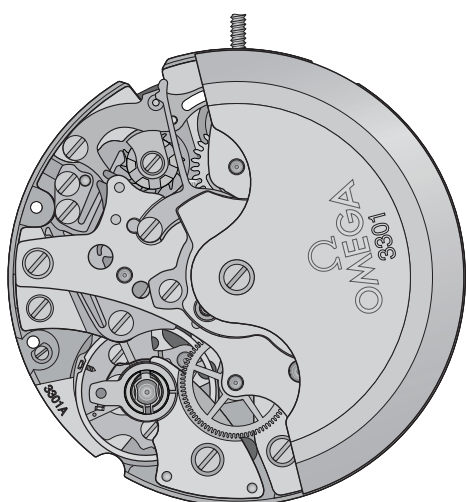

	Page
Calibre 3301	1
General information for Calibre 3301	3-7
Exchange / Key points / Lubricants / Mandatory tools	3
Tightening and untightening torques according to screw thread size	3
Technical modifications on version «A» and «B»	4-5
Lubrication of crow wheel and the three driving wheels for ratchet wheel	6-7
Differences between the versions for Calibre 3301	8
Differences between the versions	8
Exploded views for Calibre 3301	9-13
Dial side	9
Movement side	10
Movement side	11
Movement side	12
Dial side	13
Spare parts list & illustrations for Calibre 3301	14-18
Spare parts & illustrations	14
Spare parts & illustrations	15
Spare parts & illustrations	16
Spare parts & illustrations	17
Spare parts & illustrations	18
Specific information for Calibre 3301	19-23
Chronograph wheel function / Description of chronograph system	19
Chronograph setting	20
Runners for hand setting and hand setting force / Epilame coating	21
Instantaneous rate	22
Modifications of Technical Guide versions for Calibre 3301	23

General information for Calibre 3301

Balance bridge and chronograph bridge

The bridges with serial numbers are not available (see CS-Info Calibre No 33). For exchange, see table:

Exchanges		With serial no
Version A	Chronograph bridge (ref. 722330115040N)	For exchanges always sent to Omega. Engravings at Omega within 4 weeks.

Exchanges		With serial no
Version B	Balance bridge (ref. 7223301B10058)	For exchanges always sent to Omega. Engravings at Omega within 4 weeks.

Key points

The three intermediate driving wheels for ratchet wheel (32.083) must be correctly lubricated with Moebius SYNT-HP-1300 Sans Colorant. Insufficient lubrication could lead to the formation of burrs or chips and hinder the correct winding of the barrel. Cleaning would not be sufficient to remove all this. (see page 6 and 7).

Due to the movement construction, there are various screw lengths. To avoid problems at assembly, group identical screws together for cleaning.

Swiss pallet fork Escapement lubrication

See Working Instruction No 40.

Tightening and untightening torques according to screw thread size

Ø Screw	Tightening torque target cNm	Untightening torque mini cNm
Ø threads ≤ S 0.50 mm	1.0	0.7
Ø threads S 0.6 mm	1.4	0.8
Ø threads S 0.7 mm	1.8	0.9
Ø threads S 0.8 mm	2.2	1.1
Ø threads S 0.9 mm	2.6	1.3
Ø threads S 1.0 mm	3.0	1.6
Ø threads S 1.2 mm	3.5	2.0
Ø threads S 1.4 and >	4.0	2.5

Mandatory tools:

To fit the hands, the movement must be placed in a suitable, well-adjusted movement holder.

Hand fitting

Movement holder for hand fitting
Hand fitting tool kit

Reference
507 0001
507 0011

Movement

Movement holder
Mainspring winder
Timing key

Reference
506 0001
502 150 0009
502 200 0501

Lubricants

Moebius SYNT-A-LUBE 9010 (2ml)
Moebius SYNT HP-1300 Sans Colorant
Moebius 9504
Moebius 9415
Moebius SYNT HP-500
Kluber P125

Reference
504 200 0001
504 5013
504 5014
504 100 0003
504 5012
504 1000071



General information for Calibre 3301

Date correction

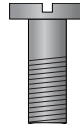

Date correction should not be performed between 10 pm and 2 am.

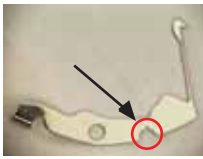
Technical modifications on version «A»

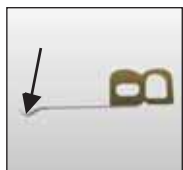

Screw for hammer-lever banking bridge				
Old version	Risk	New version	Improvements	Notes
72233036033	Broken screw head. Old screw length 1.90 mm with guide. Consequence: start/stop function no longer works. The head or the bridge can block the movement.	72233036034	New screw length 1.95 mm without guide, threaded to the end, stronger. New version since week 35/2004.	The new version must be fitted during a maintenance service. If the screw thread cannot be removed from the limitation bridge, the full barrel bridge must be replaced (ref. 722330310041).
				

Column wheel operating lever				
Old version	Risk	New version	Improvements	Notes
722330355040	The column wheel control can bend at the weakest place (see arrow). Consequence: start/stop function does not work.	722330355040	Stronger. New version since week 32/2003.	The new version must be fitted during a maintenance service. The circled part must under no circumstances be bent or modified!
				

Minute counter jumper				
Old version	Risk	New version	Improvements	Notes
722330355143	The jumper breaks at the place where it is bent. Consequence: the minute counter can no longer be reset to zero.	722330355143	Stronger. New version since week 32/2003.	The new version must be fitted during a maintenance service.
				

Hammer operating lever				
Old version	Risk	New version	Improvements	Notes
722330355047	The first execution can bend. The second execution with reset to zero too strong. In both cases, the chronograph hand is not reset correctly to zero.	7223303A55048	The new shape ensures correct resetting to zero and that the hand is held firmly. New version since week 32/2003.	The new version must be fitted during a maintenance service.
				
				

Technical modifications on version «A» and «B»

Rocking bar				
Old version	Risk	New version	Improvements	Notes
722330351052	The setting lever might bend due pressure on stem. Consequence: Malfunction of time setting function.	722330351052	The finger on rocking bar is decreasing this risk. New version available since 27/2008	The new version must automatically be assembled if this case happens.
				

Customer Service lubrication of stud for crown wheel (31.023) and the 3 intermediate driving wheels for ratchet wheel (32.083):

With the aim of constantly improving the performances and reliability of Omega products, the lubrication in Customer Service has been updated.

Amount of lubricant to be applied:

- On the crown wheel stud and the stud for the three ratchets intermediate driving wheels during a service.

Lubrication of stud for crown wheel (Moebius 9504)

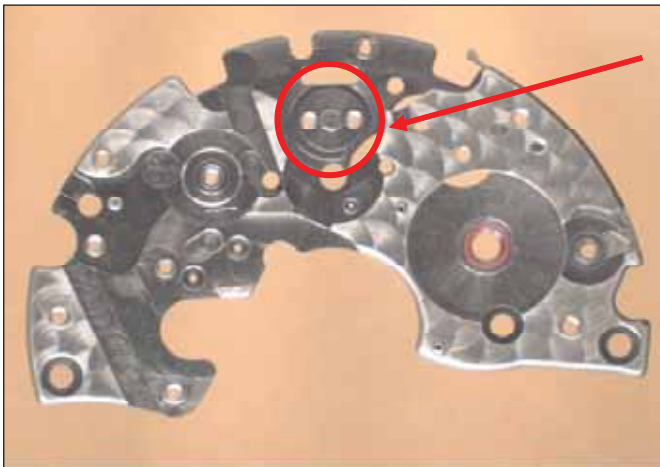

Stud for crown wheel

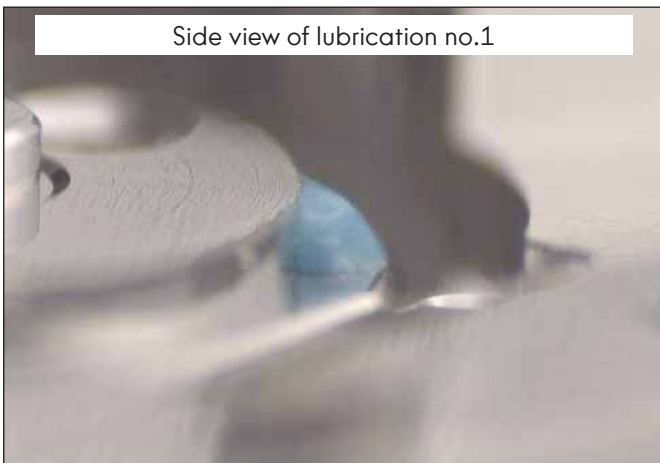
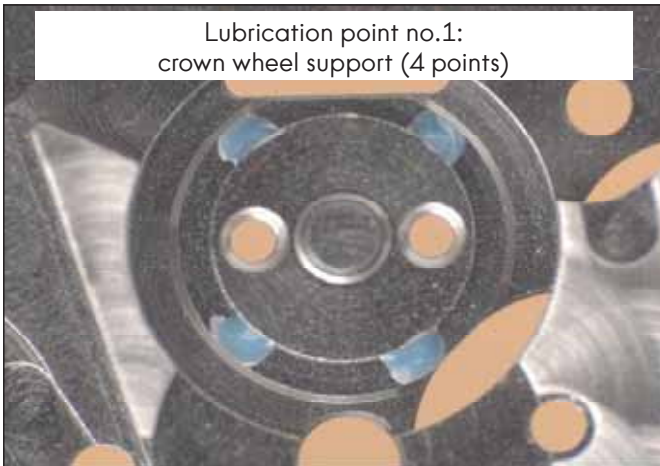

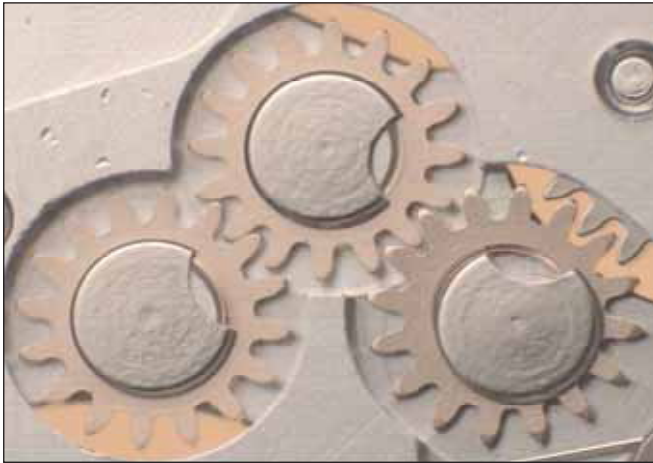

Lubrication of the 3 intermediate driving wheels for ratchet wheel (HP 1300 Sans Colorant)

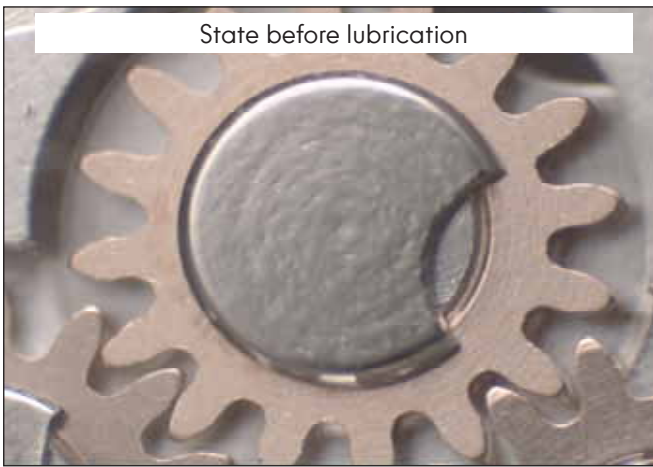

State before lubrication

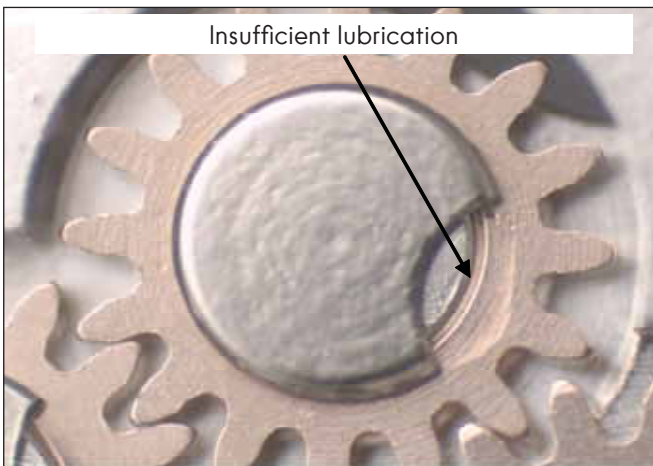



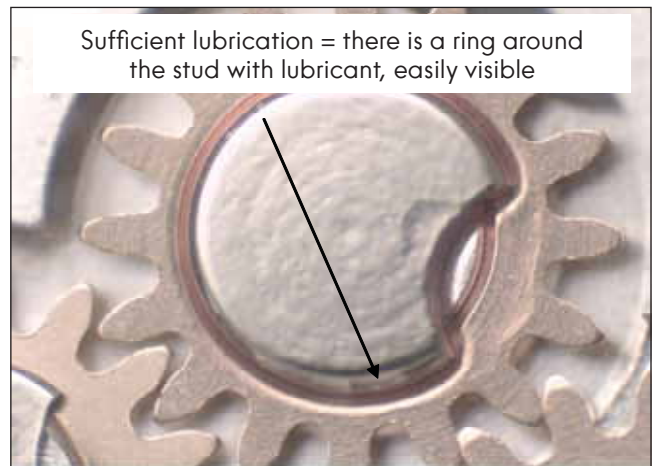





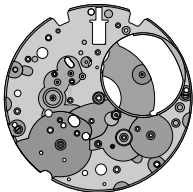
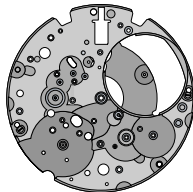
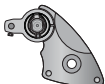
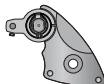

Insufficient lubrication



Sufficient lubrication = there is a ring around the stud with lubricant, easily visible

Differences between Calibre 3301A and 3301B

	3301A (4 Hz)	3301B (4 Hz)
Main plate	 Ref. 722330110020 Ø Hole for dial fastener: 0.80 mm	 Ref. 7223301B10020 Ø Hole for dial fastener: 1.00 mm
Balance bridge, complete	 Ref. 722330110058	 Ref. 7223301B10058
Balance, complete	 Ref. 722330340055 Cylindrical pivots Ø 0.08 mm	 Ref. 7223303B40055 Conical pivots Ø 0.07 mm
Shock-absorber, upper	 Ref. 722330332025 Jewel hole Ø 0.09 mm Nickel-plated	 Ref. 7223313B32027 Jewel hole Ø 0.08 mm Gold-plated
Shock-absorber, lower	 Ref. 722330332062 Jewel hole Ø 0.09 mm Nickel-plated	 Ref. 7223303B70531 Jewel hole Ø 0.08 mm Gold-plated
In setting, upper	 Ref. 7223303A32127 Jewel hole Ø 0.09 mm	 Ref. 7223313B32127 Jewel hole Ø 0.08 mm
In setting, lower	 Ref. 7223303A32167 Jewel hole Ø 0.09 mm	 Ref. 7223313B32167 Jewel hole Ø 0.08 mm



Parts listed in order of assembly

- | | |
|---------------|----------------|
| 1 = 10020 | 7 = 51050 |
| 2 = 31121 | 8 = 61100 |
| 3 = 31120 | 9 = 33082 |
| 4 = 51010 | 10 = 51052 |
| 5 = 51083 | 11 = 51090 |
| 6 = 6407 (1x) | 12 = 7035 (2x) |

 Moebius SYNT HP-1300 Sans Colorant

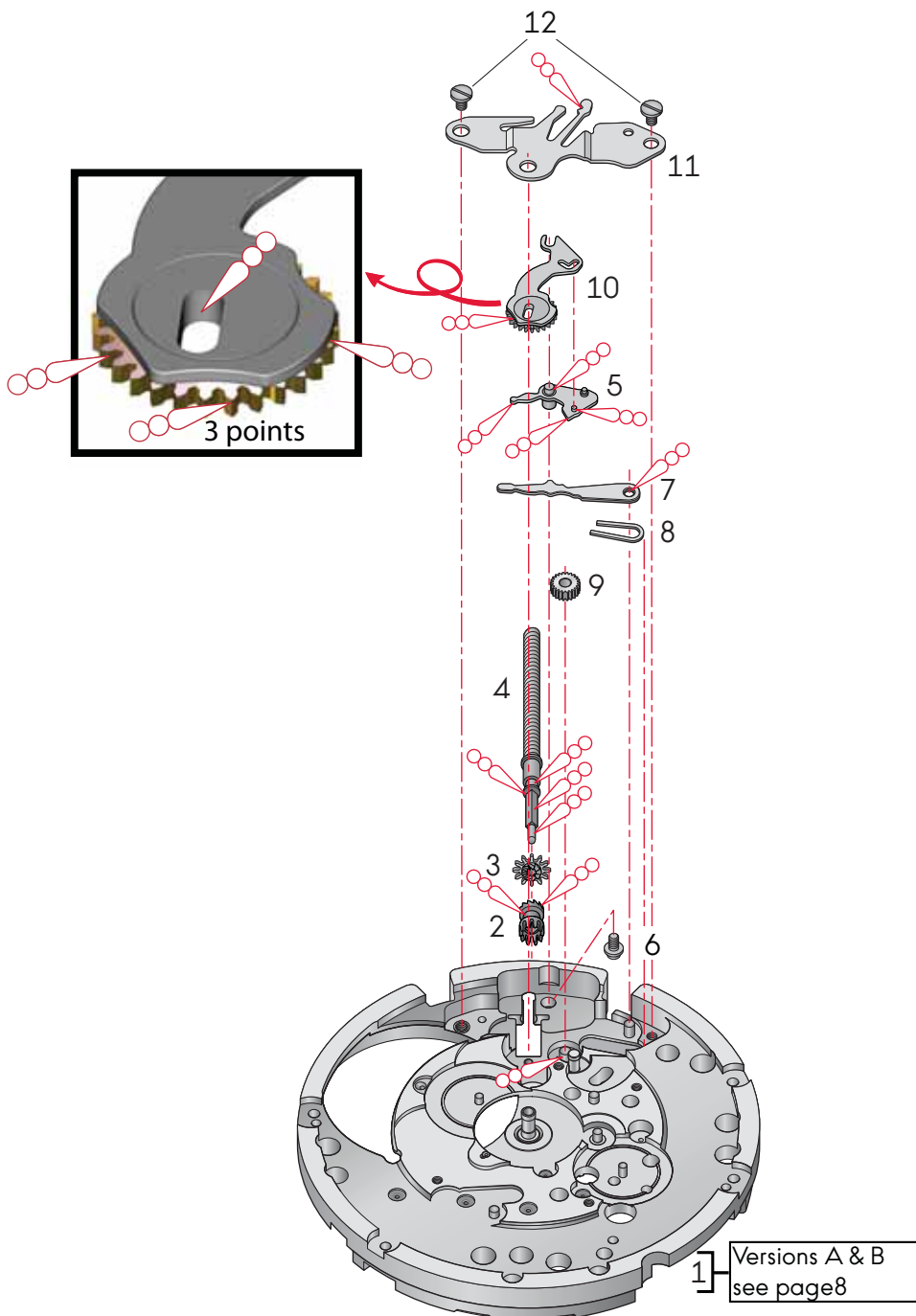

Parts listed in order of assembly

- | | |
|---------------|----------------|
| 1 = 30012 | 9 = 35033 |
| 2 = 30014 | 10 = 56070 |
| 3 = 30025 | 11 = 65040 |
| 4 = 10048 | 12 = 6204 (1x) |
| 5 = 7031 (2x) | 13 = 10041 |
| 6 = 20010 | 14 = 7031 (2x) |
| 7 = 35030 | 15 = 6011 (1x) |
| 8 = 35032 | |

- Moebius SYNT HP-1300 Sans Colorant
- Moebius SYNT-A-LUBE 9010
- Moebius 9504
- Kluber P125

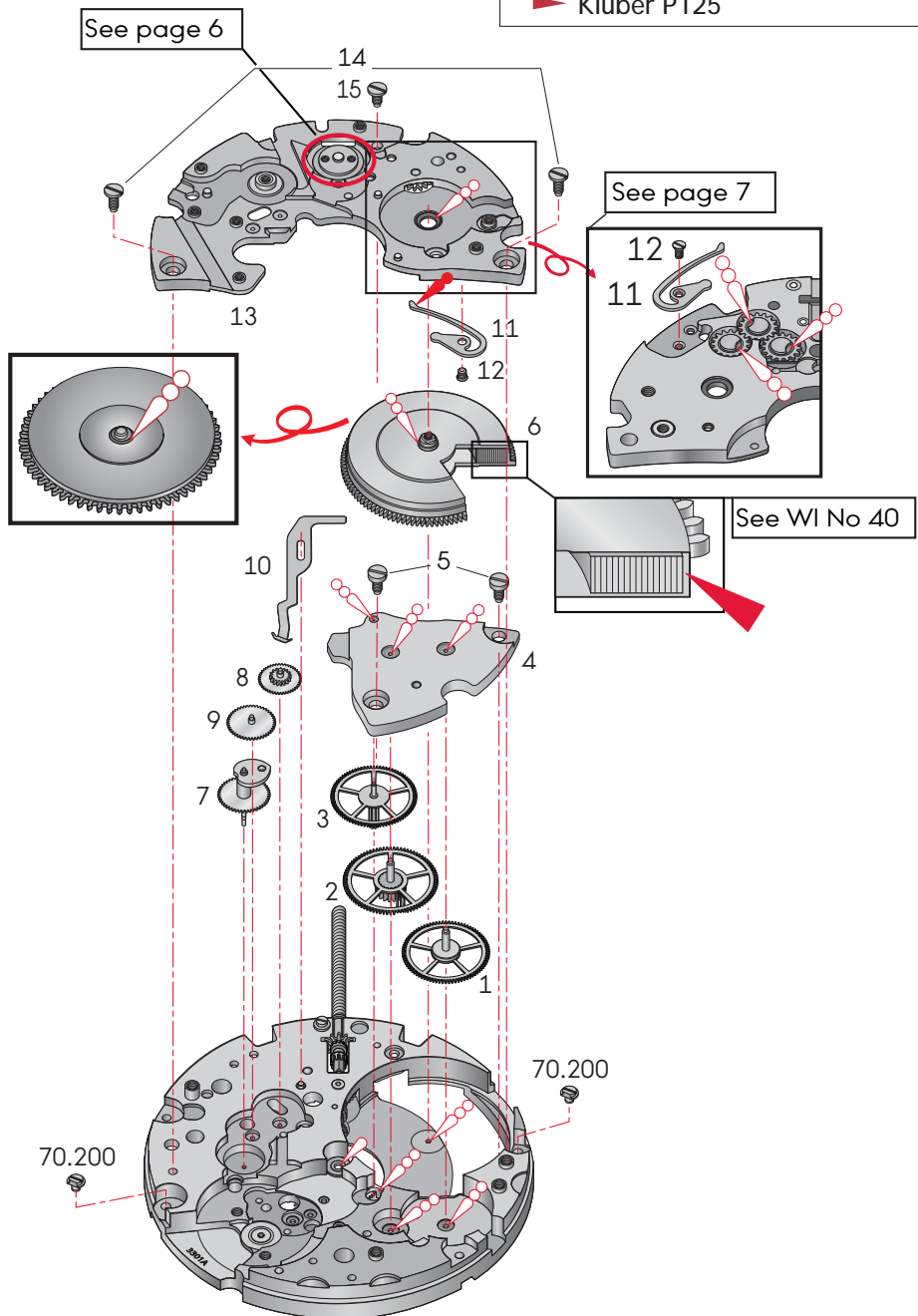

Parts listed in order of assembly

1 = 61080	20 = 55090
2 = 51120	21 = 6004 (1x)
3 = 7008 (1x)	22 = 30027
4 = 31022	23 = 55240
5 = 6019 (1x)	24 = 55048
6 = 31023	25 = 6004 (1x)
7 = 81136	26 = 35031
8 = 6204 (2x)	27 = 35012
9 = 55040	28 = 55248
10 = 6022 (1x)	29 = 15040
11 = 55180	30 = 7031 (3x)
12 = 10615	31 = 7033 (1x)
13 = 6034 (1x)	32 = 65047
14 = 55130	33 = 6012 (2x)
15 = 6004 (2x)	34 = 40010
16 = 30040	35 = 10057
17 = 35010	36 = 8204 (2x)
18 = 55100	37 = 10058/40055
19 = 6004 (1x)	38 = 7031 (1x)

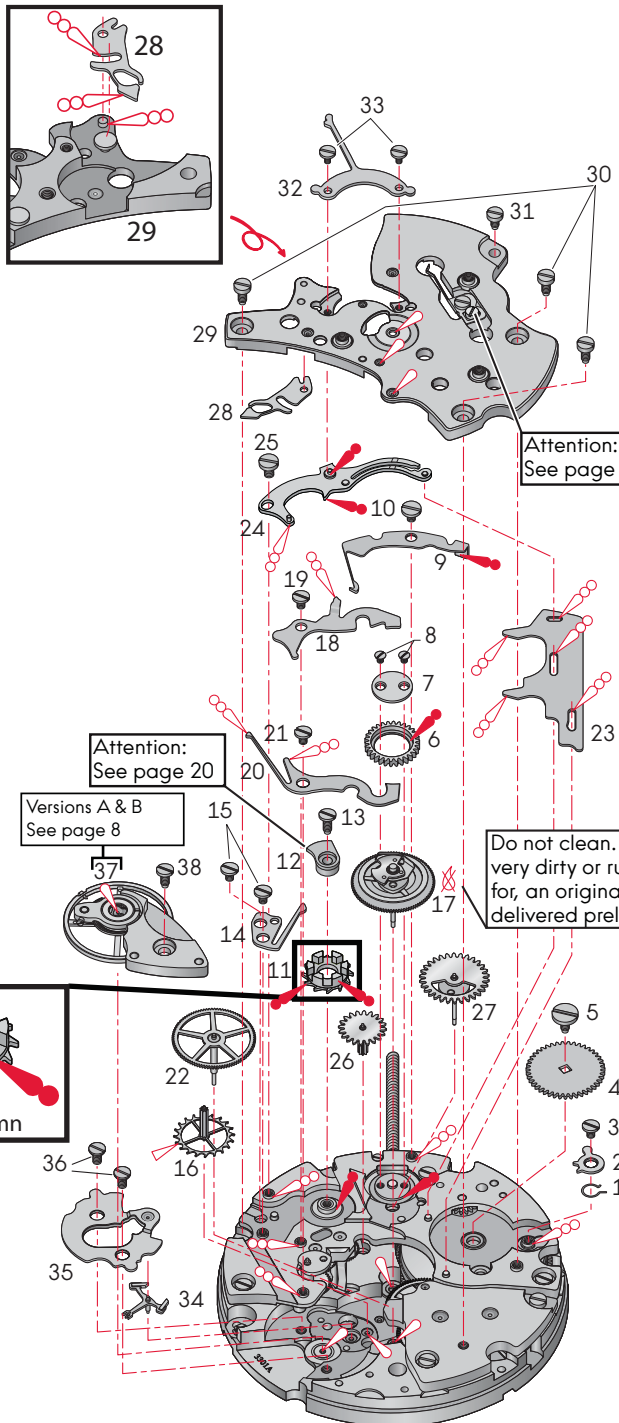

- Moebius SYNT HP-1300 Sans Colorant
- Moebius SYNT-A-LUBE 9010
- Moebius 9504
- Moebius 9415

4 points on teeth
3 points on column

Do not clean. If the part is very dirty or rusted, exchange for, an original part which is delivered prelubricated

Attention: See page 20

Attention: See page 20

Versions A & B See page 8

Parts listed in order of assembly

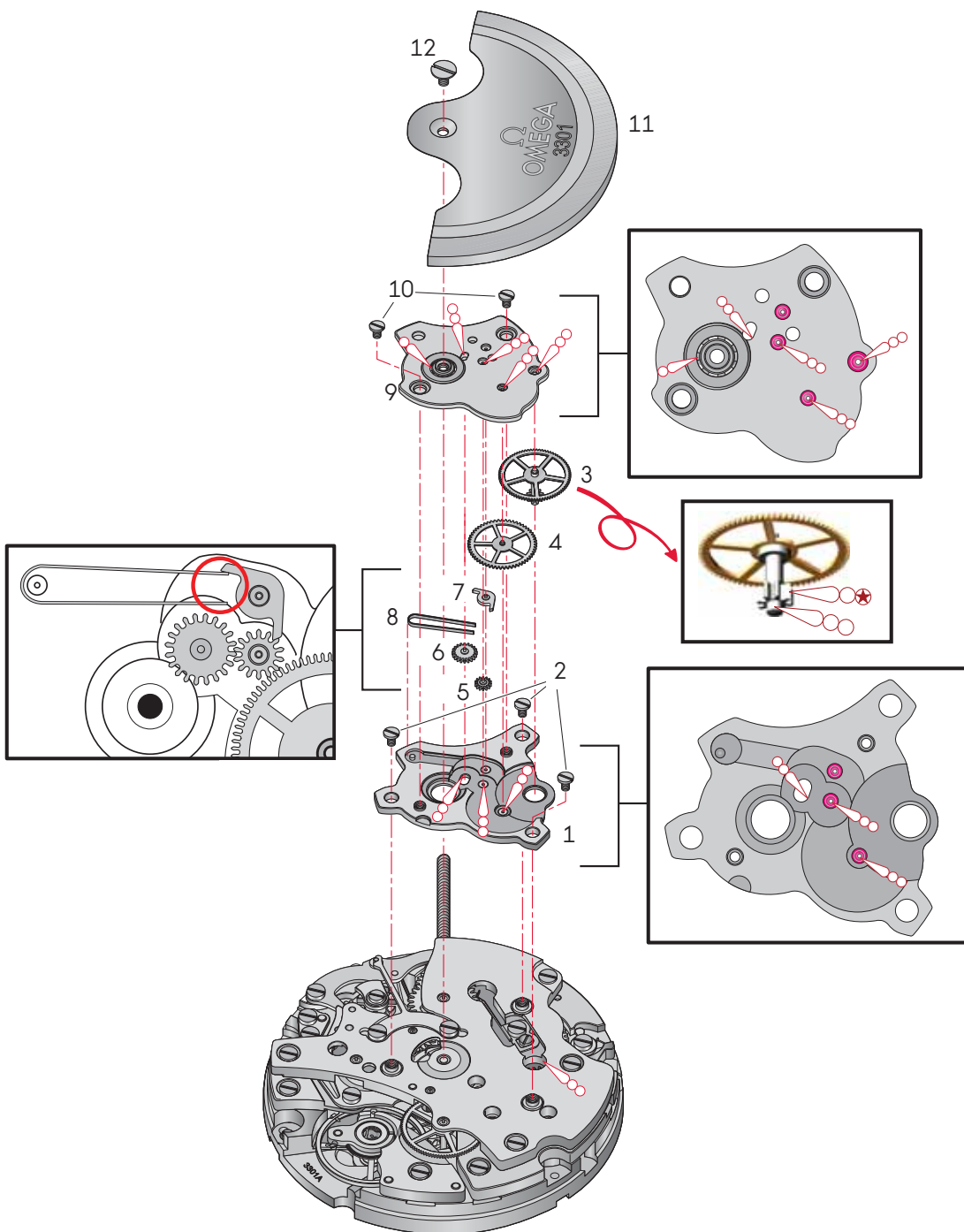

1 = 12030	7 = 52053
2 = 7033 (3x)	8 = 62101
3 = 3203301	9 = 12050
4 = 32031S2	10 = 6003 (2x)
5 = 32105	11 = 22019
6 = 32104	12 = 8200 (1x)

 **Moebius SYNT HP-500**
 **Moebius SYNT HP-1300 Sans Colorant**









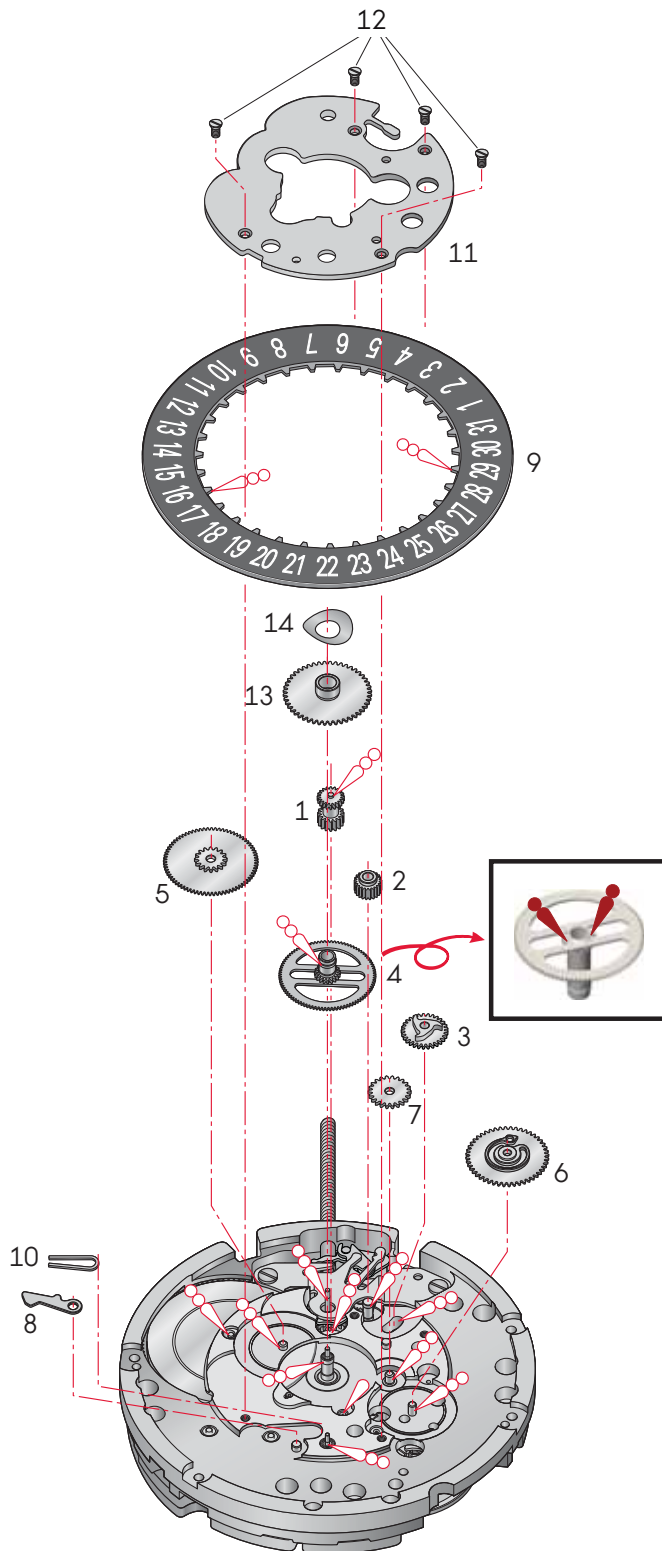



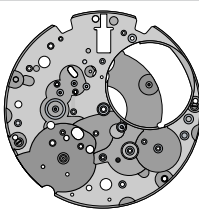
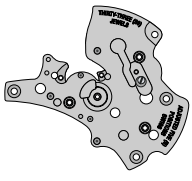

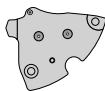

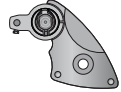

Parts listed in order of assembly

1 = 31102	8 = 53080
2 = 33083	9 = 91440
3 = 53200	10 = 63030
4 = 31080	11 = 13105
5 = 31041S2	12 = 6210 (4x)
6 = 33020	13 = 31046
7 = 33011	14 = 66220

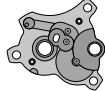













-  Moebius SYNT-A-LUBE 9010
-  Moebius 9504
-  Moebius SYNT HP-1300 Sans Colorant



























Spare Parts list for Calibre 3301

Main Plate pre-assembled	Version	Reference	Chronograph bridge	Version	Reference
	3301A	722330110020		3301A	722330115040N
	3301B	7223301B10020		3301B	722330115040
Barrel bridge jewelled	Version	Reference	Barrel, complete	Version	Reference
	3301A	7223301A10041		3301A	722330320010
	3301B			3301B	
Wheel train bridge, jewelled	Version	Reference	Barrel drum + barrel cover	Version	Reference
	3301A	722330110048		3301A	722330320040
	3301B			3301B	
Pallet bridge	Version	Reference	Barrel arbor	Version	Reference
	3301A	722330310057		3301A	722330320060
	3301B			3301B	
Balance bridge, complete	Version	Reference	Mainspring with bridle	Version	Reference
	3301A	722330110058		3301A	722330320100
	3301B	7223301B10058		3301B	
Hammer operating limitation bridge	Version	Reference	Oscillating wheel	Version	Reference
	3301A	722330310615		3301A	722330122019
	3301B			3301B	
Automatic device framework, jewelled	Version	Reference	Intermediate wheel	Version	Reference
	3301A	722330312030		3301A	722330330012
	3301B			3301B	
Automatic device bridge	Version	Reference	Great wheel	Version	Reference
	3301A	722330112050		3301A	722330330014
	3301B			3301B	
Date indicator maintaining plate	Version	Reference	Third wheel	Version	Reference
	3301A	722330113105		3301A	722330330025
	3301B			3301B	



























Spare Parts list for Calibre 3301

Second wheel	Version	Reference	Shock-absorber, lower	Version	Reference
	3301A	722330330027**		3301A	722330332062
	3301B			3301B	7223303B70531
Escape wheel	Version	Reference	In settings, upper	Version	Reference
	3301A	722330330040		3301A	7223303A32127
	3301B			3301B	7223313B32127
Ratchet wheel	Version	Reference	In settings, lower	Version	Reference
	3301A	722330331022		3301A	7223303A32167
	3301B			3301B	7223313B32167
Crown wheel	Version	Reference	Cap jewel, lower	Version	Reference
	3301A	722330331023		3301A	7223303A32262
	3301B			3301B	
Minute wheel	Version	Reference	Cap jewel, upper	Version	Reference
	3301A	722330331041S2		3301A	7223303A32325
	3301B			3301B	
Hour wheel	Version	Reference	Shock-absorber spring, top	Version	Reference
	3301A	722330331046**		3301A	7223303A32425
	3301B			3301B	
Cannon pinion with driving wheel	Version	Reference	Shock-absorber spring, bottom	Version	Reference
	3301A	722330331080**		3301A	7223303A32462
	3301B			3301B	
Motion work setting wheel	Version	Reference	Ratchet wheel driving wheel	Version	Reference
	3301A	722330331102		3301A	72233033203301
	3301B			3301B	
Winding pinion	Version	Reference	Wig-wag pinion	Version	Reference
	3301A	722330331120		3301A	722330332104
	3301B			3301B	
Sliding pinion	Version	Reference	Stop pinion	Version	Reference
	3301A	722330331121		3301A	722330332105
	3301B			3301B	
Reduction wheel	Version	Reference	Intermediate date wheel	Version	Reference
	3301A	722330332031S2		3301A	722330333011
	3301B			3301B	
Shock-absorber, upper	Version	Reference	Date indicator driving wheel	Version	Reference
	3301A	722330332025		3301A	722330333020
	3301B	7223313B32027		3301B	

Spare Parts list for Calibre 3301

Date corrector intermediate setting wheel 1	Version	Reference	Yoke	Version	Reference
	3301A	7223303A33082		3301A	722330351050
	3301B			3301B	
Date corrector intermediate setting wheel 2	Version	Reference	Rocking bar	Version	Reference
	3301A	722330333083		3301A	722330351052
	3301B			3301B	
Chronograph wheel	Version	Reference	Setting lever	Version	Reference
	3301A	722330335010**		3301A	722330351083
	3301B			3301B	
Minute-counting wheel	Version	Reference	Setting lever jumper	Version	Reference
	3301A	722330335012**		3301A	722330351090
	3301B			3301B	
Hour-counting wheel	Version	Reference	Click	Version	Reference
	3301A	722330335030**		3301A	722330351120
	3301B			3301B	
Driving wheel for counters	Version	Reference	Stop click	Version	Reference
	3301A	722330335031		3301A	722330352053
	3301B			3301B	
Hour counter additional driving wheel 1	Version	Reference	Date jumper	Version	Reference
	3301A	722330335032		3301A	722330353080
	3301B			3301B	
Hour counter additional driving wheel 2	Version	Reference	Date corrector	Version	Reference
	3301A	722330335033		3301A	722330353200
	3301B			3301B	
Pallet fork	Version	Reference	Column wheel operating lever	Version	Reference
	3301A	722330340010		3301A	722330355040
	3301B			3301B	
Balance complete with stud	Version	Reference	Hammer operating lever	Version	Reference
	3301A	722330340055		3301A	7223303A55048
	3301B	7223303B40055		3301B	
Stud support	Version	Reference	Clutch rocker	Version	Reference
	3301A	722330340210		3301A	722330355090
	3301B			3301B	
Winding stem	Version	Reference	Clutch lever	Version	Reference
	3301A	722330351010		3301A	722330355100
	3301B			3301B	

Spare Parts list for Calibre 3301

Column wheel jumper	Version	Reference	Hour wheel friction spring	Version	Reference
	3301A 3301B	722330355130		3301A 3301B	722330366220
Minute counter jumper	Version	Reference	Crown wheel core	Version	Reference
	3301A 3301B	722330355143		3301A 3301B	7223303881136
Chronograph column-wheel	Version	Reference	Dial fastener	Version	Reference
	3301A 3301B	722330355180		3301A 3301B	722330370200
Chronograph and minute hammer	Version	Reference	Date indicator	Version	Reference
	3301A 3301B	722330355240		3301A 3301B	722330391440*
Hour hammer	Version	Reference	Screw for stud	Version	Reference
	3301A 3301B	722330355248		3301A 3301B	72233034002
Eccentric screw	Version	Reference	Screw for automatic device bridge	Version	Reference
	3301A 3301B	722330355445		3301A 3301B	722330360003
Balance stop lever	Version	Reference	Screw for hammer operating lever	Version	Reference
	3301A 3301B	722330356070		3301A 3301B	72226016004
Click spring	Version	Reference	Screw for clutch rocker	Version	Reference
	3301A 3301B	722330361080		3301A 3301B	72226016004
Yoke spring	Version	Reference	Screw for clutch lever	Version	Reference
	3301A 3301B	722330361100		3301A 3301B	72226016004
Stop click spring	Version	Reference	Screw for Column wheel jumper	Version	Reference
	3301A 3301B	722330362101		3301A 3301B	72226016004
Date jumper spring	Version	Reference	Screw for Minute counter jumper	Version	Reference
	3301A 3301B	722330363030		3301A 3301B	72226016004
Column wheel operating lever spring	Version	Reference	Screw for barrel bridge	Version	Reference
	3301A 3301B	722330365040		3301A 3301B	72233036011
Hammer operating lever spring	Version	Reference	Screw for Hammer operating lever spring	Version	Reference
	3301A 3301B	722330365047		3301A 3301B	7223612A6012

Spare Parts list for Calibre 3301

Screw for ratchet wheel	Version	Reference	Screw for setting lever jumper	Version	Reference
	3301A	72233036019		3301A	72233037035
	3301B			3301B	
Screw for column wheel operating lever	Version	Reference	Screw for oscillating weight	Version	Reference
	3301A	72233036022		3301A	72233038200
	3301B			3301B	
Screw for Hammer operating limitation bridge	Version	Reference	Screw for pallet bridge	Version	Reference
	3301A	72233036034		3301A	72233038204
	3301B			3301B	
Screw for column wheel operating lever	Version	Reference			
	3301A	72233036204			
	3301B				
Screw for crown boss	Version	Reference			
	3301A	72233036204			
	3301B				
Screw for date indicator maintaining plate	Version	Reference			
	3301A	72233036210			
	3301B				
Screw for Setting lever jumper	Version	Reference			
	3301A	72233036407			
	3301B				
Screw for click	Version	Reference			
	3301A	72233037008			
	3301B				
Screw for chronograph bridge	Version	Reference			
	3301A	72233037031			
	3301B				
Screw for balance-bridge	Version	Reference			
	3301A	72233037031			
	3301B				
Screw for train wheel bridge	Version	Reference			
	3301A	72233037031			
	3301B				
Screw for barrel bridge	Version	Reference			
	3301A	72233037031			
	3301B				
Screw for chronograph bridge	Version	Reference			
	3301A	72233037033			
	3301B				
Screw for automatic device bridge	Version	Reference			
	3301A	72233037033			
	3301B				

Fig. 1.0a

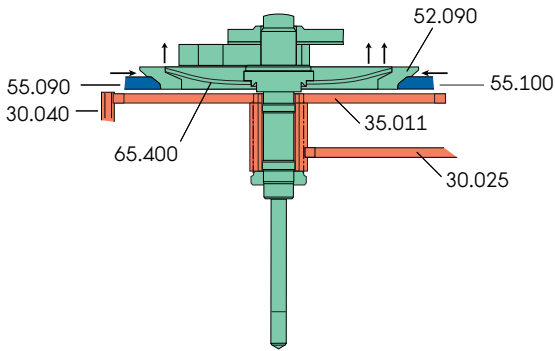
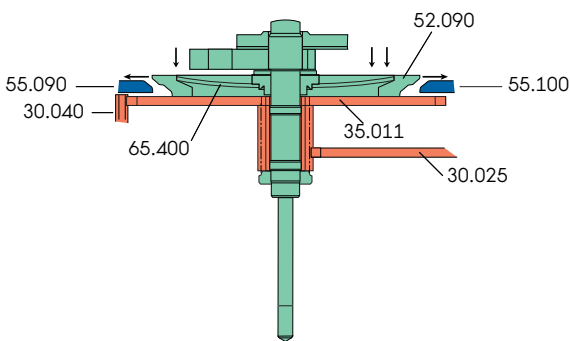

Fig. 1.0b



1.0 Chronograph wheel function

Chronograph wheel 35.010*

Chronograph wheel 35.010* is equipped with a coupling system by which the chronograph can be coupled with and uncoupled from the movement's gear-train.

Do not clean

Chronograph wheel (35.010*):

The chronograph wheel can only be lubricated during the manufacturing process. Cleaning damages the lubrication and could leave cleaning solution residue at the chronograph wheel, which interferes with operating and timing.

Chronograph stoppage position

In chronograph stoppage position, clutch disc 52.090 is raised following clamping by clutch rocker 55.090 and clutch lever 55.100, thus avoiding contact with chronograph pinion 35.011 which is constantly coupled with the movement's gear-train.

Chronograph operating position

In chronograph operating position, clutch disc 52.090 is released simultaneously by clutch rocker 55.090 and clutch lever 55.100. Pushed by chronograph wheel friction spring 65.400, it comes to rest on chronograph pinion 35.011 which will drive it in its travel.

Fig. 1.1

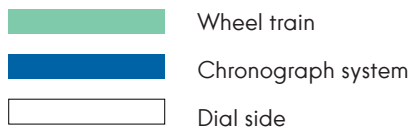

1.1 Description of chronograph system

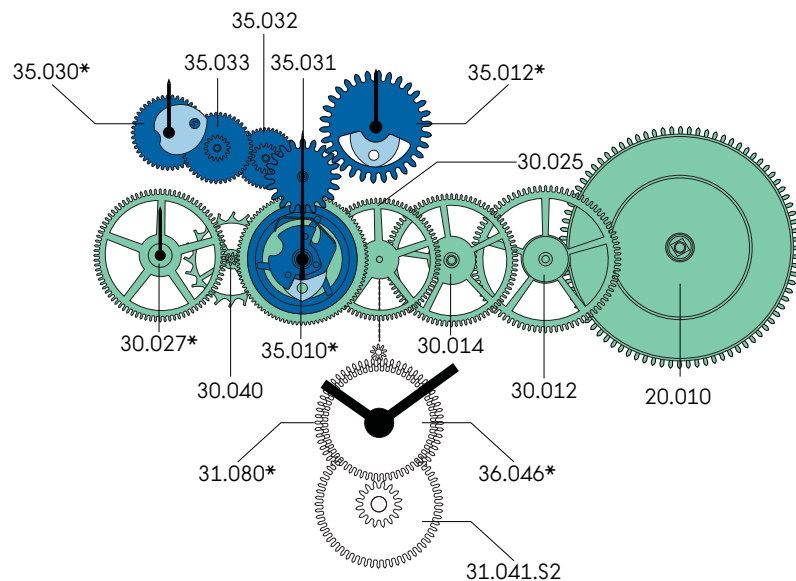

2.0 Chronograph setting

Fig. 2.1

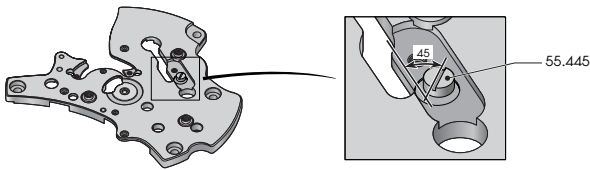

2.1 Check on the eccentric screw for the counter jumper(55.445)

The eccentric screw (55.445) of the counter jumper (55.143) must be positioned as in the drawing. The slot of the eccentric screw (55.445) must form an angle of 45° in relation to the recess in the bridge. An additional correction is subsequently possible when the chronograph is being set. Do not forget to place the hour hammer (55.248) under the bridge and lubricate it.

Fig. 2.2

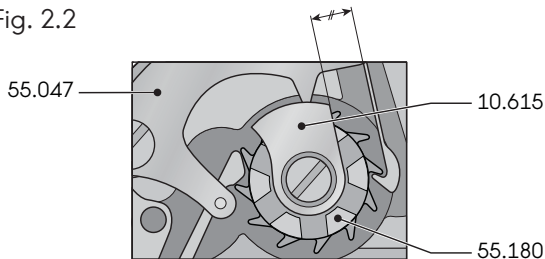

2.2 Hammer-lever banking bridge (10.615)

The hammer-lever banking bridge (10.615) prevents the hammer operating lever (55.047) from moving into an unsuitable position. It should be positioned above the hammer operating lever (55.047) and its straight flank should be parallel to the hammer operating lever spring (65.047).

Fig. 2.3

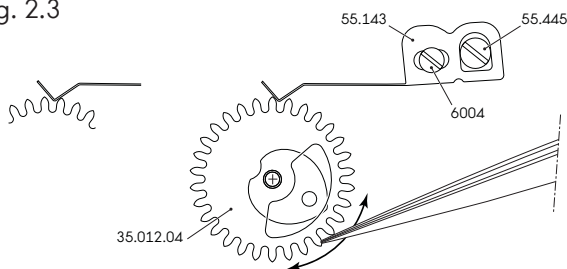

2.3 Check on position of minute counter (35.012*)

Place the chronograph in reset position. Using a plastic or brass point, move the minute counter (35.012*) slightly to the left and right. It is important that the minute counter should return correctly to its original position. With the eccentric screw (55.445), the position of the counter jumper (55.143) can be corrected.

Fig. 2.4 - Drawing 1

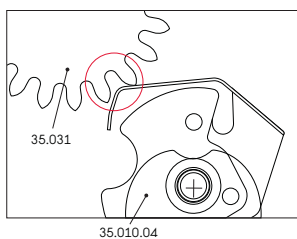
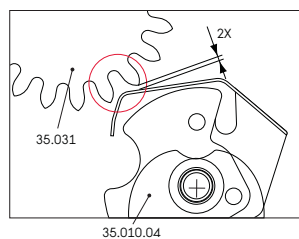

Fig. 2.4 - Drawing 2



2.4 Check on location of chronograph finger in reset position

Check the location of the chronograph finger in reset position. To ensure good synchronisation between the second counter and the minute counter, the chronograph finger should be between the position of «slight contact against the tooth» (see drawing 1) and a maximum distance of twice the thickness of the finger blade (see drawing 2).

Fig. 2.5

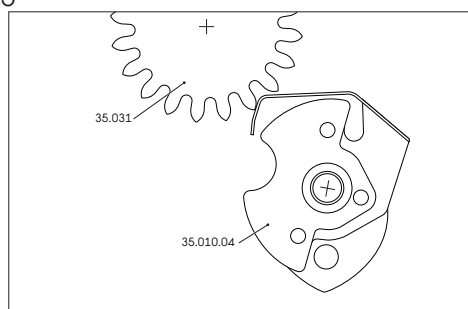

2.5 Chronograph finger operating safety

Put the chronograph in START position. Check that the minute counter jump is operating correctly by checking the penetration of the chronograph finger.

2.6 Checking the minute jump

In the START position, drive the chronograph hand with a brass or plastic point until the minute jumps. The difference in relation to the position of the chronograph's seconds hand in the zero setting position has a tolerance of 2/5 second. Check the function of the counter jumper (55.143) on the hand.

3.0 Runners for hand setting and hand setting force









Description	Movement holder for hand setting	No. of runners for hand setting	Minimum force (N)	Maximum force (N)	Support (jewel)
Hour hand	507 0001	6	10	50	No
Minute hand		2	10	50	No
Chrono second hand in the centre		1	40	60	Yes
Second hand (small)		1	10	40	Yes
Hour counter hand		1	25	50	Yes
Minute counter hand		1	25	50	Yes

4.0 Epilame coating

4.1 Partial epilame coating

Description	Reference	
Pallet fork **	40010	

4.2 Components that should not be epilam-trearede after cleaning

Description	Reference	
Balance fitted on balance bridge	40055 + 10058°	
In setting, upper *	32127	
In setting, lower *	32167	
Pallet bridge	10057	
Barrel****	20010	
Slipping mainspring	20100	
Hour-counting wheel	35030*	
Chronograph wheel ***	35010*	

* Do not treat the shock-absorber settings with epilam; the cap jewels should however be treated.

** Pallet fork: Steep only the two gathering pallets in epilame.

*** Do not clean the chronograph wheel.

**** Do not treat the complete barrel with epilam, only the drum, cover and arbour separately.

For additional information see Working Instructions No 27.

5.0 Instantaneous rate

5.1 Check of the instantaneous rate

Demagnetise the movement before the checks according to Working Instruction 34.

The rate can be checked with a Witschi Watch Expert or a similar apparatus capable of acoustic measurements. The lift angle has to be set to 51 degrees.

The timing of the movement has to be according to the Omega timing specification list.

Please consult Working Instructions 5 and 28 for instructions and tolerances.

Fig. 5.2

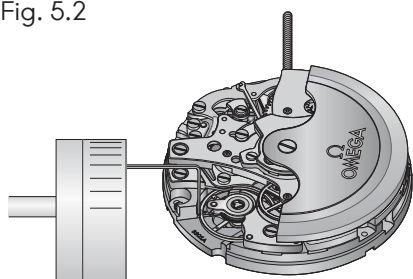
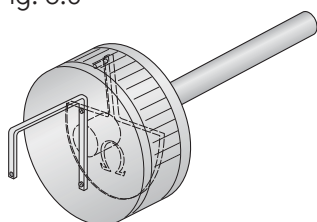
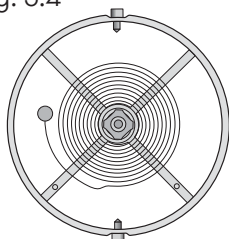

Fig. 5.3



REF. 502 200 0501

Fig. 5.4



5.2 Rate adjustment

A special timing key tool has been developed to adjust the rate even when the movement is cased in (see Fig. 5.3). The rate can be corrected according to the table below by turning the two balance screws a complete turn. A scale is found on the outside of the tool. A division corresponds to a rate correction of 1 second. (according to the table below). One screw is located between two arms on the balance which are specially marked by points (see Fig. 5.4) for easy identification of each screw during the correction process.

Balance

The annular balance has two adjusting micro-screws. A slow rate deviation is corrected by tightening the micro-screws (towards the centre of the balance), which reduces its moment of inertia and makes it run faster. A fast rate deviation is corrected by loosening the micro-screws (away from the centre of the balance). This increases its moment of inertia and makes it run slower.

Important:

The rate is always corrected using **both adjustment screws** to prevent an unbalance of the balance.

Versions A & B identical	
One correction revolution =	57 seconds
One graduation =	1 second



Modifications of Technical Guide versions for Calibre 3301

Technical Guide versions				
First version:	23.03.2006	Version A	Made by:	Pelrom
Second version:	01.04.2006	Version B		Rendav
Last version:	12.09.2008	Version C		

Modifications of Technical Guide version B	
Old version (A)	New version (B)
Tool for checking escapement functions Ref. 506 0002 / Page 4	Tool for checking escapement functions Ref. 506 0004 / Page 4
	Additional drawing of barrel reversed / Page 7
	Additional lubricant point on column wheel on exploded view / Page 8

Modifications of Technical Guide version C	
Old version (B)	New version (C)
	Update of exploded views Update of the lubrication points Diverse Information

