	Technical Guide		TG-19-C-051-E	C
	Made by: pelrom	Date: 04.05.2007	Modifications: See last page	

CALIBRE 8500 - 8501

13^{'''} Ø 29.00 mm	Version A
	
Height on movement 8500	5.50 mm
Height on movement 8501	5.60 mm
Power reserve	60 h
Number of rubies	39
Frequency	3.5 Hz (25'200 A/h)



Manufacture movement, chronometer (COSC-certified), automatic winding, date, centre seconds, time zone, exclusive luxury decoration, arabesque Geneva waves, red engraving, black components, two series-mounted barrels. Barrel one (mainspring with bridle), Barrel two (slipping mainspring) with anti-wear coating. Co-axial escapement wheel with 3-levels, impulse wheel, impulse pinion and drive pinion. Omega free-sprung balance system without index, four white gold regulating screws. Adjusting mechanism for balance end-shake. New patented hairspring-stud fitting system with twisted spring end. New generation of shock-absorbers. Oscillating weight pivoting on plain bearing.



	Page
Calibre 8500 / 8501	1
General information	3
Instantaneous rate/Screwing torques according to screw thread	
Lubricants/Cleaning and epilam coating/Operation symbols	
Fitting stages	4-21
Barrel fitting/Barrel bridge lubrication	4
Barrel bridge pre-assembly/Barrel bridge assembly	5
Mechanism 1 assembly	6
Mechanism 2 assembly	7
Pallet fork and coaxial wheel fitting/Pallet fork bridge assembly	8
Wheel train fitting/Wheel train bridge assembly	9
Stop lever function check	10
Wheel train and escapement lubrication	11
Balance installation	12
Shock-absorber lubrication/Limitation bridge assembly	13
Checking and setting height end-shake balance	14
Mechanism 3 assembly	15
Mechanism 4 assembly + date indicator	16
Maintaining plate fitting/Lower automatic bridge assembly	17
Upper automatic bridge assembly	18
Fitting upper automatic bridge to oscillating weight and lubrication	19
Oscillating weight pinion fitting/Oscillating weight bolt fitting	20
Oscillating weight bridge assembly	21
Spare parts list	22-25
Spare parts list	22
Spare parts list	23
Spare parts list	24
Spare parts list	25
Specific information	26-32
Mandatory tools/Dual barrel system	26
Escapement/Balance bridge lubrication	27
Sprung-balance/Fixing hairspring to stud/Information on the movement	28
Automatic system/Calendar	29
Crown functions	30
Components not requiring epilam coating	31
Technical data / Runners for hand setting and hand setting force	32
Balance bridge disassembling/Disassembling the date mechanism maintaining plate	
Components to not be cleaned	33



General information

Complete balance bridge (Ref. 1005818*)

Chronometer balance bridges are not available (see CS-Info. Calibre No. 33).

Hand fitting height

Components marked with an asterisk (*) are available in different versions (height, colour).

Measuring instruments depending on operation types

Operation	Minimum equipment required	Comments
Full or partial maintenance service Co-Axial 3.5 Hz	- Watch Expert II (white case) - Chronoscope M1 (updated version)	
Rate adjustment on new watches: Co-Axial 3.5 Hz	- Watch Expert (red case) - Wicomètre Professionnel - Chronoscope M1 (former version)	Important: the amplitude will not be indicated precisely. This is acceptable for the rate adjustment only!

Instantaneous rate

Demagnetise the movement prior to checks according to Working Instruction No 34.

Screwing torques according to screw thread

Screw Ø	Minimum torque cNm	Maximum torque cNm
Ø threads ≤ S 0.50 mm	0.8	1
Ø threads S 0.6 to S 0.8 mm	1.5	2.5
Ø threads S 0.9 to S 1.0 mm	2.5	3
Ø threads S 1.2 mm	3	3.5
Ø threads S 1.4 and >	3.5	4





Hand fitting

To fit the hands, the movement must be held in a movement holder that supports the seconds wheel jewel.

Winding on Cyclotest equipment

Only Cyclotest 4rpm equipment is permitted.

Lubricants

	Moebius SYNT-A-LUBE 9010 (2ml)	Ref. 504 200 0001
	Moebius SYNT HP-HP-500	504 5012
	Moebius SYNT HP-1300 Sans Colorant	504 5013
	Moebius 9504	504 5014
	Kluber P125	504 100 0007

* An asterisk sign means: small quantity of lubricant required

Cleaning and epilam coating

Consult Working Instruction No. 27 for information on cleaning movement parts and coating them with epilam.

Operation symbols

 Lubrication

 Check

 Important



- ◄ Moebius 9504
- Kluber P125
- ∞ Moebius SYNT HP-1300 Sans Colorant

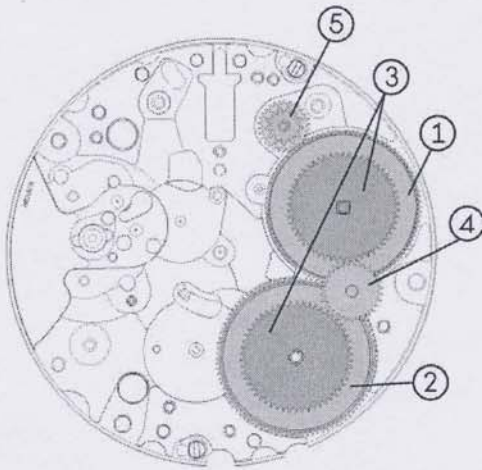

Barrel fitting

- ◄ ▢ Lubricate barrel ①.
- ◄ ▢ Lubricate barrel ②.
- C. Fit the complete barrel one, grey cover (mainspring with bridle) ①.
- D. Fit the complete barrel two, black cover (slipping spring) ②.
- E. Fit the two ratchet wheels ③.
- F. Fit the transmission wheel for ratchet ④.
- ◄ ▢ Lubricate the teeth of transmission wheel for ratchet wheels.
- H. Fit the manual winding reduction wheel ⑤

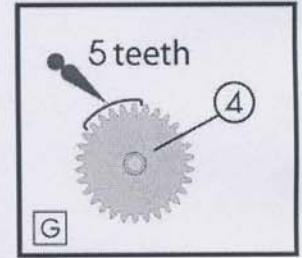
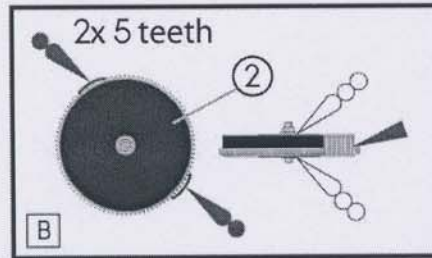
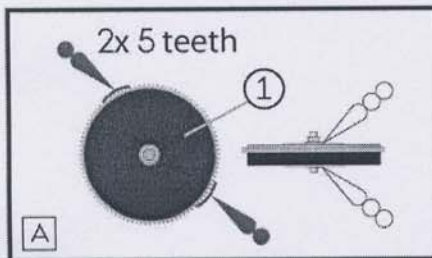

Movement holder	Barrel one, complete	Barrel two, complete	Ratchet wheels	Transmission for ratchet wheels	Reduction wheel for manual winding
	①	②	③	④	⑤
	Ref. 20010	Ref. 20011	Ref. 31020	Ref. 3208319	Ref. 32029
Ref. 506 0058					

Barrel bridge lubrication

- ◄ A. Lubricate the barrel bridge.

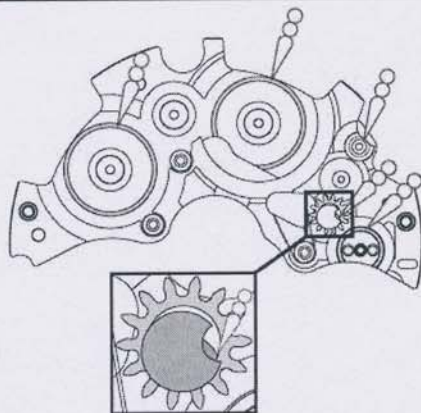

Moebius SYNT HP-1300 Sans Colorant

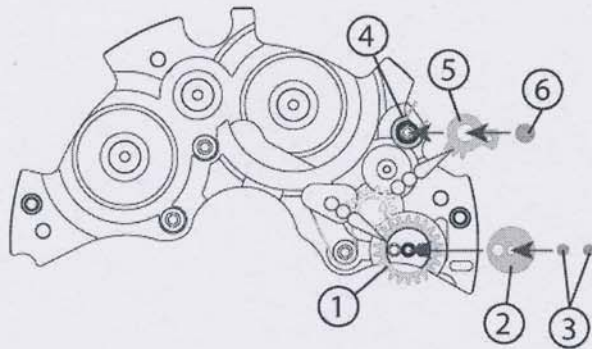

Barrel bridge pre-assembly

- A. Fit the crown wheel ①.
- B. Lubricate the crown wheel.
- C. Fit the crown core ②.
- D. Tighten the two screws ③.
- E. Fit the click spring ④.
- F. Fit the click ⑤.
- G. Fit the screw ⑥.
- H. Lubricate the click teeth ⑤.

Support for barrel bridge assembly	Crown wheel	Crown wheel core	Crown wheel core screw	Click spring	Click	Click screw
Ref. 506 0057	①	②	③	④	⑤	⑥
	Ref. 31023	Ref. 81136	Ref. 3545	Ref. 61080	Ref. 51120	Ref. 3544
	-----	-----		-----	-----	

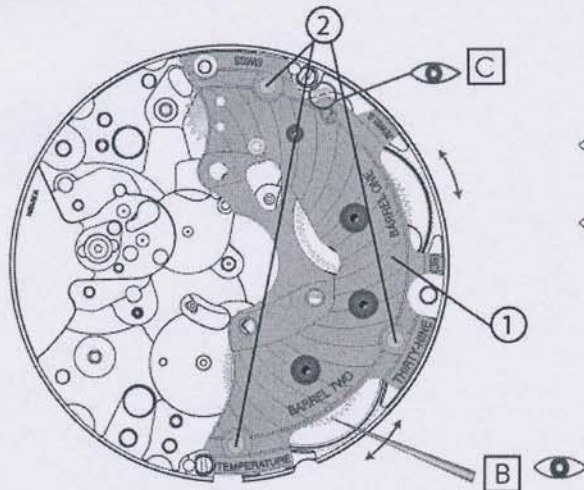



Barrel bridge assembly



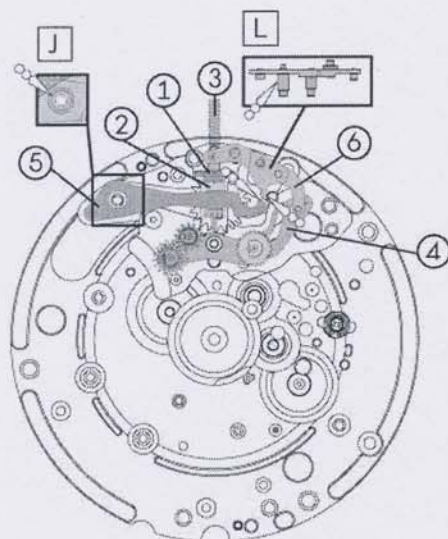





- A. Fit the barrel bridge ①.
- B. Check barrel clearance (plastic stick).
- C. Check click function.
- D. Tighten the three screws ②.

Movement holder	Barrel bridge, pre-assembled	Screw for barrel bridge
Ref. 506 0058	①	②
	Ref. 1004118	Ref. 3534







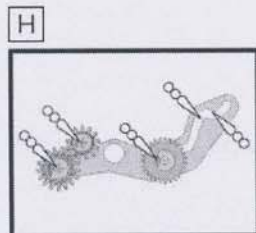
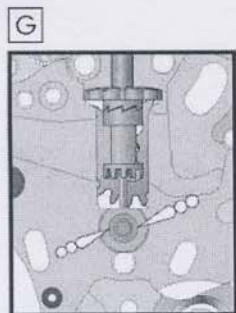
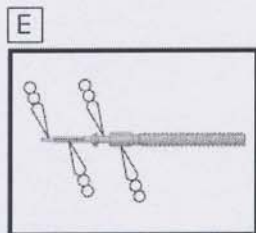
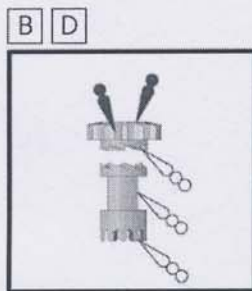

 Moebius 9504
 Moebius SYNT HP-1300 Sans Colorant

Mechanism 1 assembly

- A. Fit the winding pinion ①.
-  B. Lubricate the winding pinion ①.
- C. Fit the sliding pinion ②.
-  D. Lubricate the sliding pinion ②.
-  E. Lubricate the winding stem ③.
- F. Place the winding stem in position ③.
-  G. Lubricate the stud for pre-assembled operating lever for date corrector ④.
-  H. Lubricate the pre-assembled operating lever for date corrector ④.
- I. Fit the pre-assembled operating lever for date corrector ④.
-  J. Lubricate the yoke stud ⑤.
- K. Fit the yoke ⑤.
-  L. Lubricate the guiding pin and stop lever control pin on the pre-assembled setting lever ⑥.
- M. Fit the pre-assembled setting lever ⑥.
-  N. Lubricate the pre-assembled setting lever ⑥ and yoke ⑤.



Movement holder	Winding pinion	Sliding pinion	Winding stem	Operating lever for date corrector, pre-assembled	Yoke	Setting lever, pre-assembled
	①	②	③	④	⑤	⑥
Ref. 506 0058	Ref. 31120	Ref. 31121	Ref. 51010	Ref. 5302218	Ref. 51050	Ref. 5108018
						
	-----	-----	-----	-----	-----	-----

Moebius SYNT HP-1300 Sans Colorant

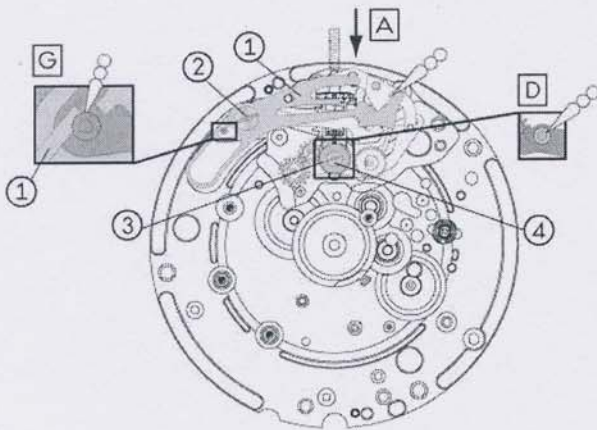

Mechanism 2 assembly

- A Push the stem.
- B Fit the combined setting lever jumper ①.
- C Tighten the screw ②.
- D Lubricate the stud of the intermediate corrector wheel ③.
- E Fit the intermediate corrector wheel ③.
- F Tighten the screw ④.
- G Lubricate the combined setting lever jumper spring and the yoke stud.
- H Lubricate the combined setting lever jumper spring and the pre-assembled setting lever stud.
- I Push and pull the winding stem to check the stem positions 1, 2 and 3.

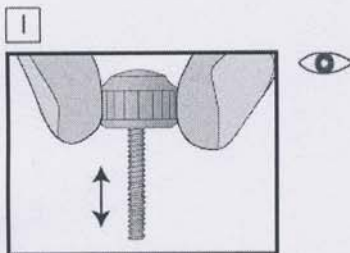

Movement holder	Setting lever jumper	Screw for setting lever jumper	Intermediate corrector wheel	Screw for intermediate corrector wheel
Ref. 506 0058	①	②	③	④
	Ref. 51091	Ref. 3540	Ref. 36051	Ref. 3539

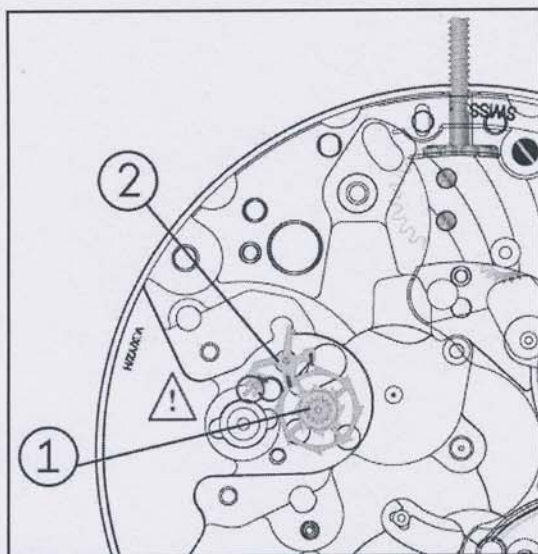

Pallet fork and Co-Axial wheel fitting

- A. Fit and position the co-axial wheel ①.
- B. Fit and position the pallet fork ②.

Never touch the inside of the fork

Movement holder	Co-axial wheel	Pallet fork
Ref. 506 0058	①	②
	Ref. 3004019	Ref. 40010
	-----	-----

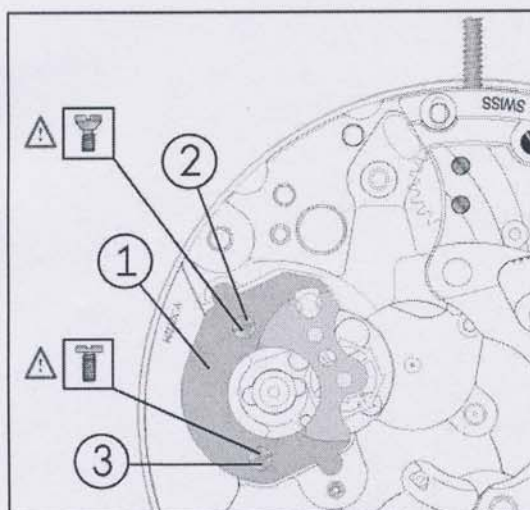

Pallet fork bridge assembly

- A. Fit and position the pre-assembled pallet fork bridge ①.
- B. Tighten the screw (conical head) ② which holds the pallet fork bridge in position.
- C. Tighten the screw (flat head) ③ which maintains the pallet fork bridge in position.

Movement holder	Pallet fork bridge, pre-assembled	Pallet fork bridge screw (conical head)	Pallet fork bridge screw (flat head)
Ref. 506 0058	①	②	③
	Ref. 1005718	Ref. 3538	Ref. 3537

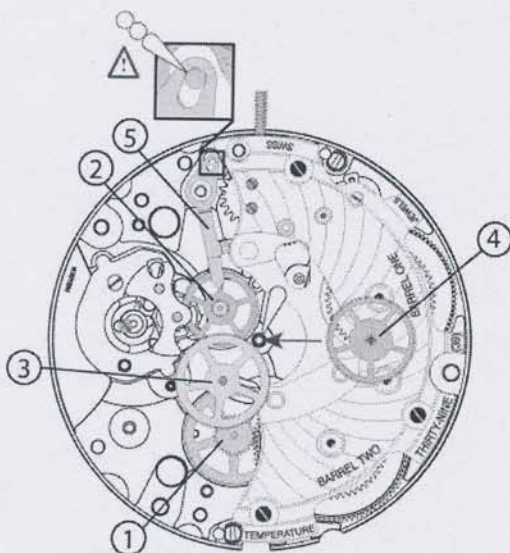

- ▷ Moebius SYNT-A-LUBE 9010
- ∞ Moebius SYNT HP-1300 Sans Colorant

Wheel train fitting

- A. Fit the first wheel ①.
- B. Fit the intermediate escapement wheel ②.
- C. Fit the intermediate train wheel ③.
- ∞ D. Lubricate the seconds wheel jewel.
- E. Fit the seconds wheel ④.
- ⚠ F. Fit the stop lever ⑤.
- ∞ G. Lubricate the stop lever.

Movement holder	First wheel	Intermediate escapement wheel	Intermediate train wheel	Seconds wheel	Stop lever
Ref. 506 0058	①	②	③	④	⑤
	Ref. 30014	Ref. 30039	Ref. 30025	Ref. 3002701	Ref. 56070

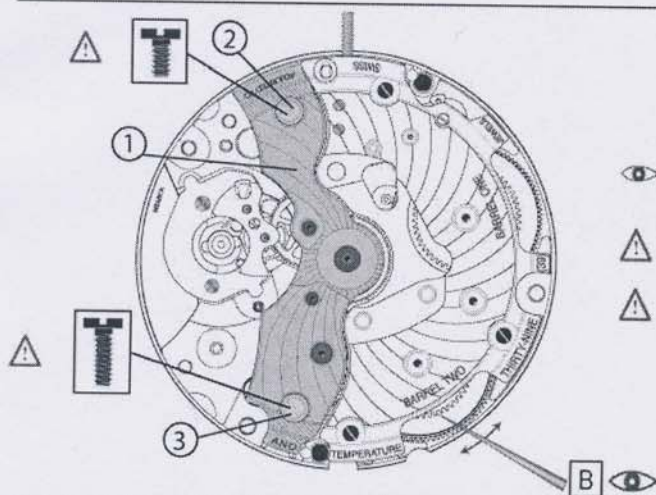

Wheel train bridge assembly

- A. Fit the wheel train bridge ①.
- 👁 B. Check wheel train clearance (move barrel two slightly).
- ⚠ C. Tighten the screw (short) ②.
- ⚠ D. Tighten the screw (long) ③.

Movement holder	Wheel train bridge, pre-assembled	Screw for wheel train bridge (short)	Screw for wheel train bridge (long)
Ref. 506 0058	①	②	③
	Ref. 1004818	Ref. 3535	Ref. 3534



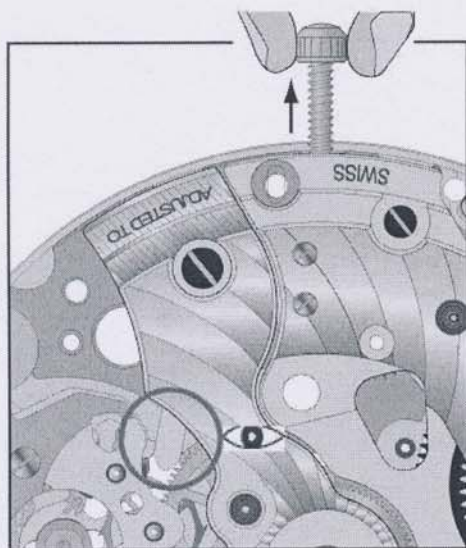

Stop lever function check

A. Pull the stem out fully.

👁 B. The stop lever should appear (see circled in green).

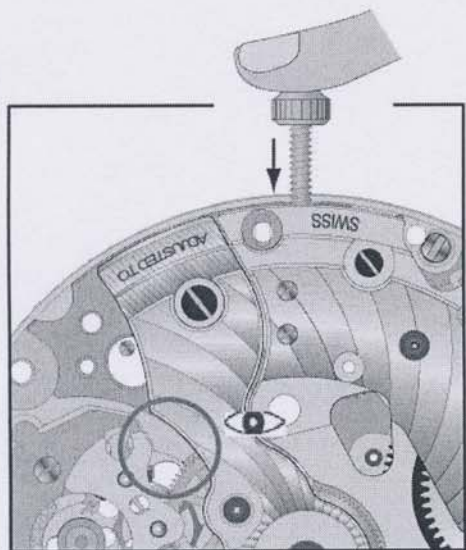

C. Push the stem in fully.

👁 D. The stop lever should disappear (see circled in green).

Movement holder
Ref. 506 0058

- Moebius SYNT HP-500
- ▽ Moebius SYNT-A-LUBE 9010
- ∞ Moebius SYNT HP-1300 Sans Colorant

Wheel train and escapement lubrication



● A. Lubricate on wheel train side.





● B. Lubricate on dial side.

● C. Lubricate the escapement, see page 27.

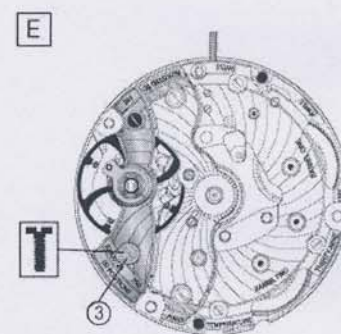
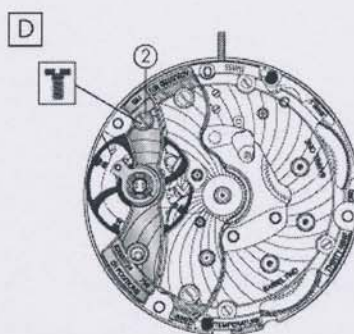
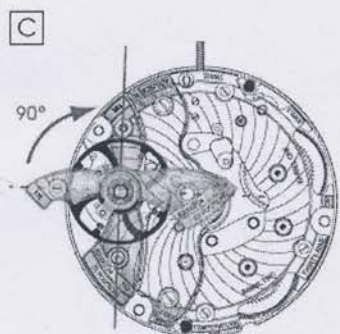
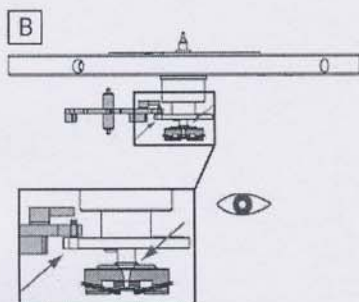
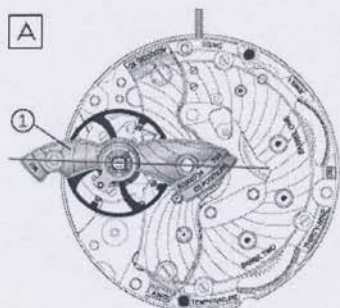
Balance fitting



- A Insert the balance bridge ①, with the number of the movement facing the centre of the movement.
- B Check the correct balance position. The pivots must be accurately fit into the shock-absorbers.
- C Turn the bridge gently to its normal position.
- D Tighten the screw (short) ②.
- E Tighten the screw (long) ③.

Movement holder	Balance with timing screws	Screw for balance bridge	Screw for balance bridge
Ref. 506 0058	①	②	③
	Ref. 4005119 + Ref. 1005818	Ref. 3535	Ref. 3536
			
	-----	T	T

Moebius SYNT-A-LUBE 9010

Shock-absorber lubrication

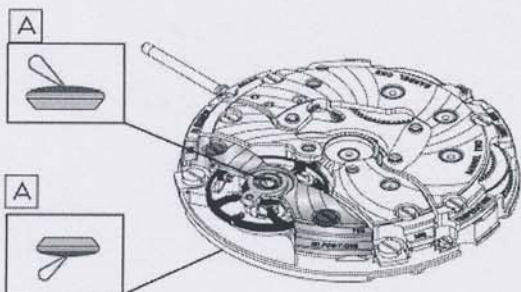

- A** Lubricate the two shock-absorbers.
- B.** Fit the two shock-absorbers.

Movement holder	In-setting, upper	In-setting, lower	Cap jewel, upper	Cap jewel, lower	Shock-absorber spring, upper	Shock-absorber spring, lower
Ref. 506 0058	①	②	③	④	⑤	⑥
	Ref. 70640	Ref. 70641	Ref. 70900	Ref. 70901	Ref. 78004	Ref. 78005
	-----	-----	-----	-----	-----	-----

Checking and adjusting the balance endshake

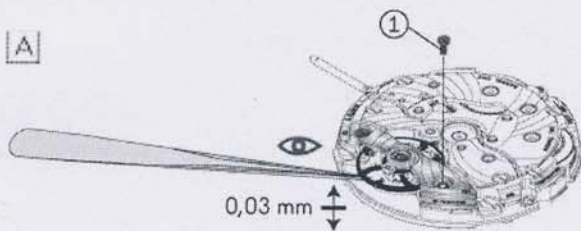

- A** Check the endshake. (target value: 0.03 mm).

Correct the endshake:

- B.** Remove the (long) screw ①.
- C** Turn the balance bridge adjustment nut using a screwdriver ②.
- D.** Tighten the (long) screw ①.

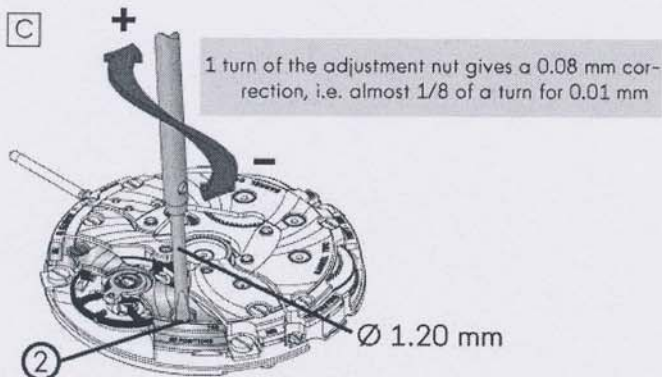

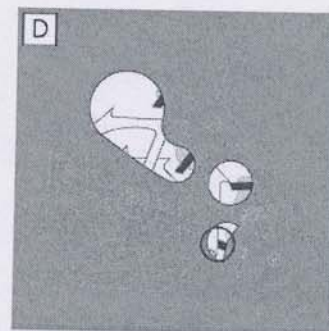
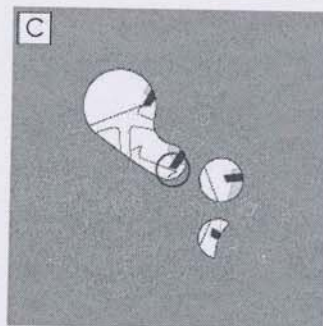
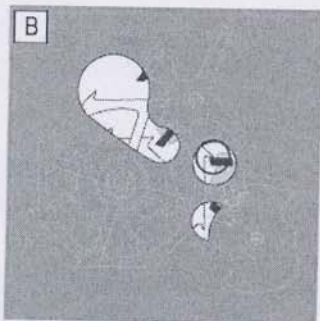
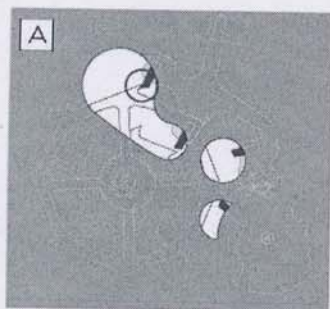

Escapement function check

- ⚠ All 8 teeth of the escape wheel must fall directly on the locking face of the pallet.
- ⚠ All 8 teeth of the escape wheel must fall directly on the locking face of the pallet.
- ⚠ The tip of the impulse pallet must pass all 8 teeth of the pinion without touching!
- ⚠ The tip of the impulse pallet must pass all 8 teeth of the pinion without touching!

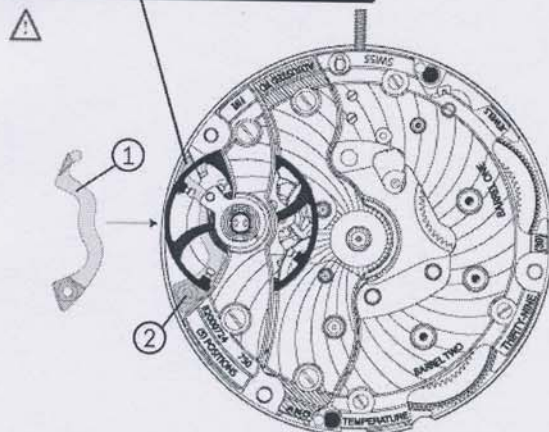
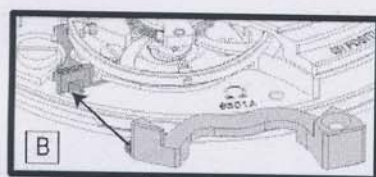

Tool for checking the coaxial escapement functions

Ref. 506 0055



Limitation bridge assembly

- A. Fit the limitation bridge ①.
- ⚠ B. Engage the limitation bridge nose in its housing.
- C. Tighten the screw ②.

Movement holder	Limitation bridge	Screw for limitation bridge
Ref. 506 0058	①	②
	Ref. 10066	Ref. 3548
		
	-----	

- Moebius 9504
- ▽ Moebius SYNT-A-LUBE 9010
- ▽ Moebius SYNT-A-LUBE 9010
- ◊ Moebius SYNT HP-1300 Sans Colorant
- ◊ Moebius SYNT HP-1300 Sans Colorant

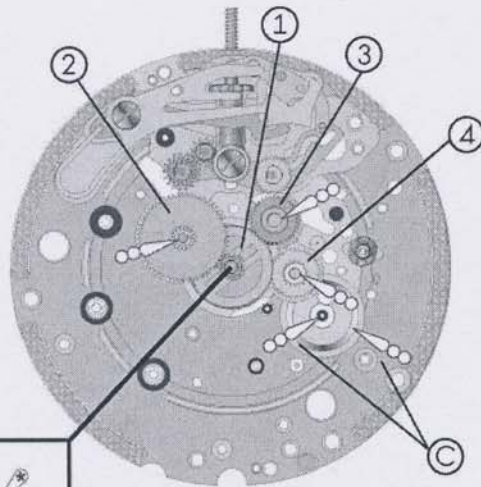

Mechanism 3 assembly

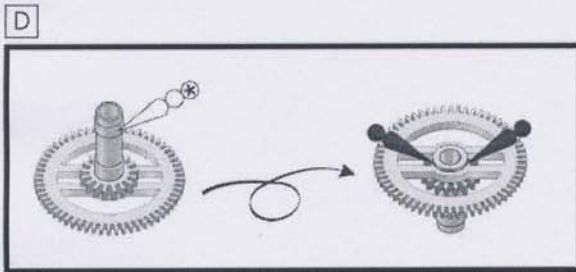

- Ⓐ Lubricate the centre tube.
- Ⓑ Lubricate the three studs of minute wheel ②, intermediate wheel for additional hour wheel ③ and intermediate date wheel ④.
- Ⓒ Lubricate the jewel and the date indicator driving wheel fillet.
- Ⓓ Lubricate the cannon pinion with driving wheel ①.
- E. Fit the cannon pinion with driving wheel ①.
- F. Fit the minute wheel ②.
- G. Fit the intermediate wheel for additional hour wheel ③.
- H. Fit the intermediate date wheel ④.







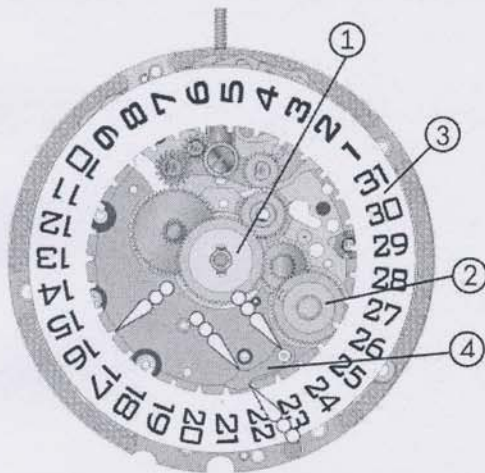
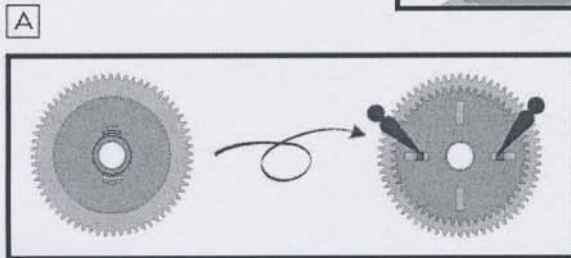
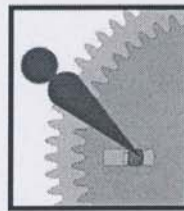

Movement holder	Cannon pinion with driving wheel	Minute wheel	Intermediate wheel for additional hour wheel	Intermediate date wheel
	①	②	③	④
	Ref. 3108301	Ref. 31041	Ref. 35079	Ref. 33011
Ref. 506 0058				

 Moebius 9504
 Moebius SYNT HP-1300 Sans Colorant

Mechanism 4 assembly + date indicator

-  A. Lubricate the hour wheel ①.
-  B. Lubricate the date jumper stud ④.
- C. Fit the hour wheel ①.
- D. Fit the date indicator driving wheel ②.
- E. Fit the date indicator ③.
- F. Fit the date jumper ④.
-  G. Lubricate the date jumper ④ and the date indicator ③.



Movement holder	Hour wheel	Date indicator driving wheel	Date indicator	Date jumper
	①	②	③	④
	Ref. 3104601	Ref. 33020	Ref. 9144*	Ref. 53080
Ref. 506 0058				
		-----	-----	-----

Moebius SYNT HP-1300 Sans Colorant

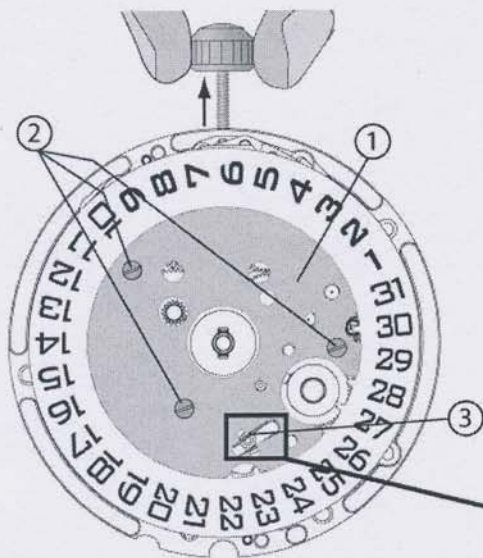

Maintaining plate fitting

- A. Fit the date mechanism maintaining plate ①.
- B. Tighten the three screws ②.
- C. Fit the date jumper spring ③.
- D. Pull the stem into position 2 and check forward and backward date jumps.

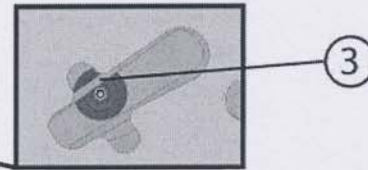

Movement holder	Date mechanism maintaining plate	Date mechanism maintaining plate screw	Date jumper spring
Ref. 506 0058	①	②	③
	Ref. 13101	Ref. 3543	Ref. 6303019
	-----		-----

Lower automatic bridge assembly

- A. Fit the two wig-wag pinions ②.
- B. Fit and slide the wig-wag pinion spring ③ under the tube foot.
- C. Fit the reduction wheel ④.
- D. Fit the barrel one driving wheel ⑤.
- E. Fit the stop pinion ⑥.
- F. Fit the intermediate winding wheel ⑦.
- G. Lubricate the spring for wig-wag pinions ③ and wig-wag pinions teeth ②.

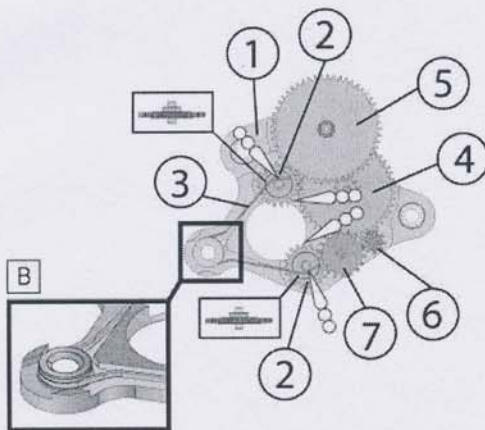

Holder	Lower automatic bridge, pre-assembled	Wig-wag pinion	Spring for wig-wag pinion	Reduction wheel	Driving wheel for barrel one	Stop pinion	Intermediate winding wheel
Ref. 506 0056	①	②	③	④	⑤	⑥	⑦
	Ref. 1205018	Ref. 32104	Ref. 62062	Ref. 32031	Ref. 31066	Ref. 32105	Ref. 32037
	-----		-----			-----	-----

Moebius SYNT HP-1300 Sans Colorant

Upper automatic bridge assembly

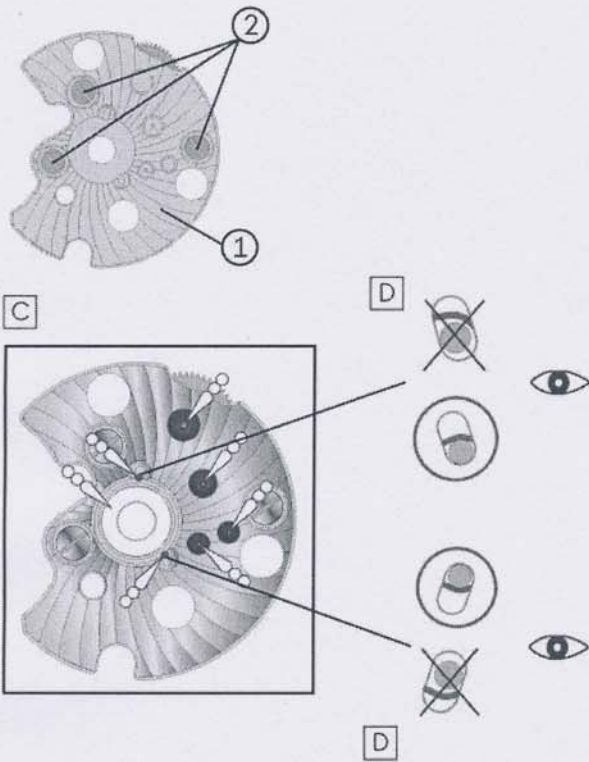

A. Fit the assembled upper automatic bridge ①.

B. Tighten the three screws (grey) ②.

Lubricate the pre-assembled upper automatic bridge.



Check the tension on the wig-wag pinion spring.

Holder	Upper automatic bridge, pre-assembled	Screw for pre-assembled upper automatic bridge
Ref. 506 0056	①	②
	Ref. 1203018	Ref. 3541

Moebius SYNT HP-1300 Sans Colorant

Fitting automatic bridge to oscillating weight and lubrication

- A. Fit the oscillating weight \odot to the holder.
- B. Reverse the pre-assembled upper automatic bridge and fit it to the oscillating weight \odot .

  Lubricate the lower side.

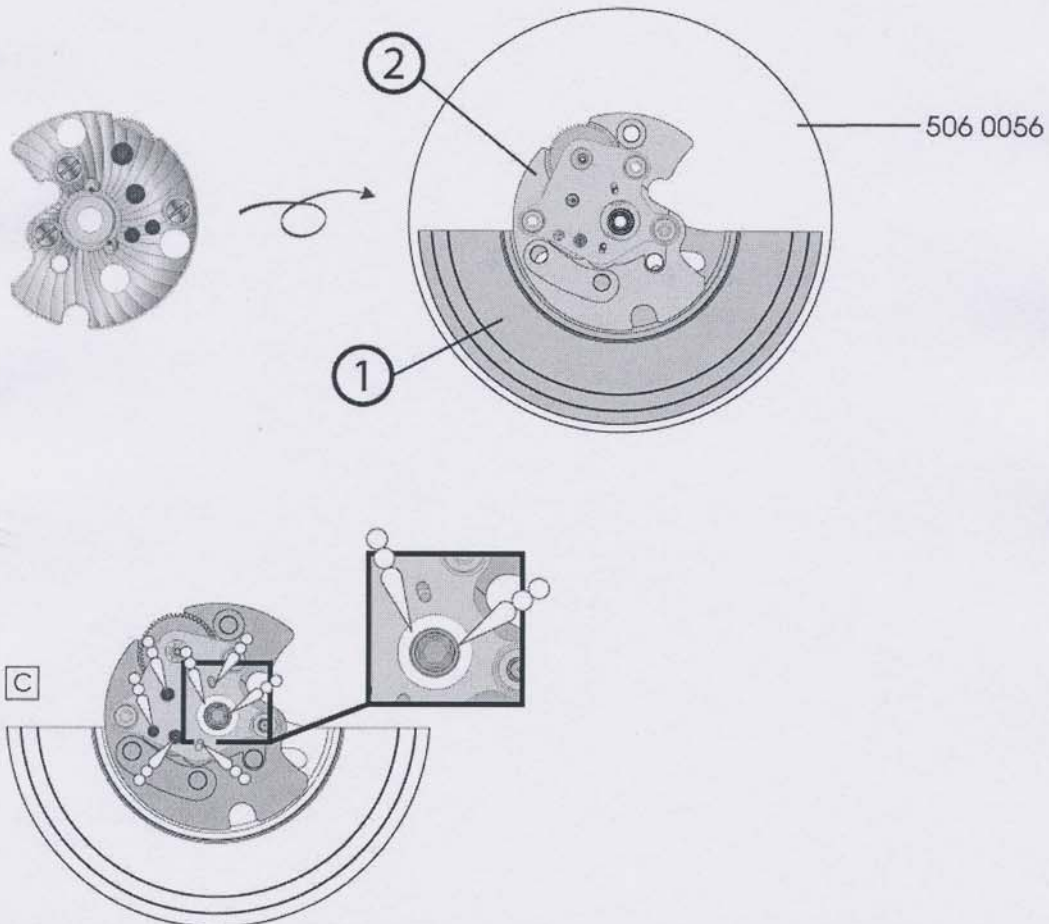

Support
Ref. 506 0056

Oscillating weight pinion assembly

A. Fit the oscillating weight pinion ①.

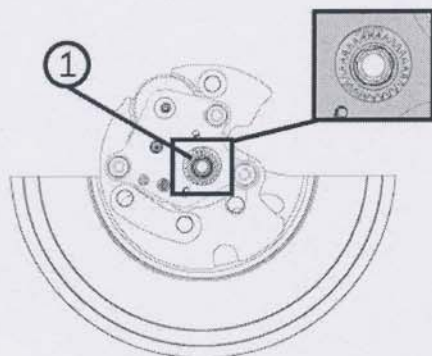



Support	Oscillating weight pinion
Ref. 506 0056	①
	Ref. 32100
	

Oscillating weight bolt slide fitting

A. Fit the oscillating weight bolt ① using tweezers.

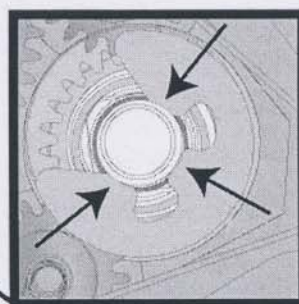
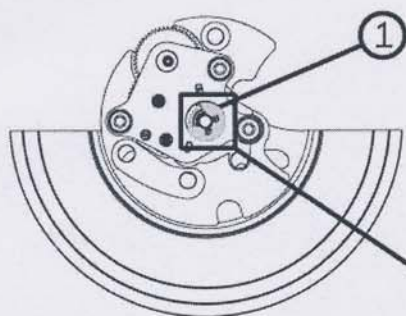
 B. Check the position.



Support	Oscillating weight bolt
Ref. 506 0056	①
	Ref. 52120
	

 Moebius SYNT HP-1300 Sans Colorant

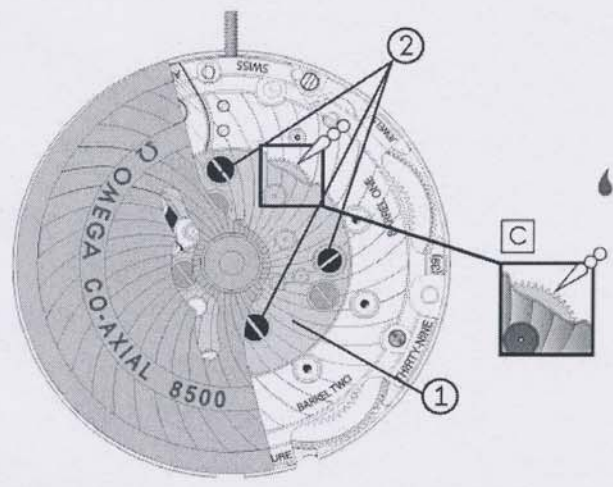



Assembled automatic bridge assembly





















A. Fit the assembled automatic bridge ①.

B. Tighten the three screws (black) ②.

 Lubricate the teeth of driving wheel for barrel one.

Movement holder	Upper automatic bridge with oscillating weight	Screw for pre-assembled upper automatic bridge
Ref. 506 0058	①	②
		Ref. 3542
	-----	
		

Spare parts list

Main plate, pre-assembled		Version	Reference	Barrel two, complete		Version	Reference
	8500A	7228500A1002071			8500A	7228500A20011	
	8501A	7228501A1002071			8501A		
Barrel bridge, pre-assembled		Version	Reference	Barrel drum one		Version	Reference
	8500A	7228500A1004118			8500A	7228500A20040	
	8501A				8501A		
Wheel train bridge, pre-assembled		Version	Reference	Barrel cover two		Version	Reference
	8500A	7228500A1004818			8500A	7228500A20041	
	8501A				8501A		
Pallet fork bridge (with serial number), pre-assembled		Version	Reference	Barrel cover one		Version	Reference
	8500A	7228500A1005718			8500A	7228500A20050	
	8501A				8501A		
Balance bridge (with serial number), pre-assembled		Version	Reference	Barrel cover two		Version	Reference
	8500A	7228500A1005818			8500A	7228500A20051	
	8501A	7228501A1005818			8501A		
Limitation bridge		Version	Reference	Barrel arbour one		Version	Reference
	8500A	7228500A10066			8500A	7228500A20060	
	8501A				8501A		
Upper automatic bridge pre-assembled		Version	Reference	Barrel arbour two		Version	Reference
	8500A	7228500A1203018			8500A	7228500A20061	
	8501A				8501A		
Lower automatic bridge, pre-assembled		Version	Reference	Mainspring with bridle		Version	Reference
	8500A	7228500A1205018			8500A	7228500A2010019	
	8501A				8501A		
Date mechanism maintaining plate		Version	Reference	Slipping mainspring		Version	Reference
	8500A	7228500A13101			8500A	7228500A20101	
	8501A				8501A		
Barrel one, complete		Version	Reference	Oscillating weight, pre-assembled		Version	Reference
	8500A	7228500A20010			8500A	7228500A2201018	
	8501A				8501A	7228501A2201018	

Spare parts list

Part Name	Calibre	Reference	Part Name	Calibre	Reference
	8500A	7228500A30014		8500A	7228500A32037
	8501A			8501A	
	8500A	7228500A30025		8500A	7228500A32031
	8501A			8501A	
	8500A	7228500A30027*		8500A	7228500A32100
	8501A			8501A	
	8500A	7228500A30039		8500A	7228500A32104
	8501A			8501A	
	8500A	7228500A3004019		8500A	7228500A32105
	8501A			8501A	
	8500A	7228500A31020		8500A	7228500A33011
	8501A			8501A	
	8500A	7228500A31023		8500A	7228500A33020
	8501A			8501A	
	8500A	7228500A31041		8500A	7228500A35079
	8501A			8501A	
	8500A	7228500A31046*		8500A	7228500A36051
	8501A			8501A	
	8500A	7228500A31066		8500A	7228500A40010
	8501A			8501A	
	8500A	7228500A31083*		8500A	7228500A4005119
	8501A			8501A	
	8500A	7228500A3208319		8500A	7228500A40200
	8501A			8501A	
	8500A	7228500A31120		8500A	7228500A51010
	8501A			8501A	
	8500A	7228500A31121		8500A	7228500A51050
	8501A			8501A	
	8500A	7228500A32029		8500A	7228500A5108018
	8501A			8501A	

Spare parts list

Setting lever jumper	Calibre	Reference	Shock-absorber spring, upper	Calibre	Reference
	8500A	7228500A51091		8500A	7228500A78004
	8501A			8501A	
Click	Calibre	Reference	Shock-absorber spring, lower	Calibre	Reference
	8500A	7228500A51120		8500A	7228500A78005
	8501A			8501A	
Oscillating weight bolt	Calibre	Reference	Adjustment nut for balance bridge, pre-assembled	Calibre	Reference
	8500A	7228500A52120		8500A	7228500A8070318
	8501A			8501A	
Date jumper	Calibre	Reference	Crown wheel core	Calibre	Reference
	8500A	7228500A53080		8500A	7228500A81136
	8501A			8501A	
Operating lever for date corrector, pre-assembled	Calibre	Reference	Date indicator	Calibre	Reference
	8500A	7228500A5302218		8500A	7228500A9144* * Several versions available
	8501A			8501A	7228501A9144* * Several versions available
Stop lever	Calibre	Reference	Screw for barrel bridge	Calibre	Reference
	8500A	7228500A56070		8500A	7228500A3534
	8501A			8501A	
Click spring	Calibre	Reference	Screw for wheel train bridge	Calibre	Reference
	8500A	7228500A61080		8500A	7228500A3534
	8501A			8501A	
Spring for wig-wag pinion	Calibre	Reference	Screw for wheel train bridge	Calibre	Reference
	8500A	7228500A62062		8500A	7228500A3535
	8501A			8501A	
Date jumper spring	Calibre	Reference	Screw for balance bridge	Calibre	Reference
	8500A	7228500A6303019		8500A	7228500A3535
	8501A			8501A	
Shock-absorber, upper	Calibre	Reference	Screw for balance bridge	Calibre	Reference
	8500A	7228500A70530		8500A	7228500A3536
	8501A			8501A	
Shock-absorber, lower	Calibre	Reference	Screw for pallet fork bridge	Calibre	Reference
	8500A	7228500A70531		8500A	7228500A3537
	8501A			8501A	
In-setting, upper	Calibre	Reference	Screw for pallet fork bridge	Calibre	Reference
	8500A	7228500A70640		8500A	7228500A3538
	8501A			8501A	
In-setting, lower	Calibre	Reference	Screw for intermediate corrector wheel	Calibre	Reference
	8500A	7228500A70641		8500A	7228500A3539
	8501A			8501A	
Cap jewel, upper	Calibre	Reference	Screw for setting lever jumper	Calibre	Reference
	8500A	7228500A70900		8500A	7228500A3540
	8501A			8501A	
Cap jewel, lower	Calibre	Reference	Screw for automatic device	Calibre	Reference
	8500A	7228500A70901		8500A	7228500A3541
	8501A			8501A	

Screw for lower automatic bridge	Calibre	Reference
▼	8500A	7228500A3542
	8501A	
Screw for date indicator maintaining plate	Calibre	Reference
▬	8500A	7228500A3543
	8501A	
Click screw	Calibre	Reference
▼	8500A	7228500A3544
	8501A	
Crown wheel core screw	Calibre	Reference
▬	8500A	7228500A3545
	8501A	
Dial fastener	Calibre	Reference
▼	8500A	7228500A3546
	8501A	
Stud screw	Calibre	Reference
•	8500A	7228500A3547
	8501A	
Screw for limitation bridge	Calibre	Reference
┆	8500A	7228500A3548
	8501A	
Kit black screw cal. 8500	Calibre	Reference
(4x) ▼	8500A	7228500A9999
(2x) ▼	8501A	
(1x) ▼		
(3x) ▼		



1.0 Mandatory tools

Tools	Ref.
Torx timing key	506 0044
Tool for checking the coaxial escapement functions	506 0055
Holder for assembly of automatic device	506 0056
Holder for barrel bridge assembly	506 0057
Movement holder with pushers, 2-side use	506 0058
Mainspring winder	506 0059
Movement holder for hand setting	507 0104

2.0 Dual barrel systems

Major points

The motor component includes two barrels ref. 20010 & 20011 and a transmission wheel for ratchet wheels ref. 3208319. Barrel one ref. 20010 is with fixed spring. Barrel two ref. 20011 is with slipping spring. An anti-wear coating is applied to its inside wall to guarantee a very long life. The upper winding torque on barrel one is slightly lower than the barrel two torque. The two barrels are series mounted. Their revolutions are added together.

2.1 Manual winding principle (Fig. 2.1)

The system is wound by the barrel one driving wheel ref. 31066 which meshes with the barrel one teeth. This barrel has a ratchet wheel ref. 31020 which meshes with the ratchet wheel transmission wheel ref. 3203819 this in turn meshes with the ratchet wheel ref. 31020 held by barrel two.

2.2 Automatic winding principle (Fig. 2.1)

For winding with the automatic device, barrel one is wound by the driving wheel on the ratchet wheel transmission wheel ref. 31066. The barrel one torque is transmitted to barrel two by the ratchet wheels and ratchet wheel transmission wheel. There is balanced torque between the two barrels during winding.

The upper winding torque on barrel one (mainspring with bridle) is transmitted directly to barrel two until the slipping mainspring slips.

2.3 Unwinding principle (Fig. 2.3)

Barrel two meshes with the first wheel ref. 30014. The barrel two torque decreases as the wheel train rotates. When the barrel two torque has decreased to the same level as the barrel one torque, the linkage system between the two barrels will produce a balanced torque. The two barrels will then unwind simultaneously.

Fig. 2.1

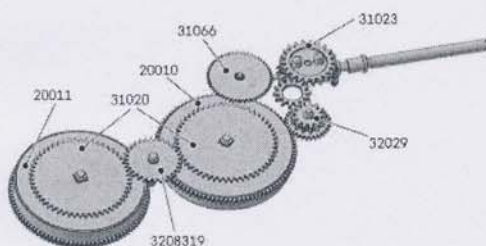

Fig. 2.3

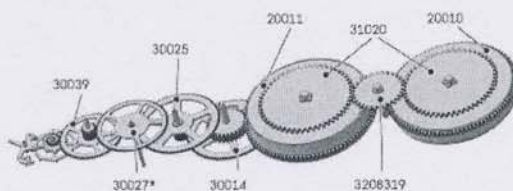

Fig. 3.0

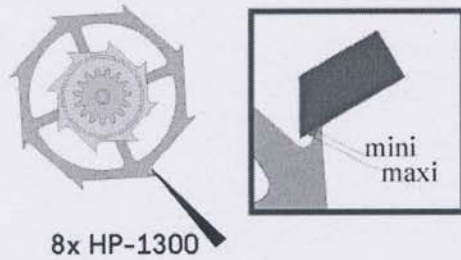
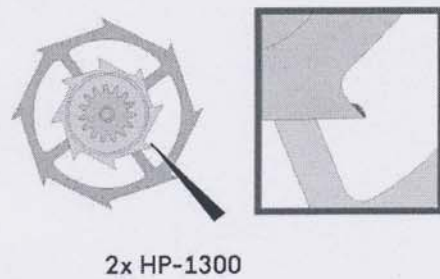

Fig. 3.0.1



3.0 Lubrication of the escapement

The escapement lubrication should be inspected under a microscope. We recommend lubricating the escapement directly under a microscope.

Escapement wheel:

Place a tiny drop of HP-1300 on the tip of one tooth and then move the escapement forward by one tooth. Repeat this step eight times so that all the teeth are lubricated.

Quantity:

Lubricant quantity tolerances are shown above (see Fig. 3.0).

Pinion:

Place a tiny drop of HP-1300 on the tip of one pinion tooth. Once you have placed the first drop, move the escapement forward by three or four teeth. Place another drop on a second tooth.

Quantity:

The required quantity of lubricant is indicated in the diagram (see Fig. 3.0.1).

Fig. 4.0

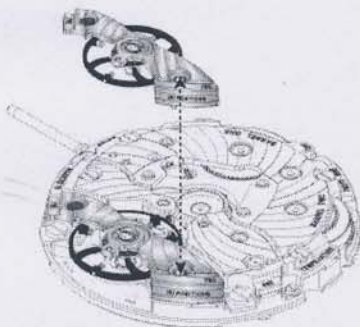

4.0 Balance bridge

The balance bridge is a cross bridge fitted to a fixed seat (side opposite the movement number) and an upper, mobile seat (movement number side) used to adjust the balance end-shake. As the balance roller is located under the pallet fork, special care should be taken when fitting-in the balance together with the bridge.

Fig. 5.01

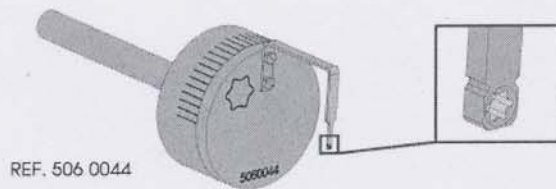

5.0 Free-sprung balance

The free-sprung balance ref. 4005119 has four micro timing-screws located inside the balance rim. These screws work in pairs, in opposite positions.

The screw head shape has been improved to make it easier to access the screw with the timing key. The key can be inserted every 60 degrees.

The engraving on the two adjoining balance arms marks the position of each pair of screws. One arm is engraved Ω , the other OMEGA.

Fig. 5.02

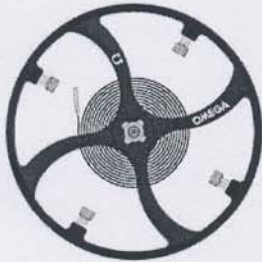

Fig. 5.03



A rate deviation is corrected by moving one opposed pair of timing-screws (towards the centre of the balance, Figure 5.02), which reduces its moment of inertia and makes it running faster.

A gain of time is corrected by moving one opposed pair of timing-screws (towards the balance rim, Figure 5.03), which increases its moment of inertia and makes it running slower.

Fig. 5.1

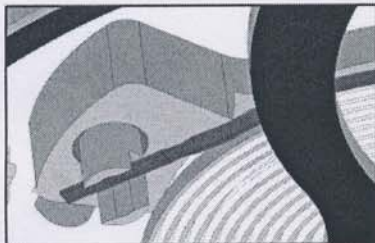

5.1 Fixation of the hairspring to the stud

The hairspring at its end is twisted 90° to increase rate stability as well as the hold of the hairspring in the stud. This geometry defines the active length of the balance-spring exactly.

The length of the twisted part does not influence the active length of the spring. The frequency is not influenced by inaccuracies due to glue fixation problems. This system is patented. **Do not touch this part of the mainspring.**

Fig. 6.0

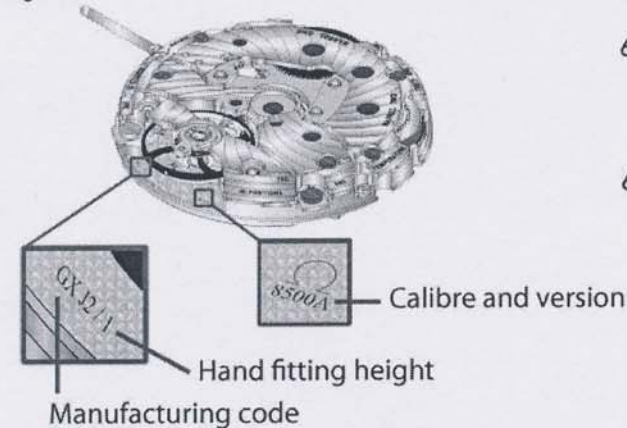

6.0 Information on the movement

6.0.1 Calibre, version, manufacturing code and height of hands

As shown in Figure 6.0

6.0.2 Ordering starred parts

Movement spare parts should be ordered as follows, in Figure 6.0

Example 7228500A310831

The final figure indicates the height of the cannon pinion with driving wheel.

Fig. 7.0

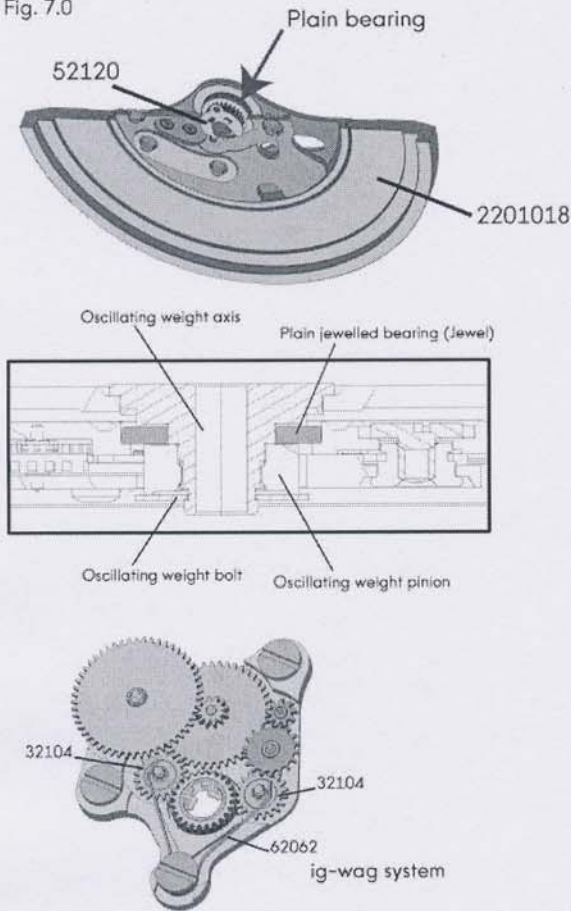

7.0 Automatic system

The automatic system winds the watch by rotating the oscillating weight ref. 2201018 in both directions. The oscillating weight pivots on a plain jewelled bearing (jewel in ZrO_2 , zirconium oxide), without noise or vibration. The weight has an open hole to absorb shocks without damaging the bearing.

The oscillating weight ref. 2201018 is fixed to the automatic device using the oscillating weight bolt ref. 52120. There is no risk of it becoming unscrewed.

Two wig-wag pinions ref. 32104 reverse the system; these are held in place by a wig-wag pinion spring ref. 62062.

The entire system may be dismantled, cleaned and assembled, with no need for special lubrication treatments.

The automatic system is modular and may be removed from the movement. It is fixed to the movement with three black screws ref. 3541.

Fig. 8.0

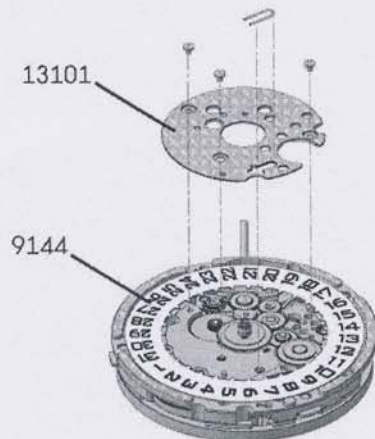

8.0 Calendar

The date indicator plate ref. 144 is held by a date mechanism maintaining plate ref. 13101. This plate guides the date indicator plate over almost the entire periphery.

9.0 Crown functions

The crown has three positions:











1. **Normal position**, when worn: water-resistance is ensured by the crown being close to the case.
Occasional winding: wind the watch by means of the crown (position 1), if the watch has not been worn for sixty hours or more.

2. **Time zone**: pull the crown out to the intermediate position 2. Move the crown forwards or backwards; the hour hand will jump forwards or backwards, one hour at a time. Push the crown back to position 1.

Correcting the date: the date is corrected forwards or backwards by crossing midnight with the hour hand. Push the crown back to position 1. Caution: when correcting the time zone backwards, you must return to 7 p.m. to ensure that the date changes entirely.

3. **Hand-setting**: hours-minutes-seconds.
Pull the crown completely out to position 3. The second hand stops. Turn the crown forwards or backwards until the hands are in the desired position. Synchronise the seconds by pushing the crown into position 1 at the time signal.

10.0 Components that must not be epilam-treated after cleaning

Description	Reference	
Balance assembled on the balance bridge	Ref. 4005119 + Ref. 1005818	
Complete balance	Ref. 4005119	
Pallet fork	Ref. 40010	
In-setting for shock-absorber, upper *	Ref. 70640	
In-setting for shock-absorber, lower *	Ref. 70641	
Pallet fork bridge	Ref. 1005718	
Barrel one, complete **	Ref. 20010	
Mainspring with bridle	Ref. 2010019	
Barrel two, complete **	Ref. 20011	
Slipping mainspring	Ref. 20101	



* Do not treat the shock-absorber settings with epilam; the cap jewels should however be treated.

** Do not treat the complete barrels with epilam, only the drums, covers and arbours.

11.0 Technical data

11.1 Runners for hand setting and hand setting force

Description	Movement holder for hand setting	No of runners for hand setting	Minimum force (N)	Maximum force (N)	Support (jewel)
Hour hand	507 0104	5	10	50	No
Minute hand		2	10	50	No
Second hand		1	10	30	Yes

11.2 Winding time on Cyclotest (4 rpm)

- Movement stopped (stem in position 3): 4 hours 10 minutes.
- Movement running (stem in position 1): 4 hours 35 minutes.

11.3 Instantaneous rate

11.3.1 Control of instantaneous rate

Please consult Working Instructions 5 and 28 for instructions and

Special parameter settings

Instrument type	Coaxial, 3.5 Hz calibres	Comments
Former Witschi instruments - Watch Expert (red case) - Wicomètre Professionnel - Chronoscope M1 (former version)	Lift angle, set to 38°	3.5 Hz calibres: The frequency parameters (25'200 A/h) should be set manually so that instant-on is displayed correctly.
	The amplitude is not measured correctly	
New Witschi instruments - Watch Expert II (white case) - Chronoscope M1 (updated version)	Lift angle, set to 38°	Test mode: Parameters must be set for «Spe1»!
	All measurements are correct	

11.3.2 Adjustment of the rate

Fig. 11.3.2

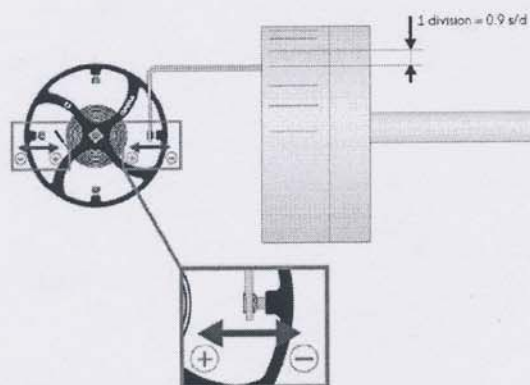

A special timing key tool has been developed to adjust the rate by means of timing-screws located inside the balance rim. This adjustment can even be performed when the movement is cased in. A line on the scale on the outside of the tool corresponds to 1.1 s/d (Figure 11.3.2.).

The correction is always made on the pair of opposed screws located between the non-engraved arms. The other pair of screws between the engraved arms is used for timing during production.



Timing corrections must always be made to the pair of timing-screws between the two, non-engraved arms to prevent an unbalance of the balance.

Fig. 12.0

12.0 Disassembling

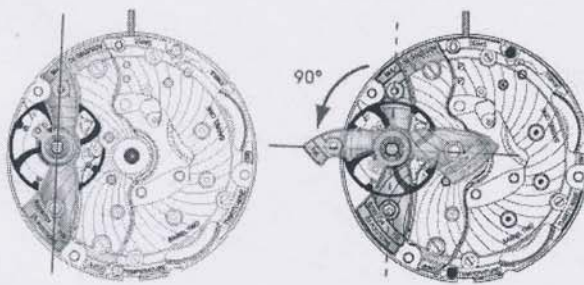

12.1 Disassembling the balance bridge

The balance bridge is always removed in the reverse direction of the procedure on page 12. The bridge must be turned towards the centre of movement to avoid damaging the balance during the dismantling operation. The bridge may be removed without danger in this position.

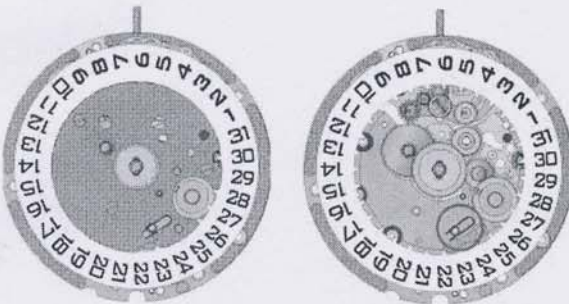
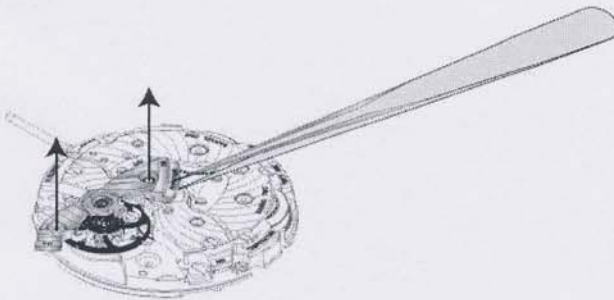

12.2 Disassembling the date mechanism maintaining plate.

The spring remains on the plate once the date mechanism maintaining plate has been removed.

12.3 Components to not be cleaned

All the black screws	Ref. 3534 (4x)	⚡
	Ref. 3535 (2x)	⚡
	Ref. 3536 (1x)	⚡
	Ref. 3541 (3x)	⚡

Spring for wig-wag pinion	Ref. 62062	
---------------------------	------------	--



Do not clean inside the machine, this may deform it.



Modifications of version of Technical Guides

Versions of Technical Guide				
Date of first edition:	24.11.2006	Version A	Made by:	Pelrom
Date of second edition:	19.02.2007	Version B		
Date of last edition:	04.05.2007	Version C		

Modifications of Technical Guide version B	
Old (version A)	New (version B)
_____	Page 3: Components to not be cleaned
Page 5: (Plastic stick or brass tweezers)	Page 5: (Plastic stick)
_____	Page 9: Add lubrication point for stop lever
Page 13 et 14: Reverse of content + add of fitting stages; Escapement function check	
_____	Page 16: Add of additional view
_____	Page 17: Check position of stop pinion
_____	Page 18: Add additional check
_____	Page 19: Check has been moved into page 18
_____	Page 25: Add: «Kit black screw cal. 8500»
_____	Page 33: Add: 12.3 Components to not be cleaned

Modifications of Technical Guide version C																							
Old (version B)	New (version C)																						
Page 32: Hand setting force	Page 32; Add: Runners for hand setting and hand setting force																						
<table border="1" style="width: 100%; border-collapse: collapse; text-align: center;"> <thead> <tr> <th style="width: 25%;">Designation</th> <th style="width: 15%;">Minimum force (N)</th> <th style="width: 15%;">Maximum force (N)</th> <th style="width: 45%;">Support (jewel)</th> </tr> </thead> <tbody> <tr> <td>Hour hand</td> <td>10</td> <td>50</td> <td>no</td> </tr> <tr> <td>Minutes hand</td> <td>10</td> <td>50</td> <td>no</td> </tr> <tr> <td>Seconds hand</td> <td>10</td> <td>30</td> <td>yes</td> </tr> </tbody> </table>	Designation	Minimum force (N)	Maximum force (N)	Support (jewel)	Hour hand	10	50	no	Minutes hand	10	50	no	Seconds hand	10	30	yes	<table border="1" style="width: 100%; border-collapse: collapse; text-align: center;"> <thead> <tr> <th style="width: 60%;">Movement holder for hand setting</th> <th style="width: 40%;">No of runners for hand setting</th> </tr> </thead> <tbody> <tr> <td rowspan="3" style="text-align: left;">507 0104</td> <td style="background-color: #cccccc;">5</td> </tr> <tr> <td style="background-color: #cccccc;">2</td> </tr> <tr> <td style="background-color: #cccccc;">1</td> </tr> </tbody> </table>	Movement holder for hand setting	No of runners for hand setting	507 0104	5	2	1
Designation	Minimum force (N)	Maximum force (N)	Support (jewel)																				
Hour hand	10	50	no																				
Minutes hand	10	50	no																				
Seconds hand	10	30	yes																				
Movement holder for hand setting	No of runners for hand setting																						
507 0104	5																						
	2																						
	1																						
Page 32: Ajustment of the rate: A line on the scale on the outside of the tool corresponds to 0.9 s/d	Page 32: Ajustment of the rate: A line on the scale on the outside of the tool corresponds to 1.1 s/d																						

