

## CALIBRE – KALIBER – CALIBRE 1270

<p><b>12''''</b> ø 27,60 mm</p>	
<p>Hauteur mouvement Werkhöhe Movement height</p>	<p>4,75 mm</p>
<p>Hauteur sur pile Höhe auf Batterie Height on battery</p> <p>Nombre de rubis / Anzahl Rubine / Number of jewels Fréquence / Frequenz / Frequency</p>	<p>5,00 mm</p> <p>22 32'768 Hz</p>

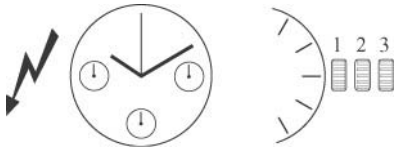
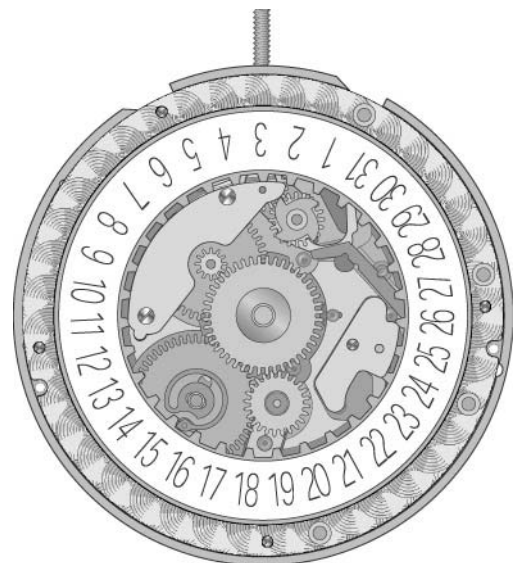

Français  
Deutsch  
English

## Informations générales

### Description

Mouvement quartz avec chronographe permettant la lecture de la seconde et de la fraction de seconde.

Avantages de la montre quartz:

- Précision.
- Montre toujours à l'heure même si elle n'est pas portée.

Avantages du chronographe avec remise à zéro mécanique:

- Déplacement des aiguilles instantané lors du retour à zéro. Ce système économise l'énergie de la pile puisque la remise à zéro est faite par un marteau.

### Arrêt automatique du chronographe

Afin de préserver l'autonomie de la pile, le chronographe est mis hors service après environ 11 heures de marche. Cette fonction est avantageuse au cas où le porteur laisserait le chronographe enclenché malencontreusement.

### Ne pas laver

Le pont de rouage (10.048)  
Le mobile de chronographe (35.010)  
Le circuit (20.550)  
Les deux bobines (20.590 et 20.593)  
L'isolateur de pile (20.651)  
L'indicateur de quantième (91.440)  
Les deux rotors (20.580 et 20.587)

### Outils spécifiques

Prte-mouvement (réf. 502 110 0241)  
Posage aiguilles (réf. 502 120 0241)

## Allgemeine Informationen

### Beschreibung

Chronograph - Quarzwerk auf dem Sekunden und Sekundenbruchteile abgelesen werden können.

Vorteile der Quarzuhr:

- Präzision.
- Uhrzeit stimmt immer, auch wenn die Uhr nicht getragen wird.

Vorteil des Chronographs mit mechanischer Nullstellung:

- Sofortiges Zurückspringen der Zeiger bei der Nullstellung. Durch dieses System wird Energie der Batterie gespart, da die Nullstellung über einen Herzhebel erfolgt.

### Automatisches Stoppen des Chronographs

Um die Lebensdauer der Batterie zu verlängern, wird der Chronograph nach ungefähr 11 Stunden ausser Funktion gesetzt. Dies erweist sich als nützlich wenn der Träger den Chronograph versehentlich laufen lässt.

### Nicht waschen

Räderwerkbrücke (10.048)  
Chronograph-Zentrumrad (35.010)  
Schaltung (20.550)  
Beide Spulen (20.590 und 20.593)  
Isolation für Batterie (20.651)  
Datumanzeiger (91.440)  
Beide Rotoren (20.580 und 20.587)

### Besonderes Werkzeug

Werkhalter (Ref. 502 110 0241)  
Werkhalter zum Zeiger setzen (Ref. 502 120 0241)

## General Information

### Description

Quartz chronograph movement for measuring seconds and fractions of seconds.

Advantages of the quartz watch:

- Precision.
- Correct time even if the watch is not worn.

Advantage of the chronograph with mechanical reset system:

- Immediate return of the hands when reset to zero. This system saves battery energy since the reset to zero is carried out by a hammer.

### Automatic stopping of the chronograph

In order to extend the lifetime of the battery, the chronograph stops after approximately 11 hours of running, which is useful when the chronograph is running inadvertently.

### Do not clean with liquid

Wheel train bridge (10.048)  
Chronograph wheel (35.010)  
Circuit (20.550)  
Both coils (20.590 and 20.593)  
Battery insulator (20.651)  
Date indicator (91.440)  
Both rotors (20.0580 and 20.587)

### Specific tools

Movement holder (ref. 502 110 0241)  
Movement holder for hands fitting (ref. 502 120 0241)

## Phase 1

### Montage côté cadran

(Liste des fournitures par ordre d'assemblage)

### Zusammenbau Zifferblattseite

(Bestandteilliste in Montager Reihenfolge)

### Dial side assembling

(Parts listed in order of assembly)

10.020	51.050
31.121	61.100
51.010	10.210
61.101	6204
51.081	51.090
51.080	6012

Huile fine  
Düninflüssiges Öl  
Fine oil



**Moebius 9010**

Huile épaisse, à viscosité élevée ou graisse  
Dickflüssiges, druckfestes Öl oder Fett  
Thick, pressure-resistant oil or grease



**Moebius 8141 D5**

Graisse  
Fett  
Grease



**Moebius 9501**



Ne pas laver  
Nicht waschen  
Do not clean with liquid

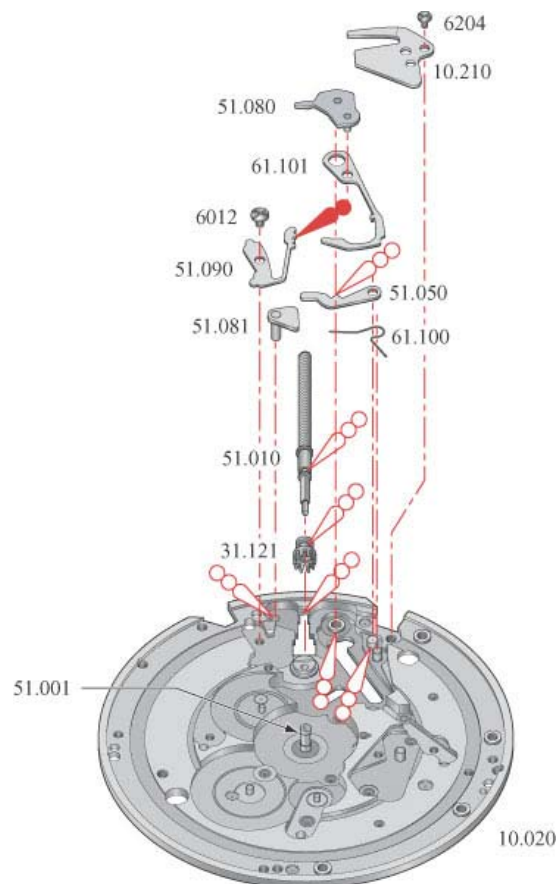

### Attention

- Le couvre-mécanisme (10.210) est positionné par une goupille et se glisse dans l'encoche du tenon de bascule de pignon coulant.

### Démontage

- Positionner le chronographe sur remise à zéro. Tige en position 1 (neutre).  
- Faire pivoter le couvre-mécanisme (10.210) pour le libérer du tenon.

### Achtung

- Die Deckplatte für Stelleinrichtung (10.210) wird durch einen Stift positioniert und muss in den Einschnitt des Zapfens für den Kupplungstriebhebel geschoben werden.

### Demontieren

- Chronograph auf Null stellen. Stellwelle in Position 1 (neutral).  
- Die Deckplatte für Stelleinrichtung (10.210) hin- und herbewegen um sie vom Zapfen zu lösen.

### Attention

- The position of the setting mechanism cover (10.210) is determined by a pin.  
- Slide the cover in the groove of the yoke stud.

### Disassembling

- Reset the chronograph to zero. Hand-setting stem in position 1 (neutral).  
- Move the setting mechanism cover (10.210) from one side to the other in order to loosen it from the stud.

## Phase2

**Montage de la partie électronique et des rouages**  
(Liste des fournitures par ordre d'assemblage)

**Zusammenbau des elektronischen Teils und des Räderwerks**

(Bestandteilliste in Montagereihenfolge)

**Assembling of the electric part and of the wheel train**

(Parts listed in order of assembly)

10.020	20.582	35.009	35.012
35.032	20.550	30.029	15.040
31.006	6011 2x	35.007	6011 2x
20.651	35.031	35.010	70.200 2x
20.583	20.587	35.013	

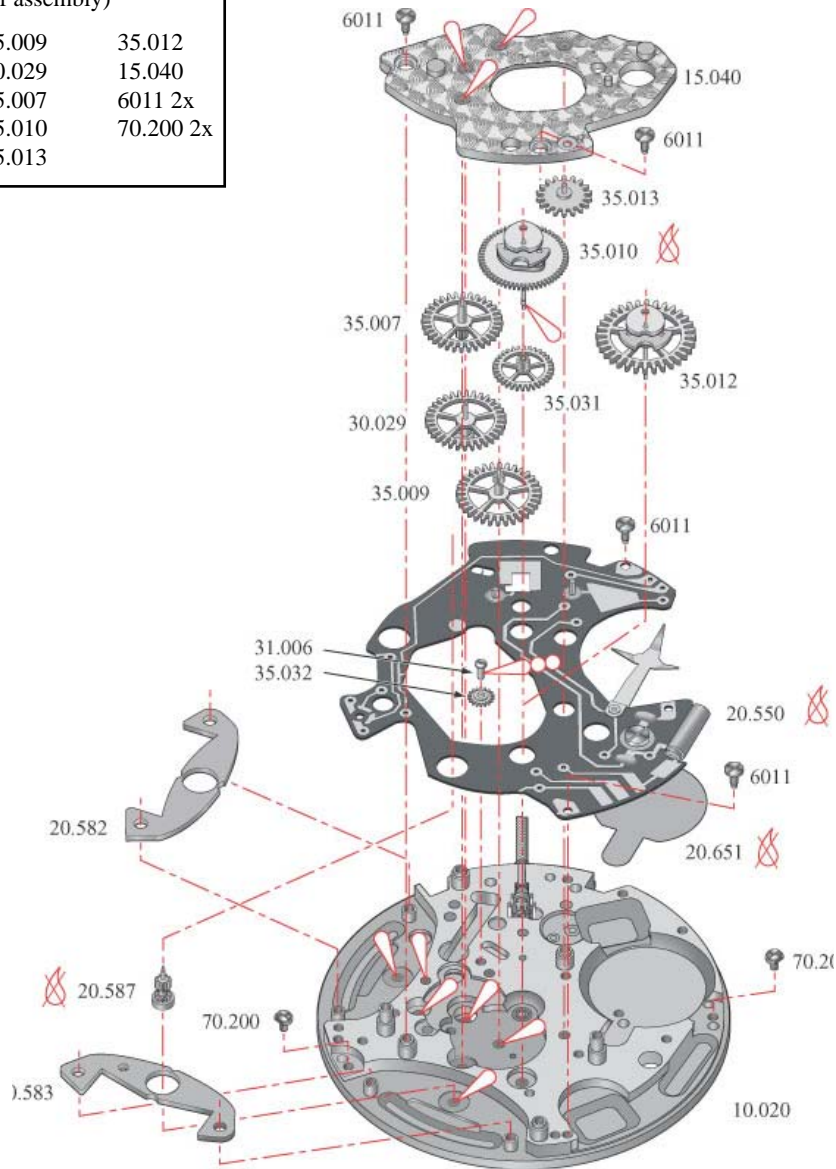

### Attention

- Le stator chronographe (20.583) se distingue par un trou supplémentaire et le rotor chronographe (20.587) par un pignon plus gros.
- La roue entraîneuse de chronographe 1 (35.007) se place pignon dessous côté platine. La roue entraîneuse du compteur d'heures (35.031) se monte pignon dessus.
- Position des stators selon l'éclaté.

### Achtung

- Der Chronograph-Stator (20.583) unterscheidet sich durch ein zusätzliches Loch, der Chronograph-Rotor (20.587) durch einen grösseren Trieb.
- Das Chronograph-Mitnehmerrad 1 (35.007) wird mit dem Trieb nach unten auf die Werkplatte gesetzt. Das Mitnehmerrad für Stundenzähler (35.031) wird mit dem Trieb nach oben montiert.
- Position der Statoren gemäss Zeichnung.

### Attention

- The chronograph stator (20.583) can be identified by its additional hole, the chronograph rotor (20.587) by its bigger pinion.
- Place the chronograph driving wheel 1 (35.007) with the pinion downward on mainplate. Assemble the hour counting driving wheel (35.031) with the pinion upward.
- Position of the stators according to drawing.

### Phase 3 + 4

#### Montage côté cadran

(Liste des fournitures par ordre d'assemblage)

#### Zusammenbau Zifferblattseite

(Bestandteilliste in Montager Reihenfolge)

#### Dial side assembling

(Parts listed in order of assembly)

10.020	51.050
31.121	61.100
51.010	10.210
61.101	6204
51.081	51.090
51.080	6012

 Huile fine  
Dünnflüssiges Öl  
Fine oil

**Moebius 9010**

 Huile épaisse, à viscosité élevée ou graisse  
Dickflüssiges, druckfestes Öl oder Fett  
Thick, pressure-resistant oil or grease

**Moebius 8141 D5**

 Graisse  
Fett  
Grease

**Moebius 9501**

 Ne pas laver  
Nicht waschen  
Do not clean with liquid

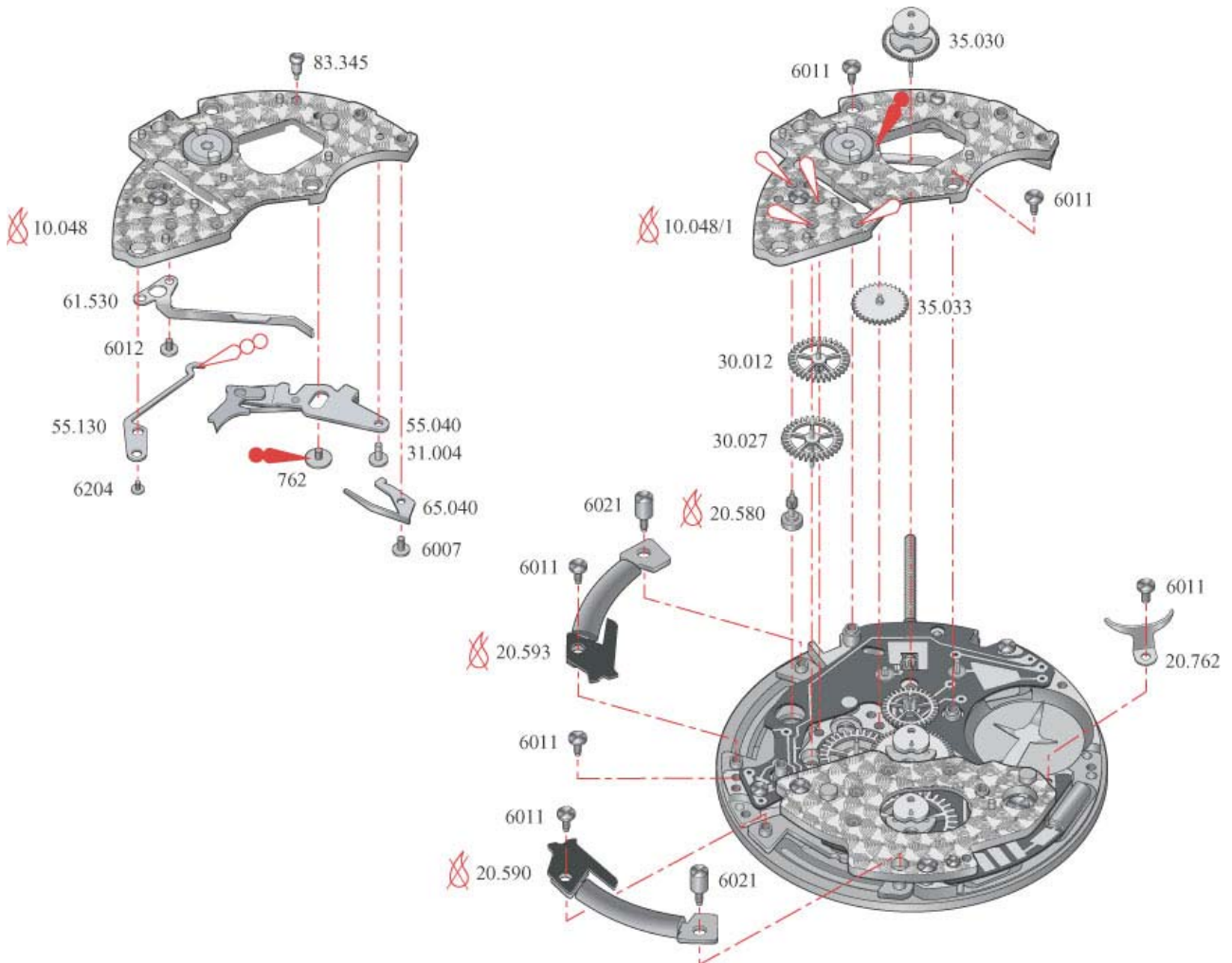

#### Attention

- Entreprendre les contrôles électriques de la position 1 (page 18) après l'assemblage de la phase 4.

- La roue à colonnes est lubrifiée et montée en production. Elle ne peut pas être démontée après rivetage.

#### Achtung

- Nach dem Zusammenbau der Phase 4 die elektrische Kontrollen des Messpunktes 1 (Seite 18) durchführen.

- Das Schaltrad (Kolonnenrad) wird in der Produktion geschmiert und montiert. Es kann nachträglich nicht demontiert werden.

#### Attention

- Make the electrical tests of position 1 (page 18) after the assembling of phase 4.

- The columns-wheel is lubricated and assembled during factory production. It cannot be disassembled afterwards.

## Phase 5

### Montage du mécanisme chronographe

(Liste des fournitures par ordre d'assemblage)

### Zusammenbau des Chronograph-Mechanismus

(Bestandteilliste in Montagereihenfolge)

### Assembling of the chronograph mechanism

(Parts listed in order of assembly)

55.143	55.047	55.281	6011 3x
6012	55.240	65.210	9917
55.144	55.344	65.170	
6012	65.261	15.041	

 Huile fine  
Dünflüssiges Öl  
Fine oil

**Moebius 9010**

 Huile épaisse, à viscosité élevée ou graisse  
Dickflüssiges, druckfestes Öl oder Fett  
Thick, pressure-resistant oil or grease

**Moebius 8141 D5**

 Graisse  
Fett  
Grease

**Moebius 9501**

 Ne pas laver  
Nicht waschen  
Do not clean with liquid

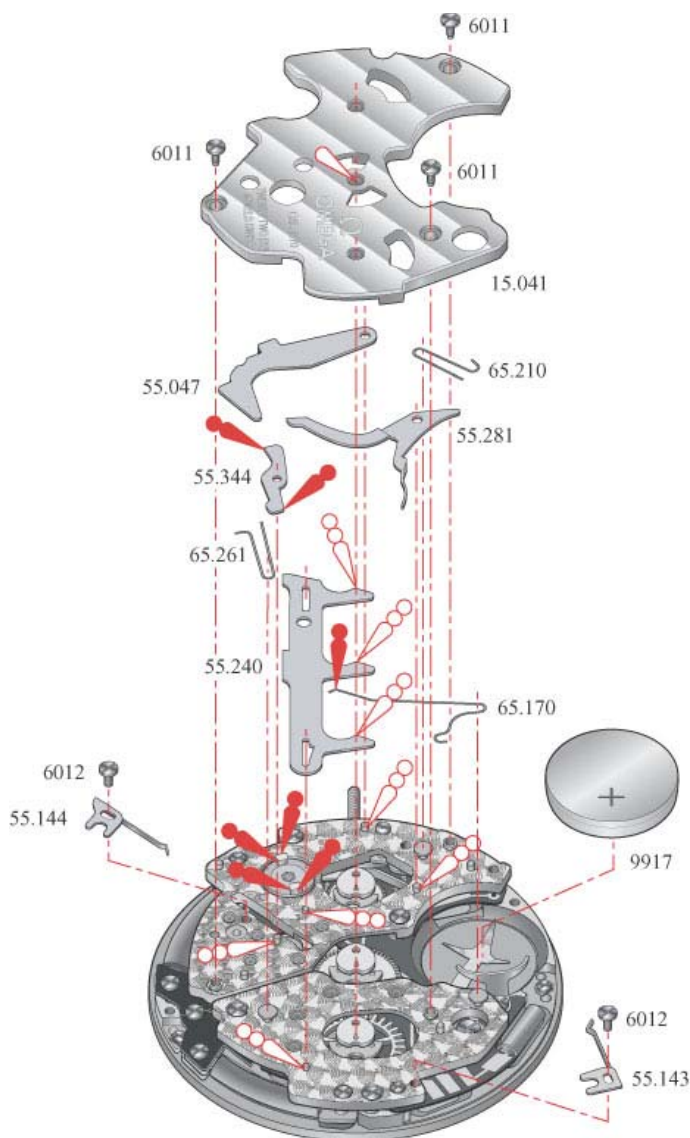

#### Attention

- Positionner les compteurs pour que le marteau appuie contre les coeurs (remise à zéro); la mise en place des ressorts est ainsi facilitée.

#### Achtung

- Die Zähler so positionieren, dass der Herzhebel (55.240) auf den Herzen liegt (Nullstellung). Das Einsetzen der Federn wird dadurch erleichtert.

#### Attention

- Place the counters in such a way that the hammer (55.240) touches the hearts (reset to zero). This simplifies the assembling of the springs.

## Phase 6

**Montage du dispositif quantième**  
(Liste des fournitures par ordre d'assemblage)

**Zusammenbau des Datum-Mechanismus**  
(Bestandteilliste in Montagereihenfolge)

**Assembling of the date mechanism**  
(Parts listed in order of assembly)

50.050	51.052	53.080	6204 4x
6012	31.100	63.030	31.046
31.080	13.102	13.111	61.241
31.041	33.011	6204	
10.212	6012	91.440	
6204 2x	33.020	13.105	

 Huile fine  
Dünnflüssiges Öl  
Fine oil

**Moebius 9010**

 Huile épaisse, à viscosité élevée ou graisse  
Dickflüssiges, druckfestes Öl oder Fett  
Thick, pressure-resistant oil or grease

**Moebius 8141 D5**







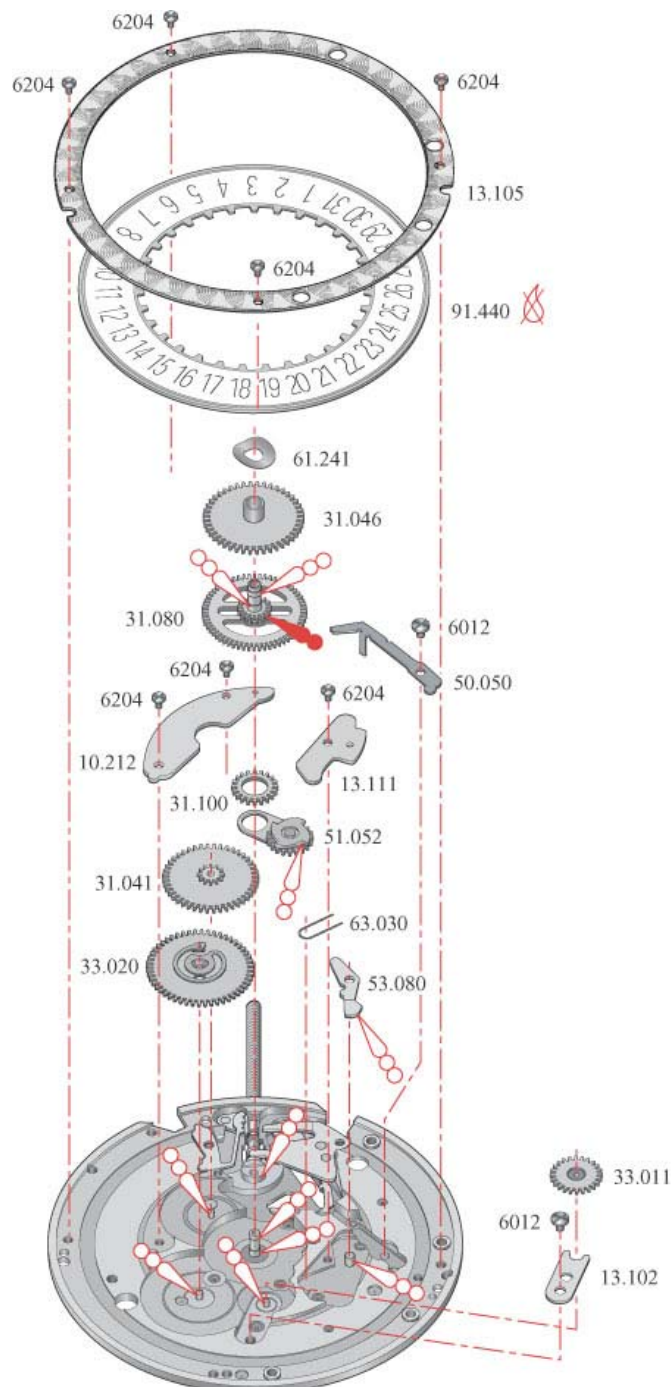





































































 Graisse  
Fett  
Grease

**Moebius 9501**

 Ne pas laver  
Nicht waschen  
Do not clean with liquid



# Listes des fournitures - Ersatzteilliste - Spare parts list

														
10.020	10.048	10.048/1	10.210	10.212	13.102	13.105	13.111							
														
15.040	15.041	20.550	20.580	20.582	20.583	20.587	20.590	20.593						
														
20.651	20.762	31.004	31.006	30.012	30.027	30.029	31.041	31.046	31.080	31.100	31.121	33.011	33.020	35.007
														
35.009	35.010	35.012	35.013	35.030	35.031	35.032	35.033	50.050	51.001	51.010	51.050	51.052	51.080	
														
51.081	51.090	53.080	55.040	55.047	55.130	55.143	55.144	55.240	55.281	55.344	61.100	61.101		
														
61.241	61.530	63.030	65.040	65.170	65.210	65.261	70.200 2x	83.345	91.440	9917 -9,50 x 3,60	9917 -9,50 x 3,60			
														
			762 1x	6007 1x	6011 13x	6012 6x	6021 2x	6204 9x						



## Listes des fournitures - Ersatzteilliste - Spare parts list

Calibre	No CS	Désignation	Beschreibung	Designation
1270	10.020	Platine	Werkplatte	Mainplatte
1270	10.048	Pont de rouage	Räderwerkbrücke	Wheel train bridge
1270	10.048/1	Pont de rouage monté (selon phase 3)	Räderwerkbrücke montiert (gemäss Phase 3)	Wheel train bridge (according to phase 3)
1270	10.210	Couvre-mécanisme	Deckplatte für Stelleinrichtung	Setting mechanism cover
1270	10.212	Couvre-rouage de minuterie	Deckplatte für Wechselrad	Minute train cover
1270	13.102	Plaque de maintien de roue intermédiaire de quantième	Halteplatte für Datum-Zwischenrad	Intermediate date wheel maintaining plate
1270	13.105	Cercle de maintien de l'indicateur de quantième	Haltering für Datumanzeige	Date indicator maintaining ring
1270	13.111	Plaque de maintien du sautoir de quantième	Halteplatte für Datumraste	Date jumper maintaining plate
1270	15.040	Pont de rouage de chronographe	Brücke für Chronograph-Räderwerk	Chronograph wheel train bridge
1270	15.041	Pont de chronographe	Chronograph-Brücke	Chronograph bridge
1270	20.550	Circuit	Schaltung	Circuit
1270	20.580	Rotor mouvement de base	Basiswerk-Rotor	Basic movement rotor
1270	20.582	Stator mouvement de base	Basiswerk-Stator	Basic movement stator
1270	20.583	Stator chronographe	Chronograph-Stator	Chronograph stator
1270	20.587	Rotor chronographe	Chronograph-Rotor	Chronograph rotor
1270	20.590	Bobine chronographe	Chronograph-Spule	Chronograph coil
1270	20.593	Bobine mouvement de base	Basiswerk-Spule	Basic movement coil
1270	20.651	Isolateur de pile	Isolation für Batterie	Battery insulator
1270	20.762	Bride de pile +	Batteriehalterfeder	Battery bridle +
1270	30.012	Roue intermédiaire 1	Zwischenrad 1	Intermediate wheel 1
1270	30.027	Roue de seconde	Sekundenrad	Second wheel
1270	30.029	Roue intermédiaire 2	Zwischenrad 2	Intermediate wheel 2
1270	31.004	Axe du renvoi du compteur d'heures	Welle für Zeigerstellrad für Stundenzähler	Arbor for hour counting setting
1270	31.006	Tenon de commande	Schalthebel-Lagerstif	Operating lever stud
1270	31.041	Roue de minuterie	Wechselrad	Minute wheel
1270	31.046	Roue des heures	Stundenrad	Hour wheel
1270	31.080	Chaussée	Minutenrohr	Cannon pinion
1270	31.100	Renvoi	Zeigerstellrad	Setting wheel
1270	31.121	Pignon coulant	Kupplungstrieb	Sliding pinion
1270	33.011	Roue intermédiaire de quantième	Datum-Zwischenrad	Intermediate date wheel
1270	33.020	Roue entraîneuse de l'indicateur de quantième	Datumanzeiger-Mitnehmerrad	Date indicator driving wheel
1270	35.007	Roue entraîneuse de chronographe 1	Chronograph-Mitnehmerrad 1	Chronograph driving wheel 1
1270	35.009	Roue entraîneuse de chronographe 2	Chronograph-Mitnehmerrad 2	Chronograph driving wheel 2
1270	35.010	Mobile de chronographe	Chronograph-Zentrumrad	Chronograph wheel
1270	35.012	Mobile compteur de minutes	Minutenzählrad	Minute counting wheel
1270	35.013	Roue entraîneuse du compteur de minutes	Mitnehmerrad für Minutenzähler	Driving wheel for minute counting
1270	35.030	Mobile compteur d'heures	Stundenzählrad	Hour counting wheel
1270	35.031	Roue entraîneuse du compteur d'heures	Mitnehmerrad für Minutenzählrad	Hour counting driving wheel
1270	35.032	Renvoi du compteur d'heures	Zeigerstellrad für Stundenzähler	Hour counting setting wheel
1270	35.033	Roue intermédiaire du compteur d'heures	Zwischenrad des Stundenzählers	Intermediate hour counting wheel
1270	50.050	Bloqueur du mouvement	Blockierhebel des Räderwerks	Wheel train lock
1270	51.001	Tube de centre	Zentrallagerrohr	Centre tube
1270	51.010	Tige de mise à l'heure	Stellwelle	Hand-setting stem
1270	51.050	Bascule de pignon coulant	Kupplungstriebhebel	Yoke
1270	51.052	Bascule de renvoi correcteur	Wippe für Datumkorrektions-Verbindungsrad	Date corrector setting wheel rocker
1270	51.080	Tirette	Winkelhebel	Setting lever
1270	51.081	Levier de tirette	Hebel für Winkelhebel	Lever for setting lever
1270	51.090	Sautoir de tirette	Winkelhebelraste	Setting lever jumper

## Listes des fournitures - Ersatzteilliste - Spare parts list

Calibre	No CS	Désignation	Beschreibung	Designation
1270	53.080	Sautoir de quantième	Datmraste	Date jumper
1270	55.040	Commande	Schalthebel	Operating lever
1270	55.047	Commande de marteau	Schalthebel für Herzhebel	Hammer operating lever
1270	55.130	Sautoir de roue à colonnes	Schaltrad-Raste	Column wheel jumper
1270	55.143	Sautoir du compteur de minutes	Minutenzählrad-Raste	Hour counter jumper
1270	55.144	Sautoir du compteur d'heures	Stundenzählrad-Raste	Hour counter jumper
1270	55.240	Marteau	Herzhebel	Hammer
1270	55.281	Bloqueur de chronographe	Blockierhebel für Chronograph	Chronograph lock
1270	55.344	Verrou de marteau	Riegel für Herzhebel	Hammer bolt
1270	61.100	Ressort de bascule	Kupplungshebelfeder	Yoke spring
1270	61.101	Ressort de bascule de renvoi	Wippenfeder	Rocking bar spring
1140	61.241	Ressort de friction de la roue des heures	Friktionsfeder für Stundenrad	Hour wheel friction spring
1270	61.530	Ressort contact d'enclenchement du chronographe	Start-Kontaktfeder für Chronograph	Chronograph starting contact
1270	63.030	Ressort du sautoir de quantième	Feder für Datmraste	Date jumper spring
1270	65.040	Ressort de commande	Schalthebelfeder	Operating lever spring
1270	65.170	Ressort de marteau	Herzhebelfeder	Hammer spring
1270	65.210	Ressort de bloqueur	Blockierhebelfeder	Lock spring
1270	65.261	Ressort du verrou de marteau	Feder für Herzhebelriegel	Hammer bolt spring
1270	70.200	2x Fixateur de cadran	Zifferblatthalter	Dial fastener
1270	83.345	Tenon pour tirette	Winkelhebel-Lagerstift	Setting lever stud
1270	91.440	Indicateur de quantième	Datumanzeiger	Date indicator
1270	762	Vis de limitation de la commande	Begrenzungsschraube für Schalthebel	Banking screw for operating lever
1270	6007	Vis de ressort de commande	Schraube für Schalthebelfeder	Screw for operating lever spring
1270	6011	2x Vis de pont de rouage de chronographe	Schraube für Brücke für Chronograph-Räderwerk	Screw for chronograph wheel train bridge
1270	6011	2x Vis du pont de rouage	Schraube für Räderwerkbrücke	Screw for wheel train bridge
1270	6011	3x Vis de pont de chronographe	Schraube für Chronograph-Brücke	Screw for chronograph bridge
1270	6011	2x Vis du circuit	Schraube für Schaltung	Screw for circuit
1270	6011	2x Vis de bobine	Schraube für Spule	Screw for coil
1270	6011	Vis de circuit de connexion	Schraube für Verbindungsschaltung	Screw for connector circuit
1270	6011	Vis de la bride de pile +	Schraube für Batteriehaltefeder +	Screw for battery bridle +
1270	6012	Vis plaque de maintien de roue intermédiaire de quantième	Schraube für Halteplatte für Datum-Zwischenrad	Screw for intermediate date wheel maintaining plate
1270	6012	Vis du sautoir de tirette	Schraube für Winkelhebelraste	Screw for setting lever jumper
1270	6012	Vis sautoir du compteur de minutes	Schraube für Minutenzählrad-Raste	Screw for minute counter jumper
1270	6012	Vis sautoir du compteur d'heures	Schraube für Stundenzählrad-Raste	Screw for hour counter jumper
1270	6012	Vis du bloqueur du mouvement	Schraube für Blockierhebel des Räderwerks	Screw for wheel train lock
1270	6012	Vis du ressort contact d'enclenchement du chronographe	Schraube für Start-Kontaktfeder für Chronograph	Screw for chronograph starting contact spring
1270	6021	2x Vis de bobine	Schraube für Spule	Screw for coil
1270	6204	Vis du couvre-mécanisme	Schraube für Deckplatte für Stelleinrichtung	Screw for setting mechanism cover
1270	6204	Vis de la plaque de maintien du sautoir de quantième	Schraube für Halteplatte für Datmraste	Screw for date jumper maintaining plate
1270	6204	2x Vis du couvre-rouage de minuterie	Schraube für Deckplatte für Wechselrad	Screw for minute train cover
1270	6204	4x Vis du cercle de maintien de l'indicateur de quantième	Schraube für Haltering für Datum-anzeige	Screw for date indicator maintaining ring
1270	6204	Vis du sautoir de roue à colonnes	Schraube für Schaltrad-Raste	Screw for column wheel jumper
1270	7008	Vis de fixage	Schraube für Werkbefestigung	Screw for case
1270	9917	Pile H. 3,6 mm	Batterie H. 3,66 mm	Battery H. 3,6mm

**Liste des rubis et bouchons**  
**Liste der Rubinen und Zapfenfutter**  
**List of the jewels and bushing**

<b>No.</b>	<b>ø extérieur</b>	<b>ø trou</b>				<b>No. mobile</b>
<b>Nr.</b>	<b>Aussen ø</b>	<b>Loch ø</b>		<b>Position</b>		<b>Rad Nr.</b>
<b>No.</b>	<b>Outside ø</b>	<b>Hole ø</b>				<b>Wheel No.</b>
1270 T221	1.00	0.16	Pont	Brücke	Bridge	20.580
1270 T220	0.70	0.16	Platine	Werkplatte	Mainplate	
1270 T221	1.00	0.16	Pont	Brücke	Bridge	30.012
1270 T220	0.70	0.16	Platine	Werkplatte	Mainplate	
1270 T221	1.00	0.16	Pont	Brücke	Bridge	30.027
1270 T227	0.90	0.22	Platine	Werkplatte	Mainplate	
1270 T221	1.00	0.16	Pont	Brücke	Bridge	30.029
1270 T226	0.60	0.16	Platine	Werkplatte	Mainplate	
1270 T221	1.00	0.16	Pont	Brücke	Bridge	20.587
1270 T220	0.70	0.16	Platine	Werkplatte	Mainplate	
1270 T221	1.00	0.16	Pont	Brücke	Bridge	35.007
1270 T220	0.70	0.16	Platine	Werkplatte	Mainplate	
1270 T221	1.00	0.16	Pont	Brücke	Bridge	35.009
1270 T220	0.70	0.16	Platine	Werkplatte	Mainplate	
1270 T228	1.00	0.25	Pont	Brücke	Bridge	35.010
-	-	-	-	-	-	-
1270 T221	1.00	0.16	Pont	Brücke	Bridge	35.013
1270 T220	0.70	0.16	Platine	Werkplatte	Mainplate	
1270 T228	1.00	0.25	Pont	Brücke	Bridge	35.012
1270 T231	0.90	0.30	Platine	Werkplatte	Mainplate	
1270 T221	1.00	0.16	Pont	Brücke	Bridge	35.033
1270 T220	0.70	0.16	Platine	Werkplatte	Mainplate	
1270 T228	1.00	0.25	Pont	Brücke	Bridge	35.030
1270 75.405	0.70	0.30	Platine	Werkplatte	Mainplate	

1270 T... = Rubis / Rubin / Jewel

1270 75... = Bouchon / Zapfenfutter / Bushing

**Vue côté dessous - Mécanismes de mise à l'heure et de quantième**  
**Ansicht der Unterseite - Stell- und Datummechanismen**  
**View of under side - Hand-setting and data mechanisms**

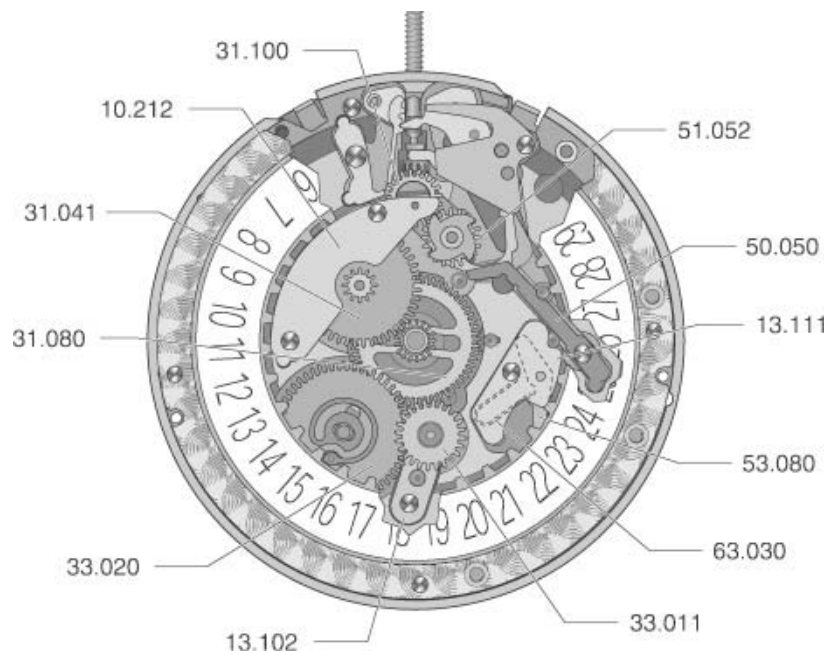
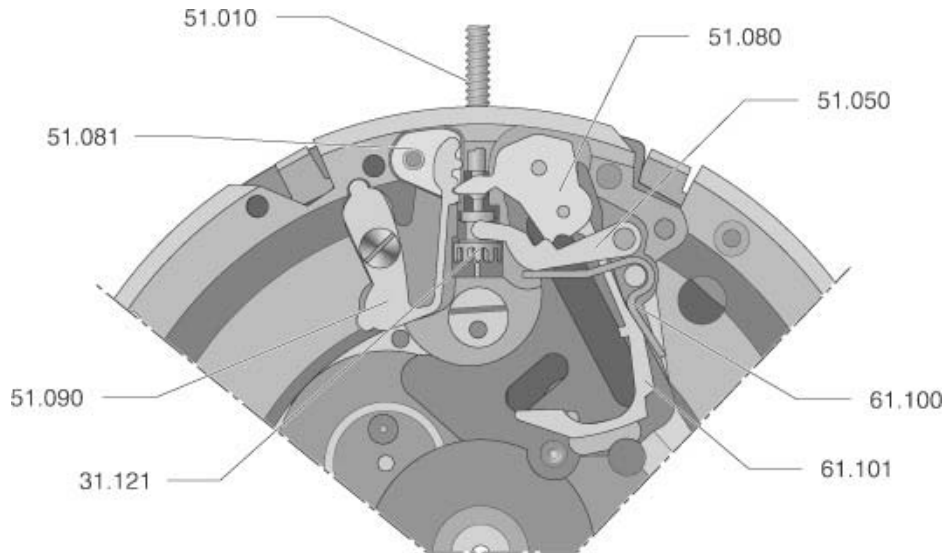

**Vue côté dessous - Rouages du mouvement de base et du chronographe**  
**Ansicht der Oberseite - Räderwerk des Basiswerks und des Chronographs**  
**View of top side - Wheel train of the basic movement and of the chronograph**

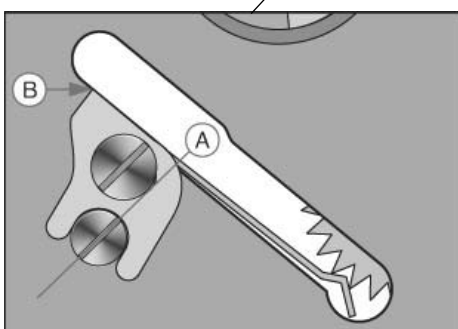
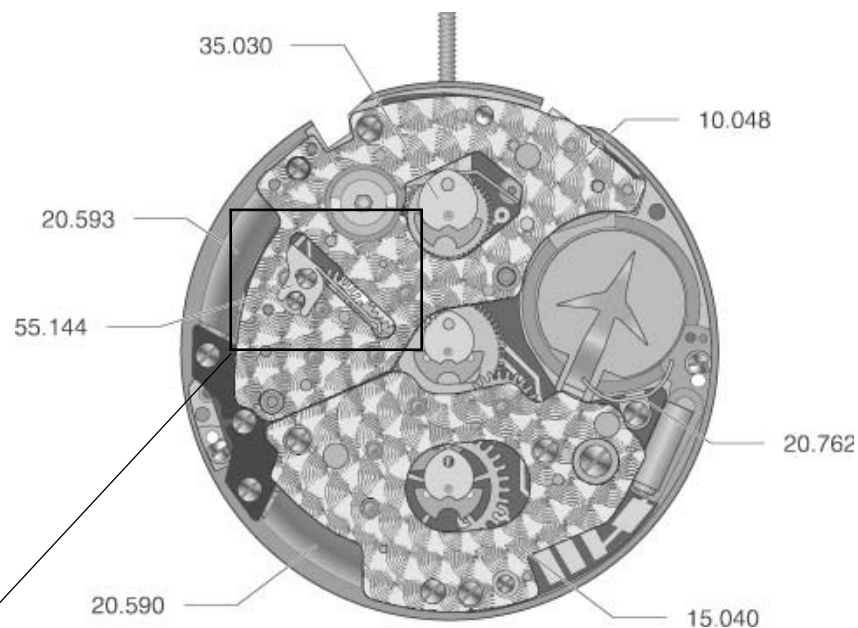
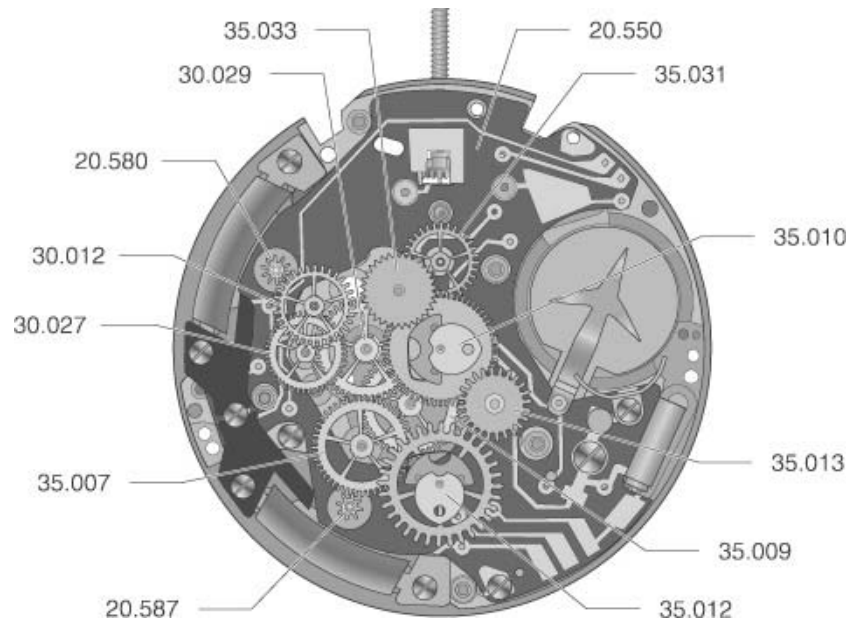

**Contrôle du sautoir compteur d'heures (55.144)**

- Fente de l'excentrique tangente au diamètre de tête de vis (A)
- Sautoir plaqué contre le pont (B)

**Kontrolle der Stundenzählrad-Raste (55.144)**

- Schlitz der Exzentrerschraube mit dem Durchmesser des Schraubenkopfs tangential (A)
- Raste angrenzend an die Brücke (B)

**Checking the hour counter jumper (55.144)**

- Slot of the eccentric screw should be tangential to the screwhead diameter (A)
- Jumper must touch the bridge (B)

## Vue côté dessus - Mécanisme de chronographe

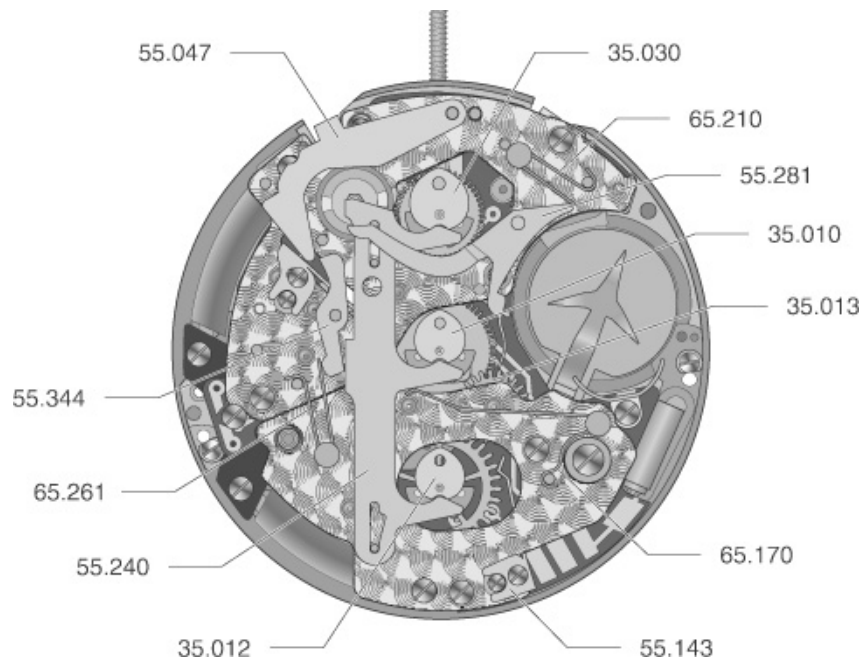

### 1. Réglage du doigt de chronographe Contrôle de la roue intermédiaire du compteur d'heures (35.033)

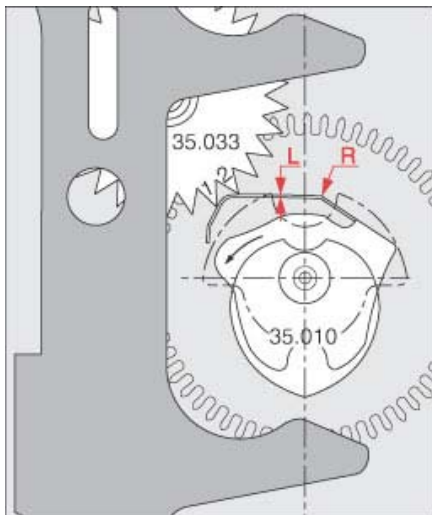

- Mettre en marche le chronographe
- Si nécessaire retoucher le rayon (R) du doigt de chronographe pour faire pénétrer le doigt entre deux dents, sans toucher la dent 2
- Tolérance entre le doigt et la dent 2: fi lame max. (L = 1 lame)

### 2. Contrôle du compteur de minutes (35.012)

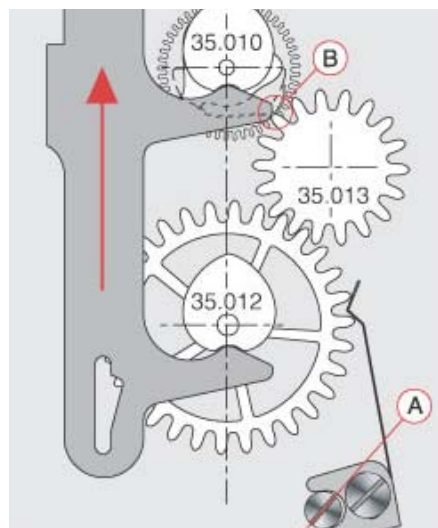

- Remise à zéro du chronographe
- Ne plus toucher le doigt de chronographe
- Fente de l'excentrique tangente au diamètre tête de vis (A)
- Le doigt de chronographe doit se trouver en face de la pointe de dent (B), sans la toucher

### 3. Contrôle de synchronisation

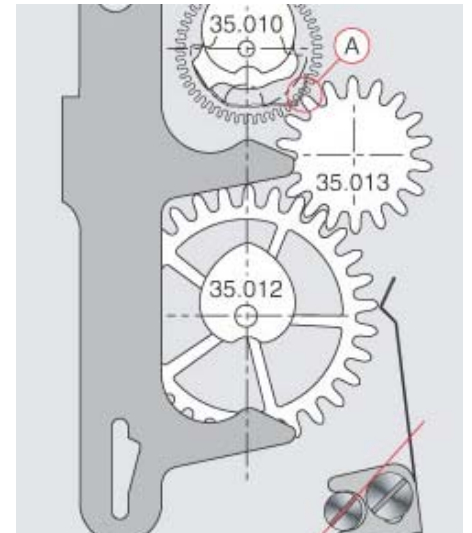

- Mettre le chronographe en marche
- Après 1 minute, lors du passage à 60 secondes le doigt de chronographe (A) fait avancer la roue entraîneuse du compteur de minutes (35.013) d'une dent et provoque ainsi le saut du mobile compteur de minutes (35.012).

## Ansicht von oben - Chronograph-Mechanismus

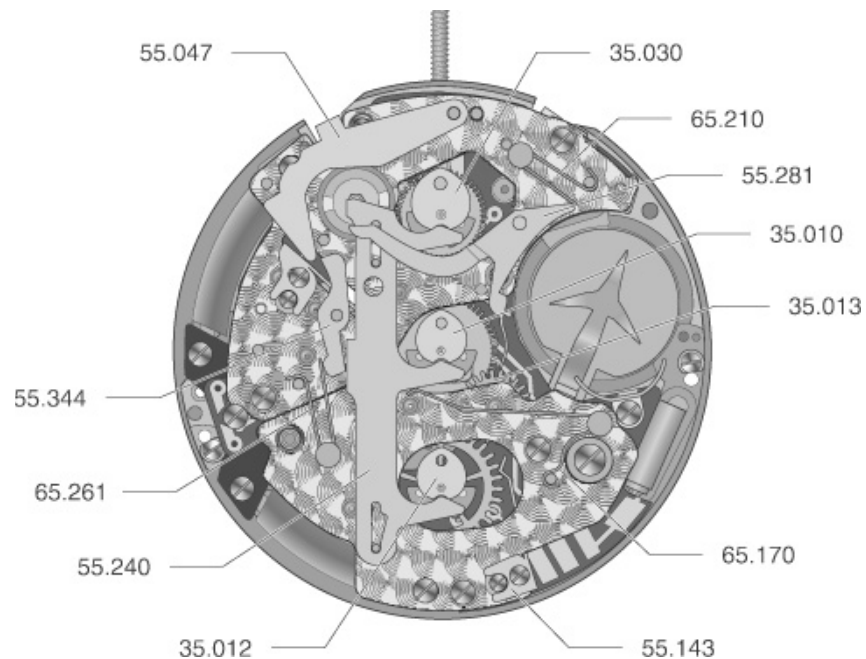

### 1. Regulieren des Chronographfingers Kontrolle des Zwischenrads des Stundenzählers (35.033)

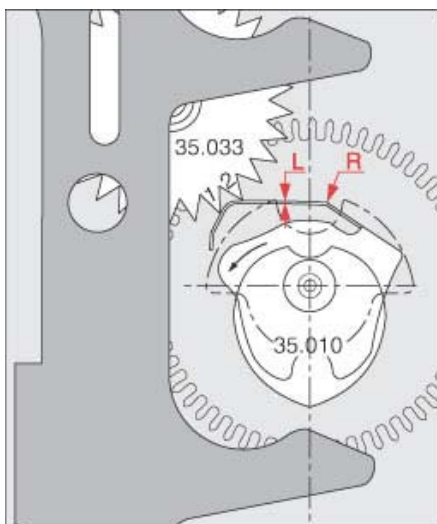

- Den Chronograph in Gang setzen
- Falls nötig den Radius (R) des Chronographfingers korrigieren, so dass der Finger zwischen zwei Zähne eindringt, jedoch ohne den Zahn 2 zu berühren
- Toleranz zwischen Finger und Zahn 2: Maximum fi Klinge (L = 1 Klinge)

### 2. Kontrolle des Minutenzählers (35.012)

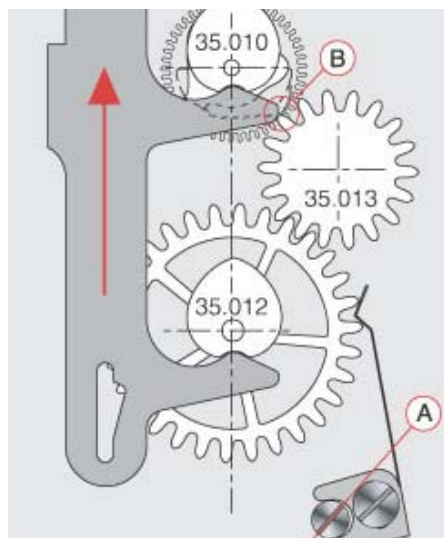

- Nullstellung des Chronographs
- Den Chronographfinger nicht mehr berühren
- Schlitz der Exzenterschraube mit dem Durchmesser des Schraubenkopfs tangential (A)
- Der Chronographfinger muss sich gegenüber der Zahnschnecke (B) befinden, darf sie jedoch nicht berühren

### 3. Kontrolle der Synchronisation

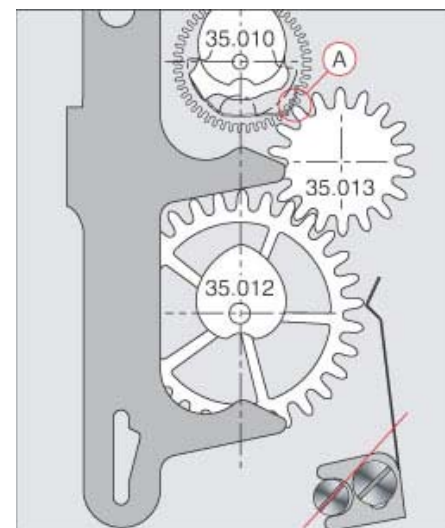

- Den Chronograph in Gang setzen
- Nach einer Minute, beim Passieren der 60 Sekunden, bewegt der Chronographfinger das Mitnehmerrad für Minutenzählrad (35.013) um **einen Zahn (A)** vorwärts und erzeugt somit den Sprung des Minutenzählrads (35.012).

## View of top side - Chronograph mechanism

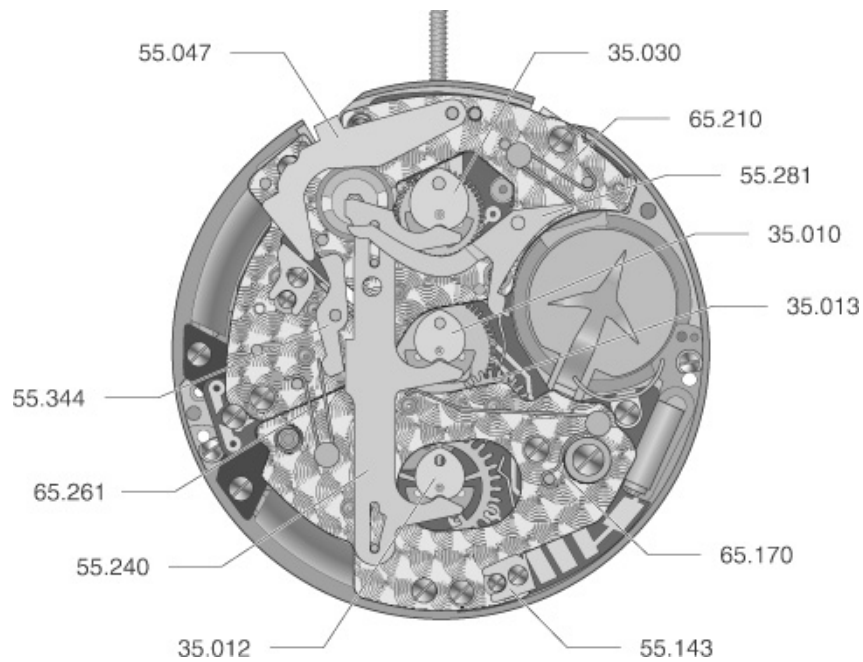

### 1. Adjusting the chronograph finger Checking the intermediate hour counting wheel (35.033)

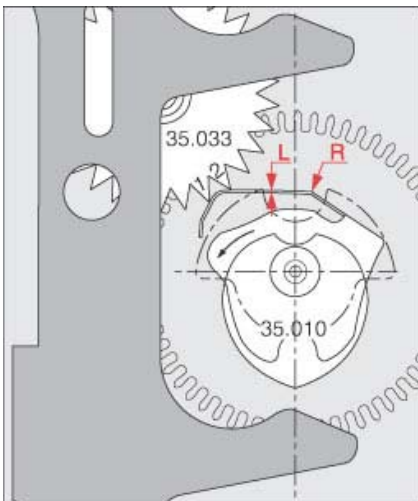

- Start the chronograph
- If necessary adjust the radius (R) of the chronograph finger in order to make the finger penetrate between two teeth without touching the tooth 2
- Tolerance: fi blade maximum (L = 1 blade)

### 2. Checking the minute counting wheel (35.012)

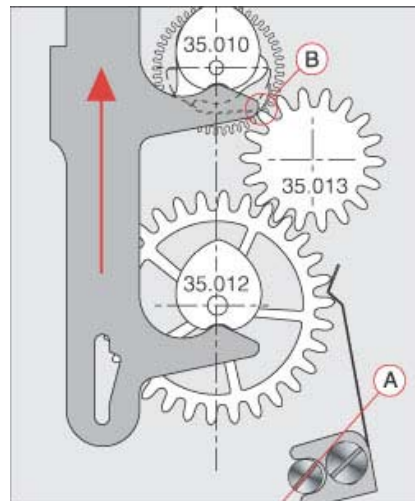

- Reset the chronograph to zero
- Do not touch the chronograph finger anymore
- Slot of the eccentric screw should be tangent to the screwhead diameter (A)
- The chronograph finger must be opposite the teeth point (B) without touching it

### 3. Checking the synchronisation

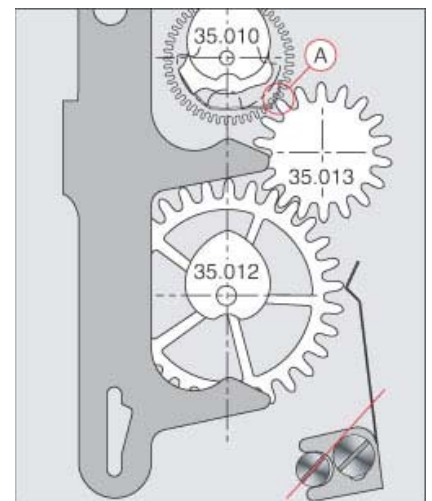

- Start the chronograph
- After one minute, when passing at 60 seconds, the chronograph finger moves the driving wheel for minute counting wheel (35.013) **one tooth** forward and makes the minute counting wheel jump.



## Aiguillage – Zeigerwerkhöhe – Hand fitting height

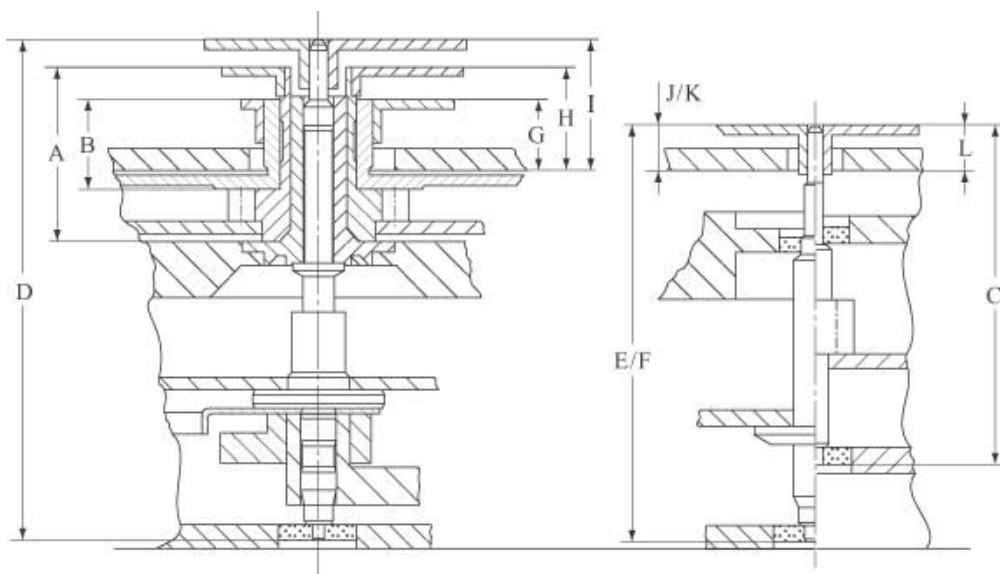

<b>Longueur - Länge - Lenght</b>						
Aiguillage Zeiger- werkhöhe Hand fitting height	Chaussée Minuten- rohr Cannon pinion	Roue des heures Stundenrad Hour wheel	Petite seconde Kleine Sekunde Small second	Seconde chrono Chrono Sekunde Chrono second	Heures chrono Chrono Stunden Chrono hours	Minutes chrono Chrono Minuten chrono minutes
	A	B	C	D	E	F
1*	2.10	1.10	4.22	6.27	5.27	5.27
2	2.40	1.40	4.52	6.57	5.57	5.57
3	2.60	1.60	4.72	6.77	5.77	5.77
4	2.85	1.85	4.97	7.02	6.02	6.02
5	3.80	2.80	5.92	7.97	6.97	6.97

<b>Dépassement platine - Höhe über Zifferblattaufgabe - Height over dial seat</b>						
Aiguillage Zeiger- werkhöhe Hand fitting height	Roue des heures Stundenrad Hour wheel	Chaussée Minuten- rohr Cannon pinion	Seconde chrono Chrono Sekunde Chrono second	Heures chrono Chrono Stunden Chrono hours	Minutes chrono Chrono Minuten chrono minutes	Petite seconde Kleine Sekunde Small second
	G	H	I	J	K	L
1*	0.90	1.25	1.60	0.60	0.60	0.60
2	1.20	1.55	1.90	0.90	0.90	0.90
3	1.40	1.75	2.10	1.10	1.10	1.10
4	1.65	2.00	2.35	1.35	1.35	1.35
5	2.60	2.95	3.30	2.10	2.10	2.10

\* Omega

- L'aiguille se fait à l'aide du posage aiguilles (réf. 502 120 0241). Veiller au bon réglage des appuis des 4 mobiles. En aucun cas chasser les aiguilles sans appui.
- Das Setzen der Zeiger erfolgt mit Hilfe eines Werkhalters (Ref. 502 120 0241). Darauf achten, dass die 4 Räder gut aufgestützt sind. Auf keinen Falls die Zeiger ohne Auflage setzen.
- Use the movement holder (ref. 502 120 0241) for fitting the hands. Be careful to provide good support for the 4 wheels. Never fit the hands without support.

# Contrôles életriques Elektrische Kontrollen Eletrical tests

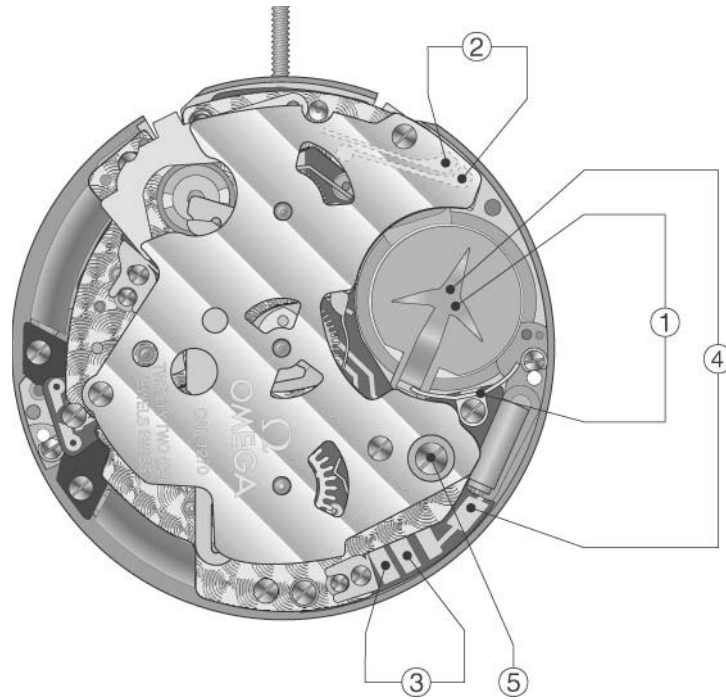

Position Messpunkt Position	Echelle de mesure Einstellung Messgerät Setting of apparatus	Mesure Messung Measurement	Contrôle Kontrolle Test	Remarques Bemerkungen Remarks
-	2 V (Ri ø 10 KΩ / V)	1.55 V	Tension de la pile  Spannung der Batterie  Battery voltage	Contrôler la pile en dehors du mouvement (mesure avec la pile en place pas possible)  Die Batterie muss ausserhalb des Werks kontrolliert werden (Kontrolle mit eingesetzter Batterie nicht möglich)  The battery has to be tested outside of the move- ment (test with assembled battery not possible)
1*	1.55 V	< 1.20 µA	Consommation du mouvement  Stromaufnahme Uhrwerk  Consumption of movement	Mesure sans pile, avec alimentation extérieure de 1.55 V, Tige en position 1 (neutre), Chronographe sur remise à zéro Messung ohne Batterie, mit Speisung von aussen 1.55 V, Stellwelle in Position 1 (neutral), Chrono- graph auf Nullstellung Measurement without battery, with external power supply 1.55 V, hand-setting stem in position 1 (neutral), chronograph reset to zero
	1.55 V	< 0.45 µA	Consommation du module électronique  Stromaufnahme des elektronischen Moduls  Consumptio of elec- tronic module	Mesure sans pile avec alimentatin extérieure de 1.55 V, Tige en position 3 Messung ohne Batterie, mit Speisung von aussen 1.55 V, Stellwelle in Position 3 Measurement without battery, with external power supply 1.55 V, hand-setting stem in position 3

Position Messpunkt Position	Echelle de mesure Einstellung Messgerät Setting of apparatus	Mesure Messung Measurement	Contrôle Kontrolle Test	Remarques Bemerkungen Remarks
<b>1*</b>	1.55 V	< 23.00 $\mu$ A	Consommation du mouvement et du chronographe Stromaufnahme Werk und Chronograph Consumption movement and chronograph	Mesure sans pile avec alimentation extérieure de 1.55 V, Tige en position 1 Chronographe en marche Messung ohne Batterie, mit Speisung von aussen 1.55 V, Stellwelle in Position 1 Chronograph laufend Measurement without battery with external power supply 1.55 V, hand-setting stem in position 1, chronograph running
<b>2</b>	10 K $\Omega$	3.25 - 3.55 K $\Omega$	Continuité bobinage mouvement de base Zustand der Spule des Basiswerks Condition of basic movement coil	Mesure sans pils avec tension d'alimentation 0.2 V Ohmmètres avec tension de mesure supérieure à 0.5 V inappropriés Tension recommandée 0.2 V Température ambiante 20° C Messung ohne Batterie, mit Speisespannung 0.2 V Ohmmeter mit Prüfspannung über 0.5 V ungeeignet Empfohlene Spannung 0.2 V Raumtemperatur 20° C Measurement without battery, voltage supply 0.2 V Ohmmeter with a test voltage higher than 0.5 V unsuitable Recommended voltage 0.2 V Ambient temperature 20° C
<b>3</b>	10 K $\Omega$	3.25 - 3.55 K $\Omega$	Continuité bobinage du chronographe Zustand der Spule des Chronographs Condition of chronograph coils	Mesure sans pile avec alimentatin extérieure de 1.55 V, Chronographe sur remise à zéro Messung ohne Batterie, mit Speisung von aussen 1.55 V, Chronograph auf Nullstellung Measurement without battery, with external power supply 1.55 V, Chronograph reset to zero
<b>4</b>	1.55 V	< 1.25 V	Limite inférieure de la tension de fonctionnement du chronographe Untere Funktionsspannungsgrenze des Chronographs Lower working voltage of chronograph	Mesure sans pile avec alimentation extérieure de 1.55 V Chronographe en marche Messung ohne Batterie, mit Speisung von aussen 1.55 V Chronograph laufend Measurement without battery, with external power supply 1.55 V Chronograph running
<b>5</b>	32'768 Hz	-3/+6 s/M	Précision de marche Ganggenauigkeit Precision of the rate	Réglage par trimmer Regulierung durch Trimmer Adjustment by trimmer

\* Court-circuiter le mouvement avant le contrôle  
Das Werk vor dem Messen kurzschliessen  
Short circuit the movement before measuring