

Specification

11 ½"

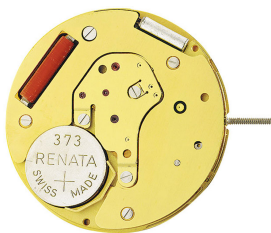

Dimensions and battery

∅ Total	26.2 mm
∅ Case fitting	25.6 mm
Movement height	3.30 mm
Movement rest	1.40 mm
Height of stem	1.80 mm
Stem: Thread / Distance	0.90 mm / 0.90 mm
Battery / Autonomy	Nr. 373 / 36 Months

Performances

	Second hand: 6 µNm
Torque T	Minute hand: 300 µNm
Operating temperature	0°C - 50°C
Res. against magn. fields	18.8 Oe = 1500 A/m
Resistance against shock	NIHS 91 - 10

Functions

Position I (crown)	Neutral
Position II (crown)	Setting the date (quick mode)
Position III (crown)	Setting Time

Assembling

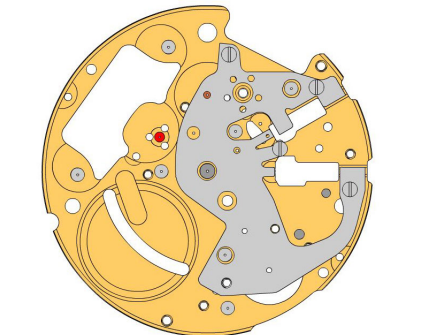

A

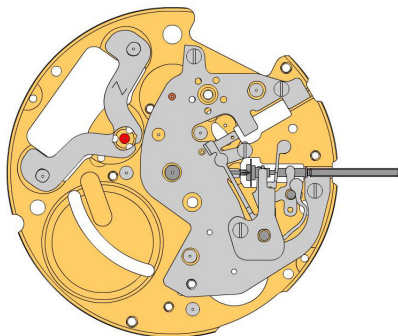

B

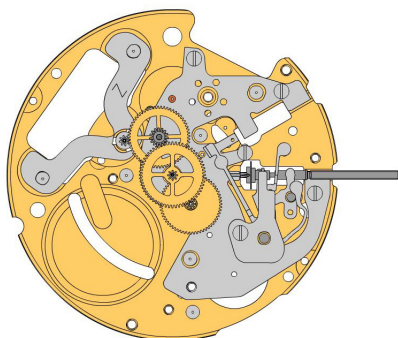

C

1. 2000.626.G **Main plate**
2. 2130.167 **Centre bridge**
Use 4 screws 4000.300 to fix the center bridge.
3. 4000.300 **Screw**
4. 3017.052 **Setting lever**
The cam on the setting lever must be inserted into the cut out on the stem. (the setting lever must be greaced)
5. 3015.074 **Yoke (3 positions)**
The yoke must be inserted below, into the cut out of the sliding pinion.
6. 3001.042 **Sliding pinion**
The sliding pinion must be holded using a tweezers, untill the stem is inserted.
7. 3000.189.CO **Handsetting stem**
Prior to the insertion of the stem, some greace must be placed on the square part of the stem.
8. 2020.166 **Yoke bridge**
Use 1 screw 4000.244.
9. 4000.244 **Screw**
10. 3622.042 **Stator**
11. 3715.103.RK **Rotor centre**
* Use an antimagnetic tweezers to place the rotor.
12. 3147.056.CO **Intermediate wheel**
13. 3122.059.CO **Third wheel**
14. 3136.160.CO **Second wheel (height 1)**

Assembling

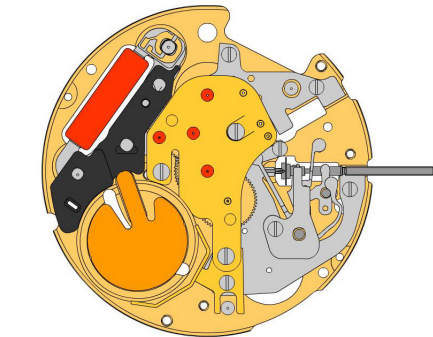

D

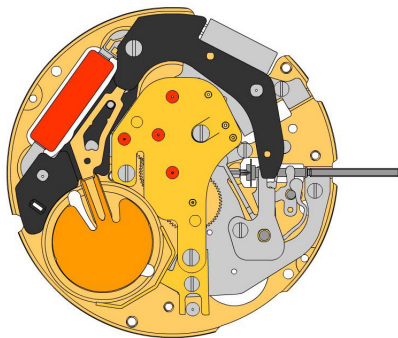



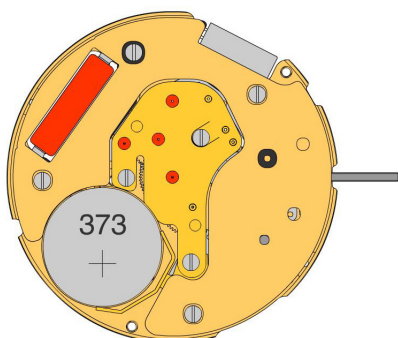

E







F



15. **2020.167.G** **Train wheel bridge**



Attention: Prior to the fastening process of the bridge, all pins of the wheels must be visible in the holes in the bridge. Use 3 screws 4000.279.
16. **4000.279** **Screw**

17. **3601.117** **Battery contact spring**

Use 1 screw 4000.244.
18. **4000.244** **Screw**

19. **3621.060.RK** **Coil (movment)**

The wire of the coil (red area) is very sensitiv to mechanical impacts. Hold the coil only outside the red area. Fix the coil by 1screw 4000.250.
20. **3603.074** **Bride insulator**

21. **3603.075** **Battery insulator**

22. **3601.116** **Bridle (-)**

Make shure, that the pusher contact spring is placed correctly onto the pillars.
23. **3612.181.6003** **Electronic module**





After assembly of the electronic module it is the best time to perform the electrical measurements. Use 1 screw 4000.318 to fix the electronic module.
24. **4000.318** **Screw**

25. **2130.168.6003.B** **Electronic module cover (counter 6h)**

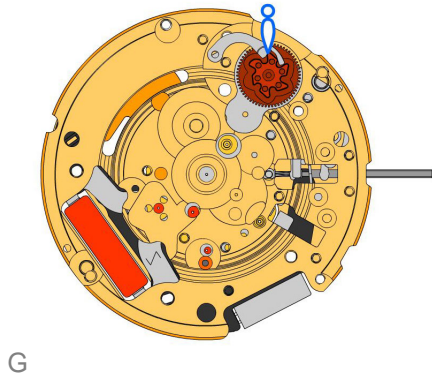
Use 3 screws 4000.102 to fix the electronic module cover
26. **4000.102** **Screw**

27. **3600.031** **Battery**





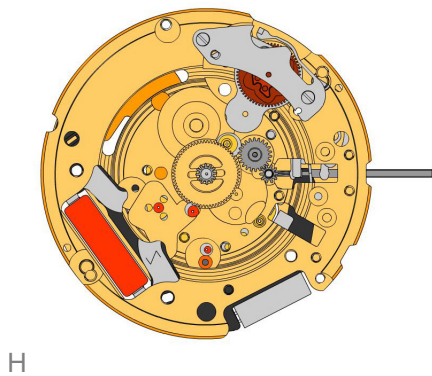

Use a plastic tweezers to place the battery (to avoid short circuit of battery).

Assembling





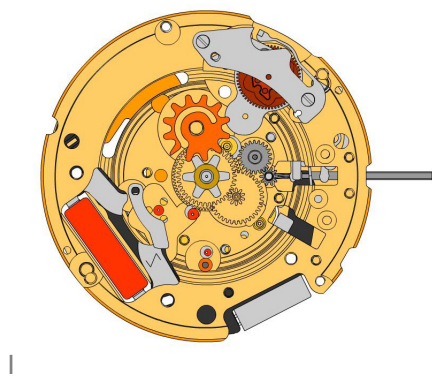

- 28. 2000.626.Gb **Main plate**

- 29. 9014.000 **Moebius 9014**
Use Moebius 9014 on bearing of all rubis

- 30. 3004.188 **Tens indicator driving wheel**
The short tooth of the tens indicator driving wheel must point to the center of the movement.

- 31. 3500.060 **Tens jumper**
Moebius 8200 greace must be placed between the tens jumper and the tens indicator driving wheel.



- 32. 2130.171 **Tens jumper maintaining plate**
Make shure, that the tens indicator driving wheel is not blocked prior to the fastening process. Use 2 screws 4010.306. Place the spring loaded bracket outside of the tens jumper.

- 33. 4010.306 **Screw**

- 34. 3004.182 **Setting wheel**
Use Moebius 9020

- 35. 3004.183 **Setting wheel inter.**

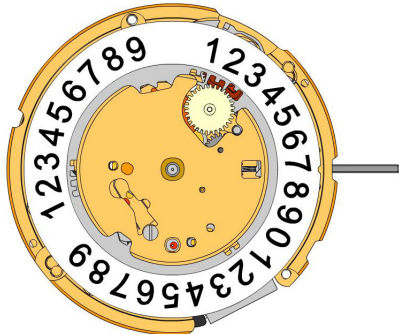
- 36. 3305.305.CO **Date indicator driving wheel**
Moebius 9020 must be used in the center of this wheel



- 37. 3007.073

- 38. 3301.271.CO **Hour wheel (Aig 1)**

- 39. 3315.001 **Hour wheel friction spring**

- 40. 3004.187 **Date indicator driving wheel**
Moebius 9020 must be used in the center of this wheel.

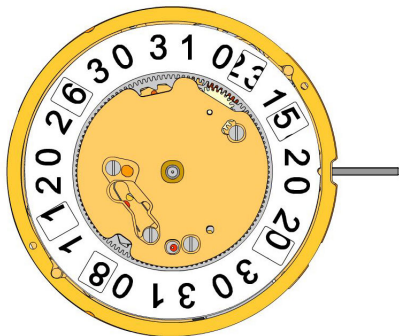
- 41. 3500.061 **Date jumper**
Moebius 8200 greace must be placed between the date jumper and the date jumper spring













Assembling



J



K

- 42. 3504.217 **Units indicator**

 Teeth must be greaced using Moebius 8200. The "half moon" cut out on the unit indicator must point to the stem (position 3h).
- 43. 3147.057 **Tens intermediate wheel**

- 44. 2130.169 **Date indicator maintaining plate**

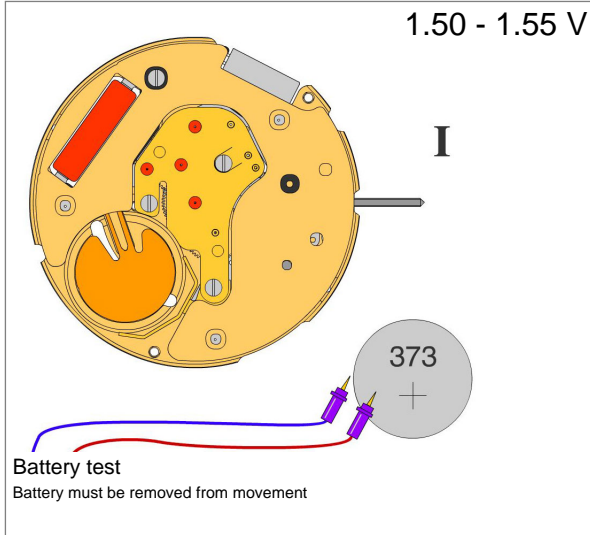
 use 1 screw 4000.312
- 45. 3905.050 **Date jumper spring**

 Insert the spring into the opening of the date indicator maintaining plate
- 46. 3504.218 **Tens indicator (T3/G12)**

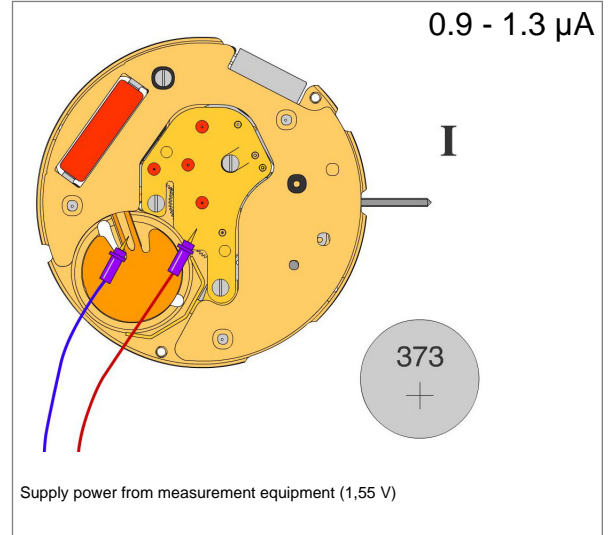
 The "half moon" cut out on the tens indicator must point to the stem (position 3h).
- 47. 2130.170 **Date mechanism maintaining plate**

 Assure that the tens intermediate wheel is not blocked, prior to the fastening process. Use 3 screws 4000.312 to fix the date indicator maintaining plate.
- 48. 4000.312 **Screw**

- 49. 3506.075.G **Dial support**

- 50. 9010.000 **Moebius 8200**

 Microgliss D5 can be used
- 51. 9018.000 **Jismaa 124**

 Greace Moebius or Microgliss D5 an be used
- 52. 9020.000 **Moebius 9020**

Electrical checking

Voltage of battery



Consumption of movem. (Pos. I)



Consumption of movem. (Pos. III)

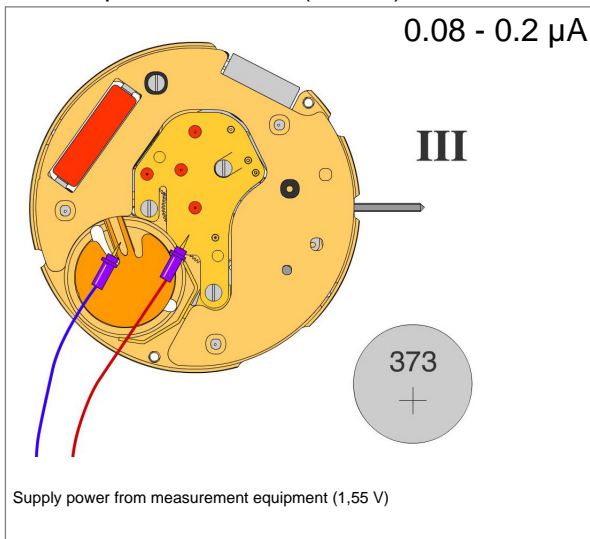

Lowest voltage for movement

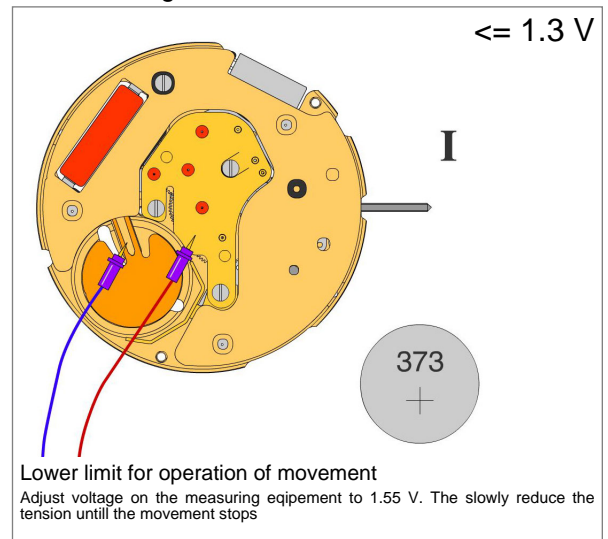

Accuracy (seconds / month)

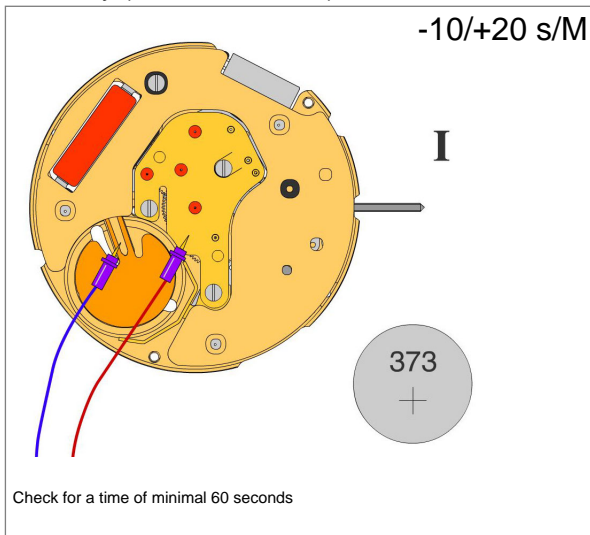

Resistance of the coil

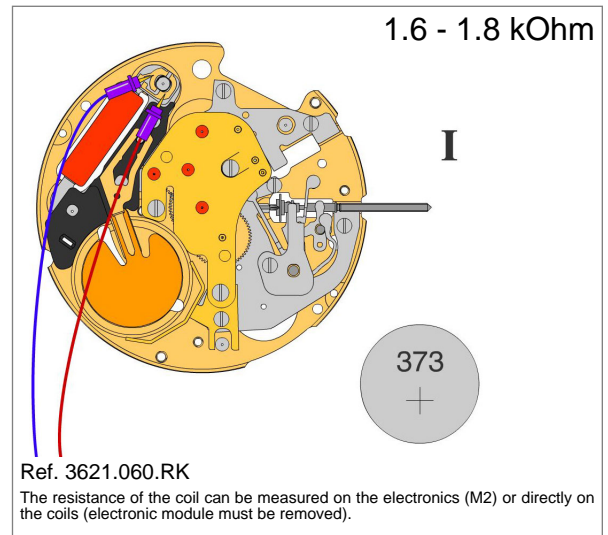

Electrical checking

Coil insulation

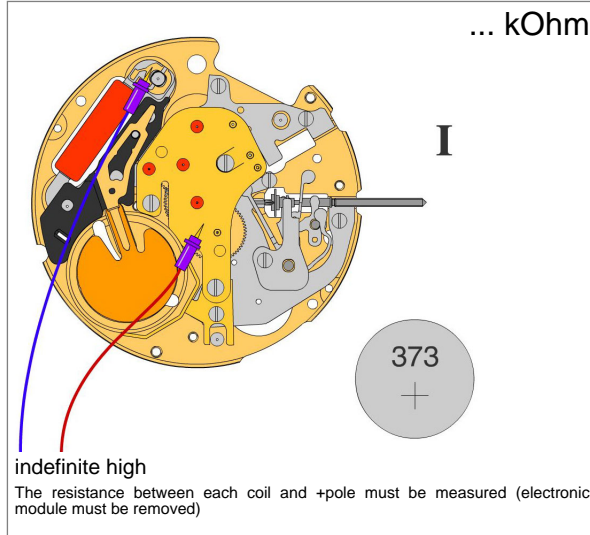

Accelerated test of movement

