

### Specification

11 ½"

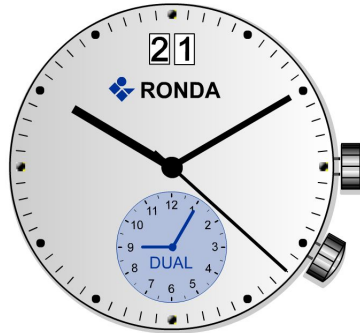

#### Dimensions and battery

∅ Total	26.2 mm
∅ Case fitting	25.6 mm
Movement height	3.30 mm
Movement rest	1.40 mm
Height of stem	1.80 mm
Stem: Thread / Distance	0.90 mm / 0.90 mm
Battery / Autonomy	Nr. 373 / 36 Months

#### Performances

	Second hand: 6 µNm
Torque T	Minute hand: 300 µNm
Operating temperature	0°C - 50°C
Res. against magn. fields	18.8 Oe = 1500 A/m
Resistance against shock	NIHS 91 - 10

#### Functions

Position I (crown)	Neutral
Position II (crown)	Setting the date (quick mode)
Position III (crown)	Setting Time
Position I (crown 2)	Neutral
Position II (crown 2)	Set 2nd time

### Assembling

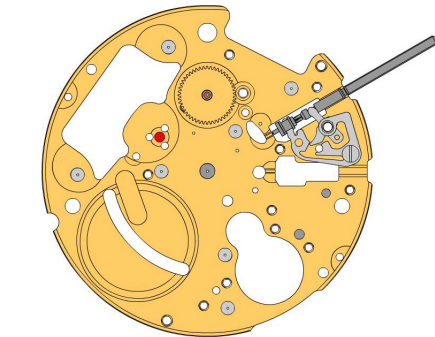



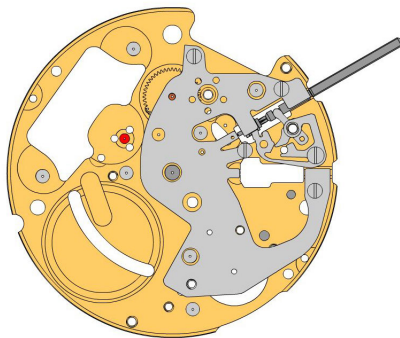



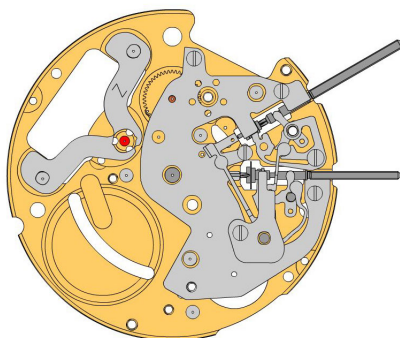









A



B



C

1. 2000.625.G **Main plate**  

2. 3017.052 **Setting lever**  
  
 The cam on the setting lever must be inserted into the cut out on the stem. (the setting lever must be greaced)
3. 3015.075 **Yoke dual**  
  
 Use 1 screw 4000.282
4. 4000.282 **Screw**  

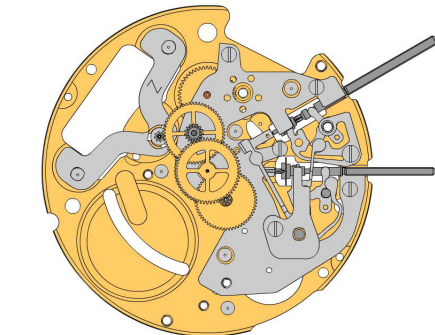
5. 3001.044 **Sliding pinion**  
  
 The sliding pinion must be holded using a tweezers, untill the stem is inserted.
6. 3000.190.CO **Handsetting stem**  
  
 Prior to the insertion of the stem, some greace must be placed on the square part of the stem.
7. 3301.277 **Hour wheel dual BD**  

8. 2130.167 **Centre bridge**  
  
 Use 4 screws 4000.300 to fix the center bridge.
9. 4000.300 **Screw**  

10. 3017.052 **Setting lever**  
  
 The cam on the setting lever must be inserted into the cut out on the stem. (the setting lever must be greaced)
11. 3015.074 **Yoke (3 positions)**  
  
 The yoke must be inserted below, into the cut out of the sliding pinion.
12. 3001.042 **Sliding pinion**  
  
 The sliding ponion must be holded using a tweezers, untill the stem is inserted.
13. 3000.189.CO **Handsetting stem**  
  
 Prior to the insertion of the stem, some greace must be placed on the square part of the stem.
14. 2020.166 **Yoke bridge**  
  
 Use 1 screw 4000.244.
15. 4000.244 **Screw**  

16. 3622.042 **Stator**  

### Assembling



D

17. **3715.103.RK** Rotor centre  
 \*  Use an antimagnetic tweezers to place the rotor.

18. **3147.056.CO** Intermediate wheel  
 →

19. **3122.059.CO** Third wheel  
 →

20. **3136.160.CO** Second wheel (height 1)  
 ↓

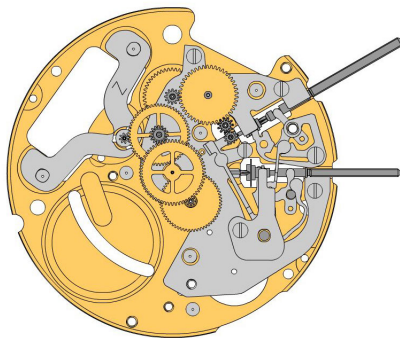

E

21. **3305.313** Pignon chausée dual  
 \*  ↑

22. **3004.185.CO** Setting wheel inter. dual  
 \* 

23. **3004.198.FI** Setting wheel dual  
 \* 

24. **3007.074.CO** Minute wheel dual  
 →

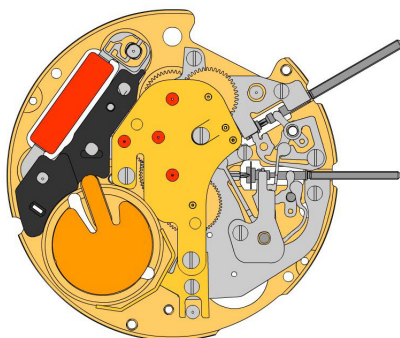

F

25. **2020.167.G** Train wheel bridge  
 Attention: Prior to the fastening process of the bridge, all pins of the wheels must be visible in the holes in the bridge. Use 3 screws 4000.279.

26. **4000.279** Screw  

27. **3601.117** Battery contact spring  
 Use 1 screw 4000.244.

28. **4000.244** Screw  

29. **3621.060.RK** Coil (movment)  
 The wire of the coil (red area) is very sensitiv to mechanical impacts. Hold the coil only outside the red area. Fix the coil by 1screw 4000.250.

30. **3603.074** Bride insulator  

31. **3603.075** Battery insulator  

### Assembling

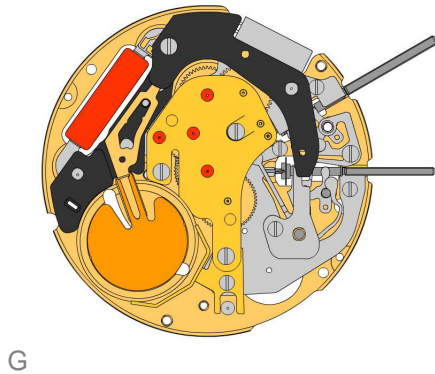

32. **3601.116** **Bridle (-)**  
 Make shure, that the pusher contact spring is placed correctly onto the pillars.

33. **3612.181.6203** **Electronic module**  
 After assembly of the electronic module it is the best time to perform the electrical measurements. Use 1 screw 4000.318 to fix the electronic module.

34. **4000.318** **Screw**



35. **2130.168.6203.B** **Electronic module cover (counter 6h)**  
 Use 3 screws 4000.102 to fix the electronic module cover

36. **4000.102** **Screw**



37. **3600.031** **Battery**  
 Use a plastic tweezers to place the battery (to avoid short circuit of battery).

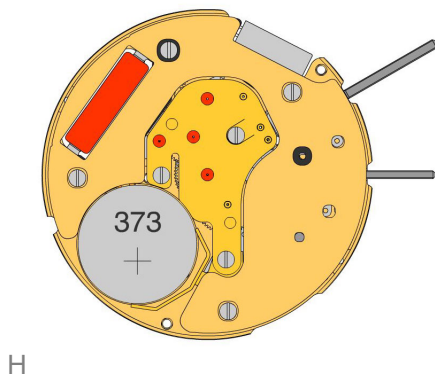

### Assembling

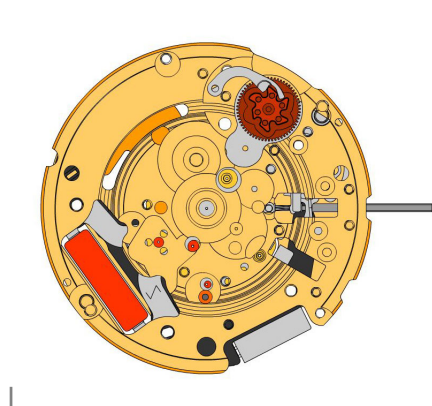

38. 2000.625.Gb Main plate



39. 9014.000 Moebius 9014  
 Use Moebius 9014 on bearing of all rubis



40. 3004.188 Tens indicator driving wheel  
 The short tooth of the tens indicator driving wheel must point to the center of the movement.



41. 3500.060 Tens jumper  
 Moebius 8200 grease must be placed between the tens jumper and the tens indicator driving wheel.



42. 2130.171 Tens jumper maintaining plate  
 Make shure, that the tens indicator driving wheel is not blocked prior to the fastening process. Use 2 screws 4010.306. Place the spring loaded bracket outside of the tens jumper.



43. 4010.306 Screw



44. 3004.182 Setting wheel  
 Use Moebius 9020



45. 3004.183 Setting wheel inter.



46. 3305.305.CO Date indicator driving wheel  
 Moebius 9020 must be used in the center of this wheel

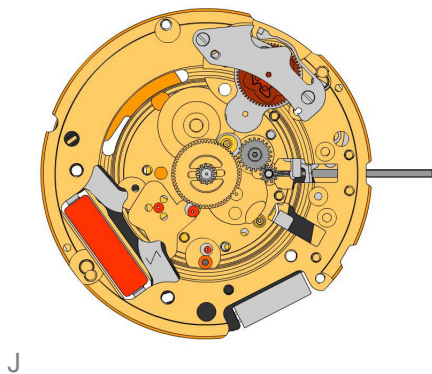

47. 3007.073



48. 3301.271.CO Hour wheel (Aig 1)



49. 3315.001 Hour wheel friction spring



50. 3004.187 Date indicator driving wheel  
 Moebius 9020 must be used in the center of this wheel.



51. 3500.061 Date jumper  
 Moebius 8200 grease must be placed between the date jumper and the date jumper spring

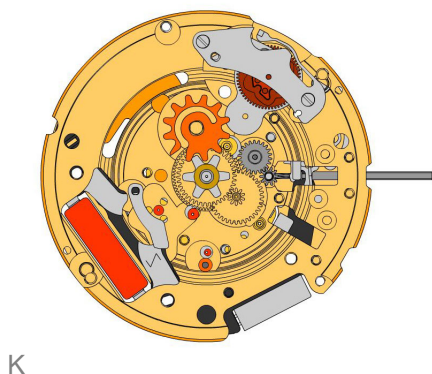



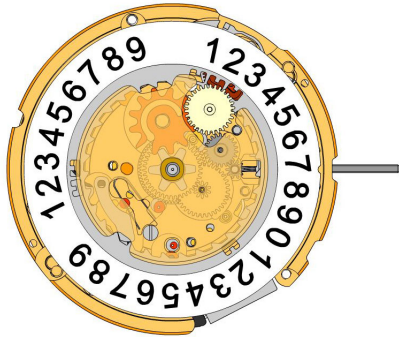



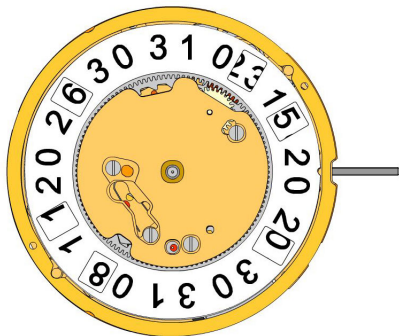





### Assembling



L



M

- 52. 3504.217 **Units indicator**  

 Teeth must be greaced using Moebius 8200. The "half moon" cut out on the unit indicator must point to the stem (position 3h).
- 53. 3147.057 **Tens intermediate wheel**  

- 54. 2130.169 **Date indicator maintaining plate**  

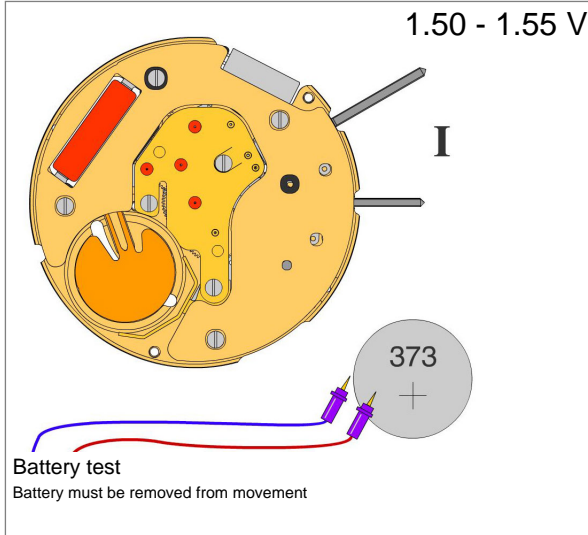
 use 1 screw 4000.312
- 55. 3905.050 **Date jumper spring**  

 Insert the spring into the opening of the date indicator maintaining plate
- 56. 3504.218 **Tens indicator (T3/G12)**  

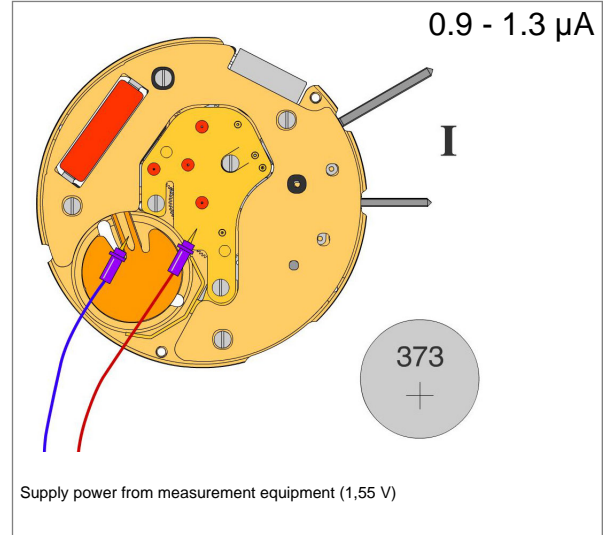
 The "half moon" cut out on the tens indicator must point to the stem (position 3h).
- 57. 2130.170 **Date mechanism maintaining plate**  

 Assure that the tens intermediate wheel is not blocked, prior to the fastening process. Use 3 screws 4000.312 to fix the date indicator maintaining plate.
- 58. 4000.312 **Screw**  

- 59. 3506.075.G **Dial support**  

- 60. 9010.000 **Moebius 8200**  
 Microgliss D5 can be used  

- 61. 9018.000 **Jismaa 124**  
 Greace Moebius or Microgliss D5 an be used  

- 62. 9020.000 **Moebius 9020**  

### Electrical checking

#### Voltage of battery



#### Consumption of movem. (Pos. I)



#### Consumption of movem. (Pos. III)

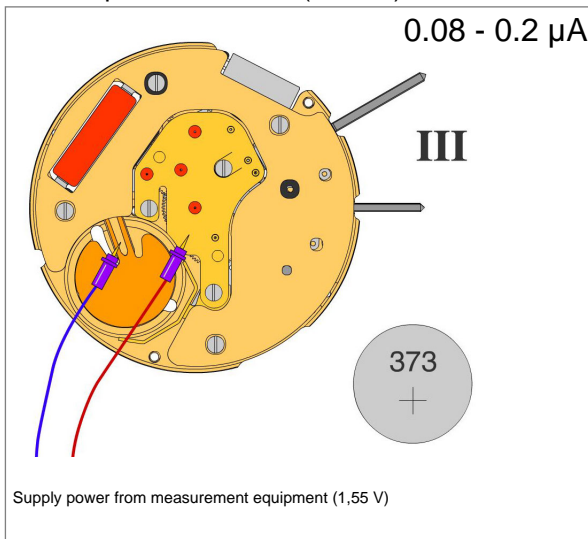

#### Lowest voltage for movement

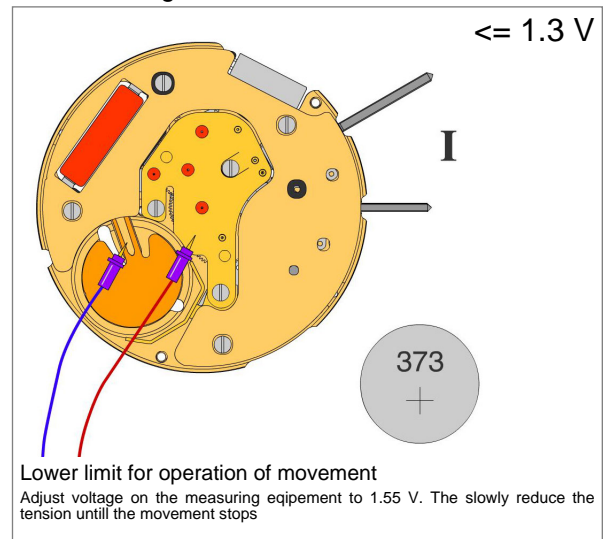

#### Accuracy (seconds / month)

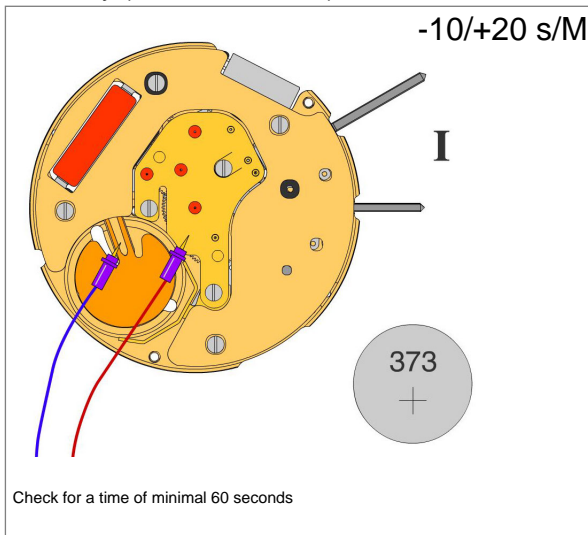

#### Resistance of the coil

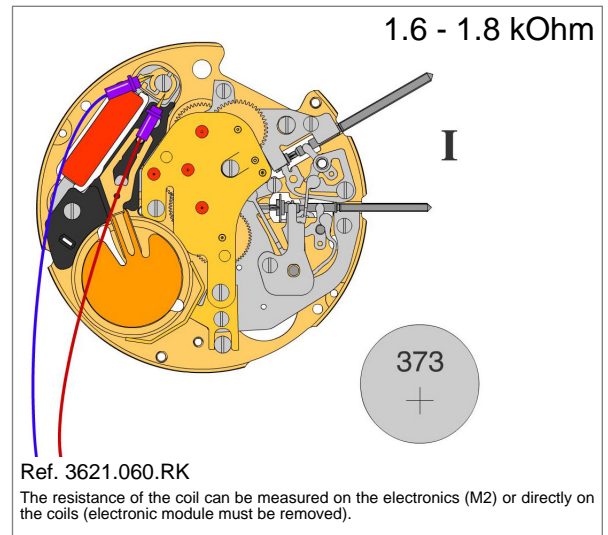

### Electrical checking

#### Coil insulation

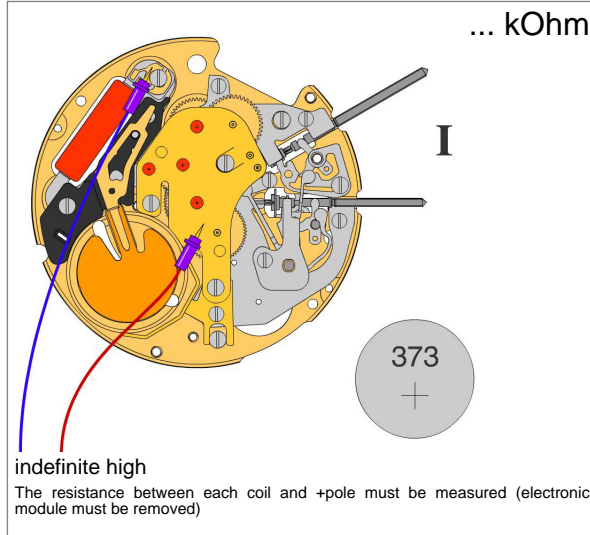

#### Accelerated test of movement

