

PARTS CATALOGUE/ TECHNICAL GUIDE

Cal. 7T32A

[SPECIFICATIONS]

Cal. No.		7T32A		
Item				
Movement				
Movement size	Outside diameter	ϕ 27.6mm 24.0mm between 3 o'clock and 9 o'clock sides		
	Casing diameter	ϕ 27.0mm 24.0mm between 3 o'clock and 9 o'clock sides		
	Height	3.1mm (3.2mm including the battery portion)		
Time indication		Main time	Stopwatch function	Alarm function
		Hour, minute and small second hands	Minute and 1/5 second hands	Small hour and minute hands
Driving system		Step motor, 4 pieces		
Additional mechanism		<ul style="list-style-type: none"> • Electronic circuit reset switch • Train wheel setting device • Battery life indicator • Date calendar • Instant setting device for date calendar • Stopwatch function (Up to 30 minutes in 1/5 seconds) <ul style="list-style-type: none"> • Accumulated elapsed time measurement • Split time measurement • Alarm function (12-hour indication system) • Alarm test system 		
Loss/gain		Monthly rate at normal temperature range: less than 15 seconds		
Regulation system		Nil		
Measuring gate by quartz tester		Use 10-second gate.		
Battery		SEIKO SR927W, Maxell SR927W, SONY SR927W, EVEREADY 399 Battery life is approximately 2 years. Voltage: 1.55V		
Jewels		0 jewel		

HATTORI SEIKO CO., LTD.

PARTS CATALOGUE

Cal. 7T32A

Disassembling procedures Figs.: ① ~ ⑦⑦

Reassembling procedures Figs.: ⑦⑦ ~ ①

Lubricating:	Types of oil	Oil quantity
●▶	Moebius A	○◁ Normal quantity
○◁	SEIKO Watch Oil S-6	▷
○◁	Silicone oil 500,000 c.s.	▷ Extremely small

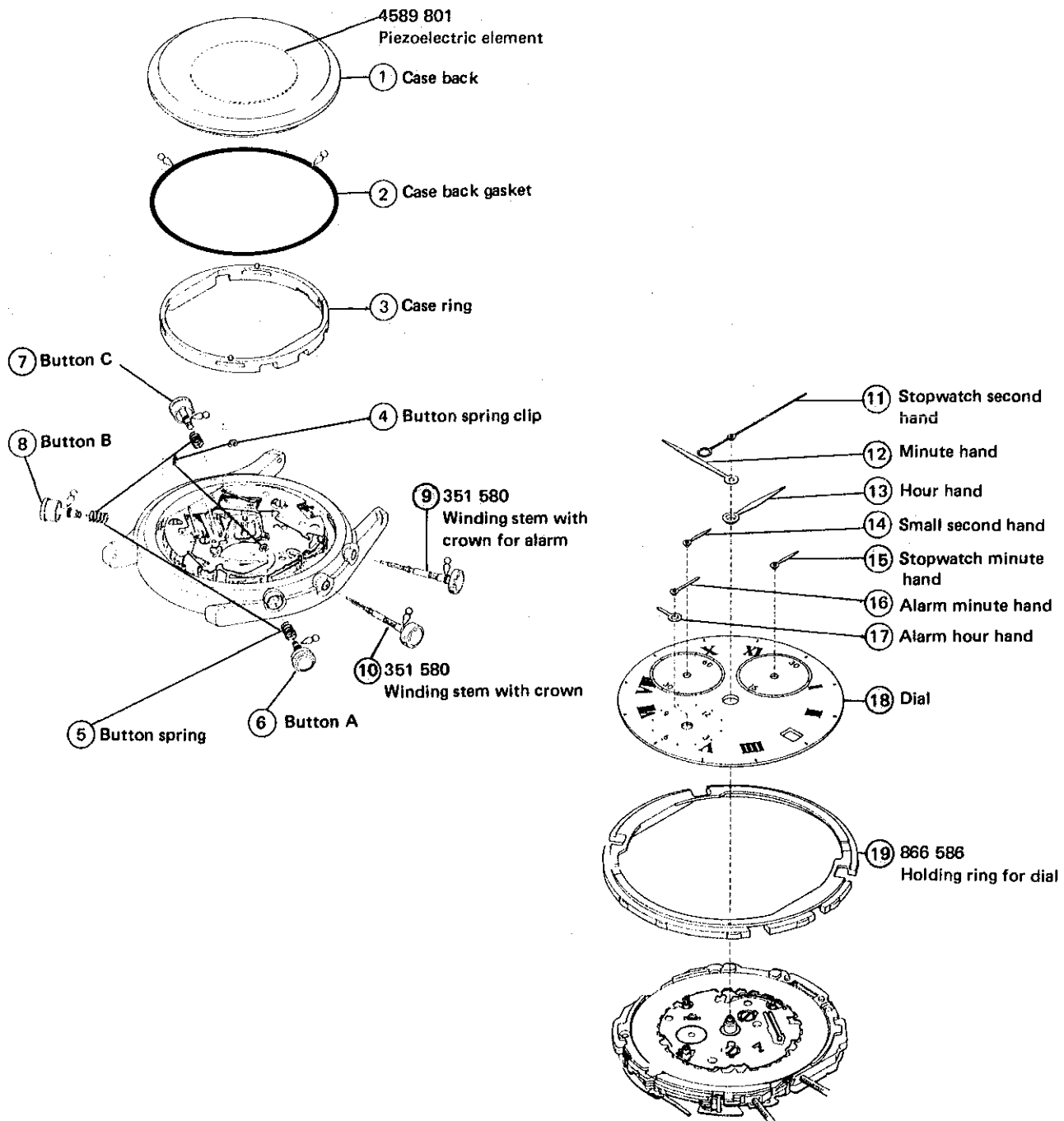

○ ➡ Please see the remarks on the following pages.

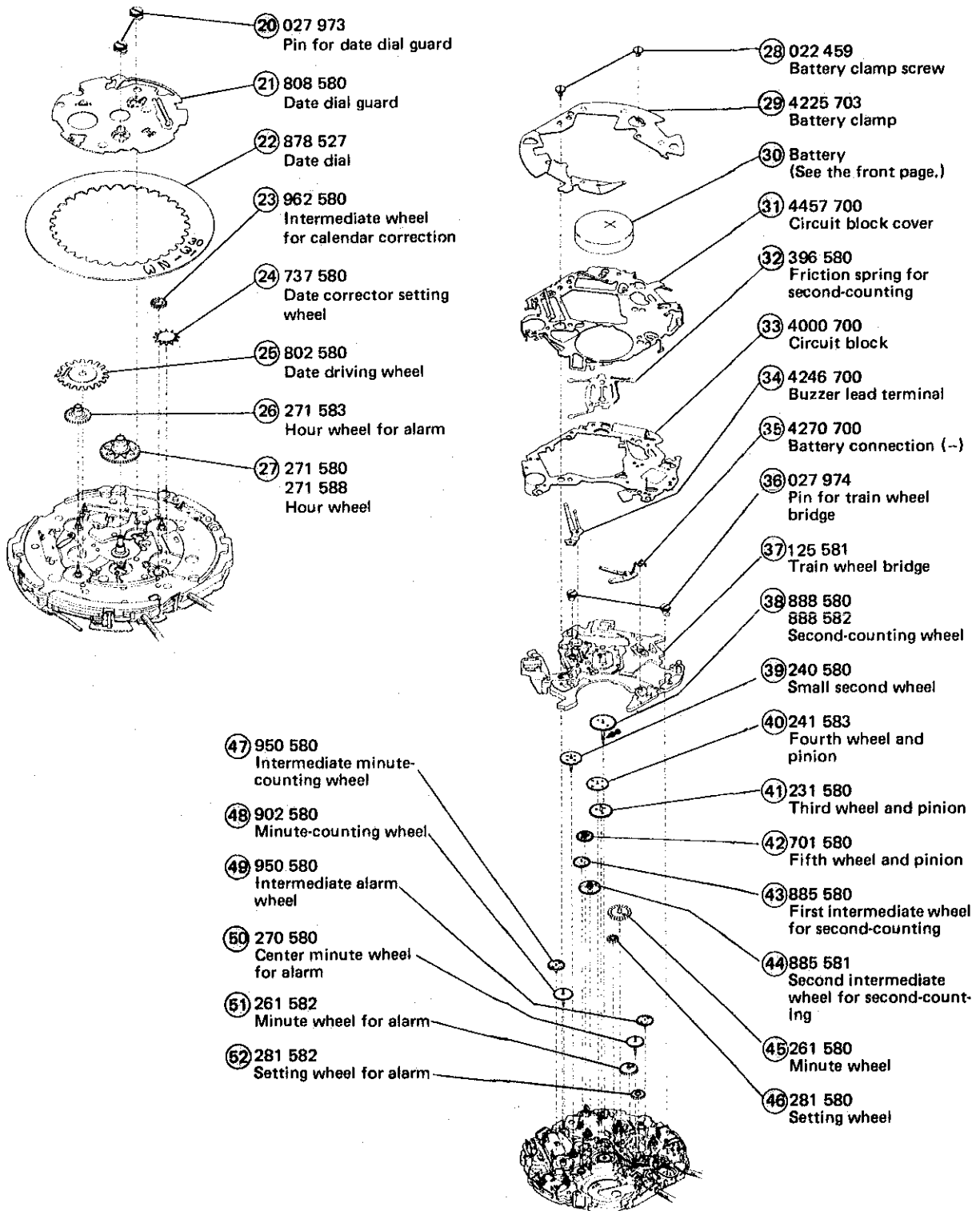

⊙ ➔ Please see the remarks on the following pages.

PARTS CATALOGUE

Cal. 7T32A

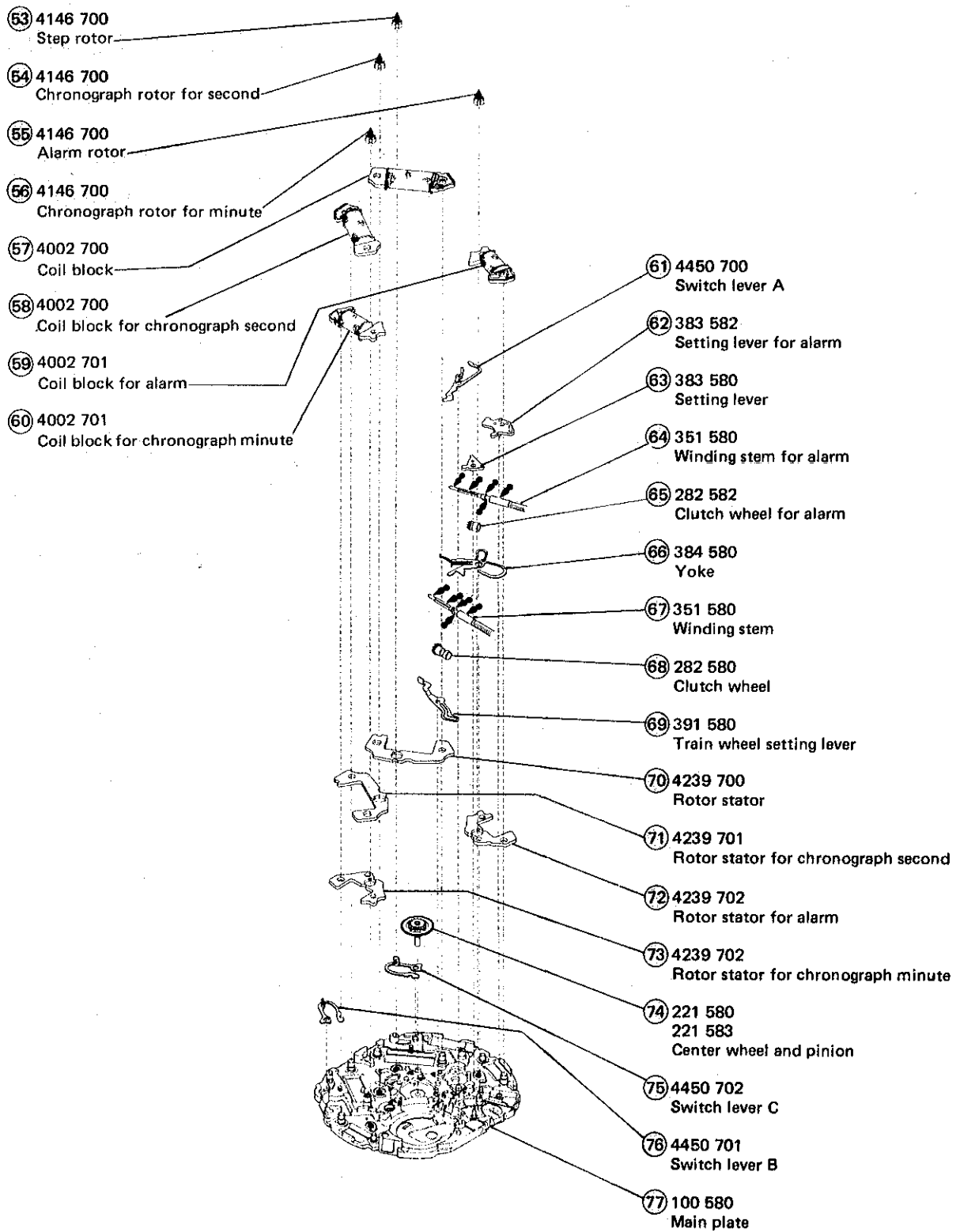

➡ Please see the remarks on the following pages.

PARTS CATALOGUE

Cal. 7T32A

Remarks:

①9 Holding ring for dial 866 586

The type of holding ring for dial is determined based on the design of cases.
Check the case number and refer to "SEIKO Casing Parts Catalogue" to choose a corresponding holding ring for dial.

②2 Date dial 878 527 (black figures on white background)





Used when the crown and calendar frame are located at the 3 o'clock position.
The type of date dial is determined based on the design of cases.
If any other type of date dial is required, check the case number and refer to "SEIKO Casing Parts Catalogue" or "List of Date Dial" to choose a corresponding date dial.

②7 Hour wheel

③8 Second-counting wheel

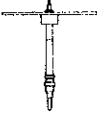
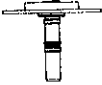
⑦4 Center wheel and pinion

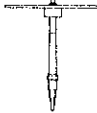
Combination

Parts name Type*	Hour wheel	Second-counting wheel	Center wheel and pinion
M	 271 580	 888 580	 221 580
L	 271 588	 888 582	 221 583

* Abbreviation M Standard type
(Movement type) L Long type

⑥4 Winding stem for alarm

⑥7 Winding stem

The type of winding stem for alarm and winding stem are determined based on the design of cases.
Check the case number and refer to "SEIKO Casing Parts Catalogue" to choose a corresponding winding stem.

②0 Pin for date dial guard

③6 Pin for train wheel bridge

For distinction between the pins, see the illustration below.

[Pin for date dial guard]



027 973

[Pin for train wheel bridge]

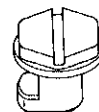

027 974

- The explanation here is only for the particular points of Cal. 7T32A.
- For the repairing, checking and measuring procedures, refer to the "TECHNICAL GUIDE, GENERAL INSTRUCTIONS".

I. STRUCTURE OF THE CIRCUIT BLOCK

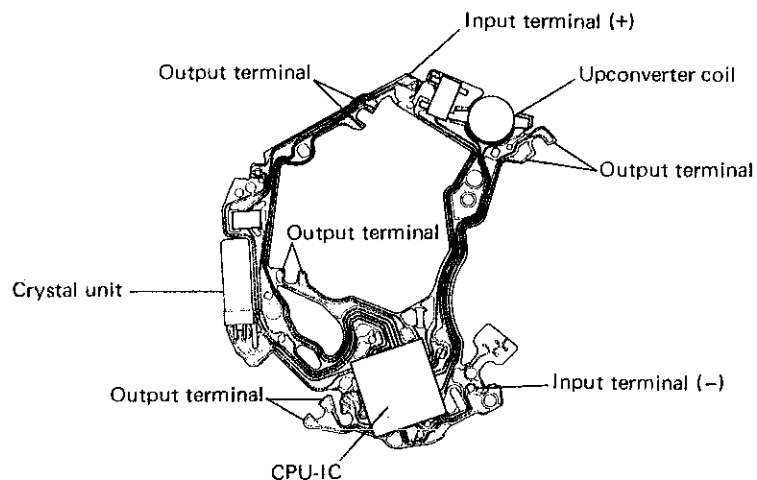

II. REMARKS ON INSTALLING THE BATTERY

- **A necessary step after installing the battery**
 - After the battery is replaced with a new one, or after the battery is re-installed following the repairing procedures, be sure to short-circuit the AC terminal and the circuit block cover with tweezers to reset the circuit as shown in the illustration below.

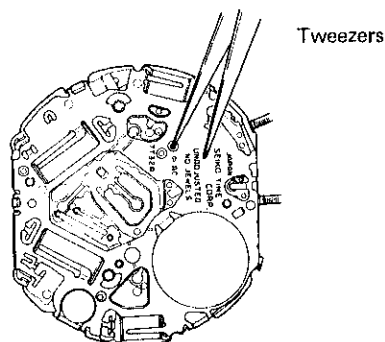

- After resetting the circuit, be sure to reset the stopwatch hands to the 12 o'clock position.
 - 1) Pull out the crown at the 3 o'clock side to the second click.
 - 2) Press button "B" to reset the stopwatch second hand to "0".
 - 3) Press button "A" to reset the stopwatch minute hand to "0".

*With each press of buttons "B" and "A", the stopwatch second and minute hands move 0.2 seconds and 0.5 minutes, respectively. They move automatically while the buttons are kept pressed and stop when they are released.

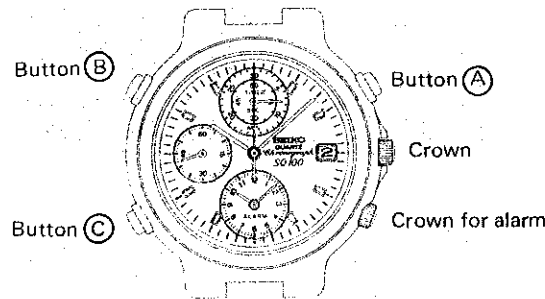

III. REMARKS ON DISASSEMBLING AND REASSEMBLING

Use the universal movement holder for disassembling and reassembling.

⑨ Winding stem with crown

⑩ Winding stem with crown for alarm

● **How to remove**

- Winding stem with crown at the 3 o'clock side:

Pull out the crown to the first click, and then push the setting lever by inserting the tip of tweezers into hole "A" in the illustration below.

- Winding stem with crown for alarm at the 4 o'clock side:

Pull out the crown for alarm to the first click, and then push the setting lever for alarm by inserting tweezers into hole "B" in the illustration below.

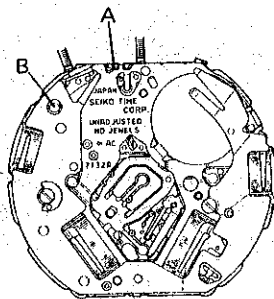

● **Remarks on setting the winding stems**

The winding stems at the 3 o'clock and 4 o'clock sides can be used interchangeably. However, note that the type of crown differs depending on the length of winding stem and the design of cases.

⑪ Stopwatch second hand

⑮ Stopwatch minute hand

● **Remarks on installing**

When installing those stopwatch hands, check that they accurately point to the stopwatch scales on the dial.

⑪ Stopwatch second hand

• **Remarks on installing**

After installing the hands, check that there is a proper clearance between the stopwatch second hand and other hands.

⑱ Dial

• **Remarks on installing**

When installing the dial, make sure that its center is securely set at the proper position.

⑳ Pin for date dial guard

• **How to remove**

- 1) Turn the pins 90° counterclockwise to loosen them using a screwdriver.
- 2) Remove the pins with tweezers.

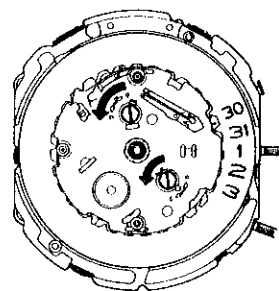

• **How to install**

- 1) Set the pins properly into the grooves.
- 2) Turn the pins 90° clockwise using a screwdriver to fix them.

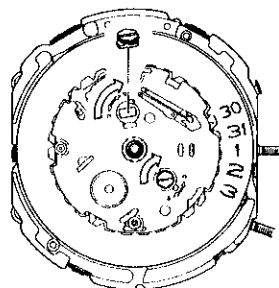

- Notes:**
- Never turn the pins more than 90° clockwise or counterclockwise.
 - Never apply undue force to the pins in turning them using a screwdriver.
 - Be sure to use a screwdriver that fits in with the slot of the pin head.

• **Lubricating**

Lubricate the date jumper and the tips of the date dial as shown in the illustration below.

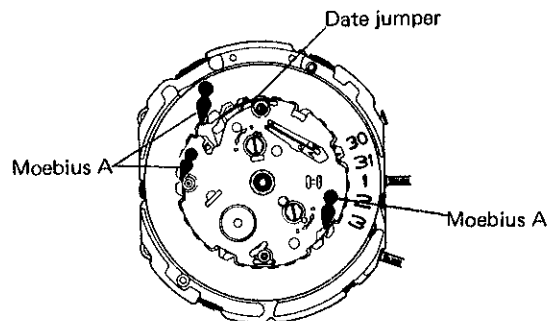

②⑦ Hour wheel

• Remarks on installing

When installing the hour wheel, be sure to engage it securely with the pinion of the minute wheel.

③⑩ Battery

• Remarks on installing

After installing the battery, be sure to reset the circuit with tweezers as shown in the illustration below.

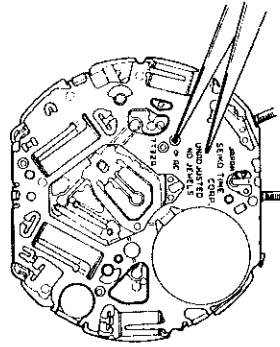

③① Circuit block cover

- Disassembling procedures ① ~ ⑦
- Reassembling procedures ⑦ ~ ①

• How to install

Be sure to install the circuit block cover securely at the hooking portion of the main plate.

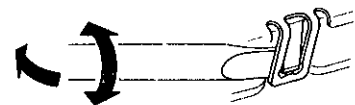
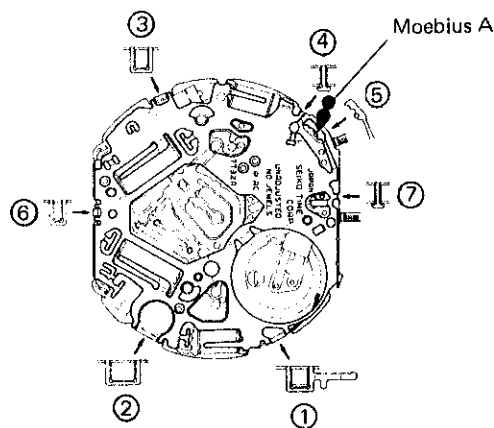

• Lubricating

Lubricate the click portion of the alarm yoke as shown in the illustration above.

32 Friction spring for second-counting

● Setting position

Slip the friction spring for second-counting into the gap under the train wheel bridge.

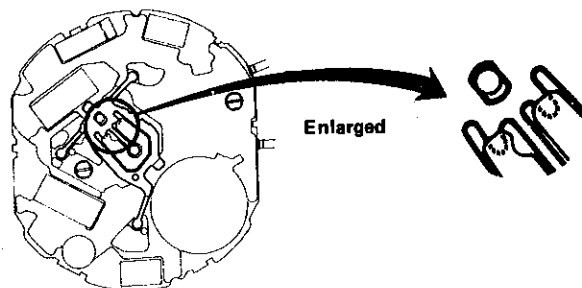

33 Circuit block

● How to install

Set the guide holes (a ~ f in the illustration) of the circuit block securely onto the corresponding collars of the train wheel bridge.

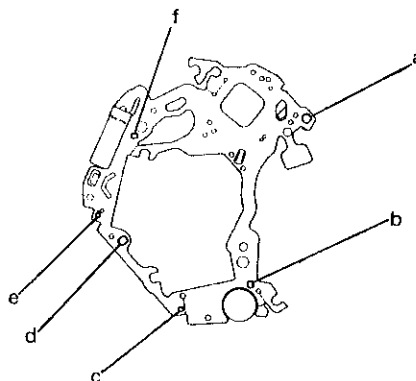

36 Pin for train wheel bridge

● How to remove

Turn the pins 90° counterclockwise to loosen them, and remove them with tweezers.

● How to install

Set the pins properly into the groove as shown in the illustration, and turn them 90° clockwise with a screwdriver to fix them.

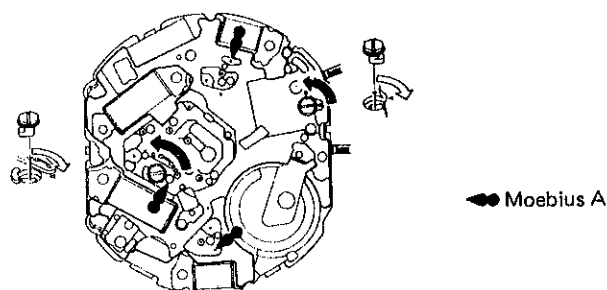

- Note:**
- Never turn the pins more than 90° clockwise or counterclockwise.
 - Never apply undue force to the pins in turning them using a screwdriver.
 - Be sure to use a screwdriver that fits in with the slot of the pin head.

- **Lubricating of the upper pivot for rotor**

After installing the train wheel bridge, lubricate the chronograph rotor for minute and chronograph rotor for second.

③⑦ Train wheel bridge

- **Remarks on installing**

- Before installing the train wheel bridge, check if the wheels are set in the proper position, referring to the photograph below. Also, check if their lower pivots are securely set in position using tweezers.
- Check that the pinion of each rotor securely engages with the proper gear, so that the upper pivots can be easily set in position when the train wheel bridge is installed.
- To set the upper pivots in position, first use a microscope and hold slightly down the train wheel bridge with tweezers. Then, lightly shake the train wheel bridge so that the pivots are put into position.

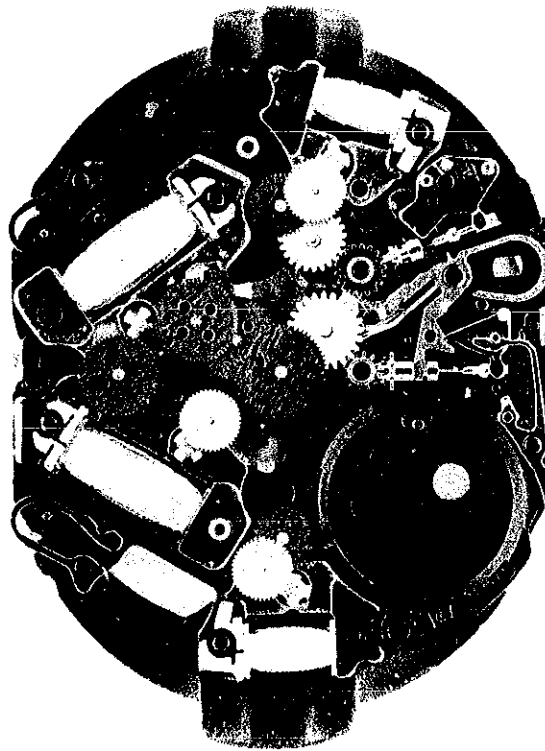

- Notes:**
- If the upper pivots cannot be set smoothly into the train wheel bridge, check the following points.
 - 1) Check if the lower pivot of each wheel is set in position.
 - 2) Check if the pinion of each rotor securely engages with the proper gear.
 - Do not press down the train wheel bridge forcibly.
 - Note that some of the axle holes are not used, depending on calibres. For Cal. 7T32A, the axle holes indicated in the illustration are not used.

These axle holes are not used for Cal. 7T32A.

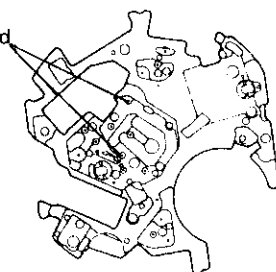

- (38) Second-counting wheel (52) Setting wheel for alarm

After disassembling the wheels and rotors, arrange them as indicated in the illustration below to facilitate the reassembling procedures. However, the rotors should be kept separately from each other, as they emit magnetism.

● **Setting position**

See the illustration below.

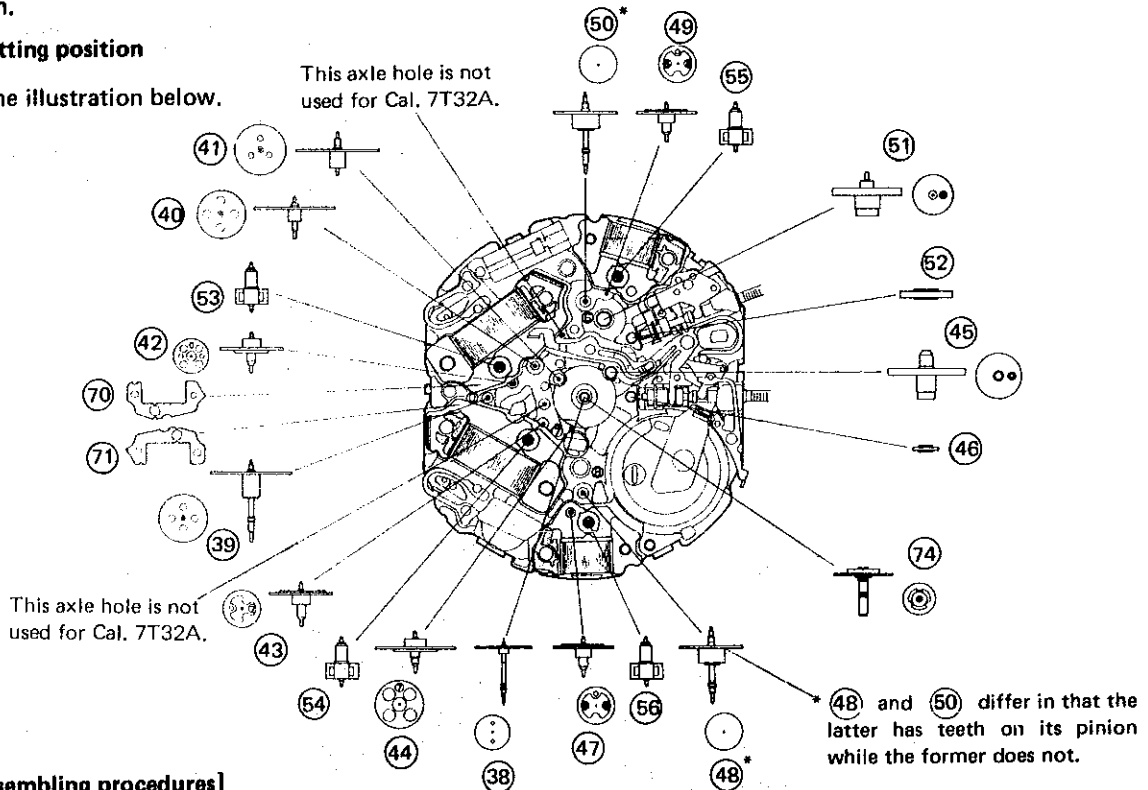

[Reassembling procedures]

- For the reassembling procedures of the parts below, refer to the exploded view on p. 4.

- | | |
|--|--|
| (74) 221 580, 221 583
Center wheel and pinion (Metal: gold) | (55) 4146 700 Alarm rotor (Plastic: white) |
| (71) 4239 701
Rotor stator for chronograph second | (54) 4146 700
Chronograph rotor for second (Plastic: white) |
| (70) 4239 700 Rotor stator | (53) 4146 700 Step rotor (Plastic: white) |
| (56) 4146 700
Chronograph rotor for minute (Plastic: white) | |

- Reassemble the parts below in the following order.

- | | |
|---|--|
| 1) (52) 281 582
Setting wheel for alarm (Metal: white) | 9) (44) 885 581
Second intermediate wheel for second-counting
(Plastic: green) |
| 2) (51) 261 582
Minute wheel for alarm (Plastic: white) | 10) (43) 885 580
First intermediate wheel for second-counting
(Plastic: white) |
| 3) (50) 270 580
Center minute wheel for alarm (Metal: gold) | 11) (42) 701 580
Fifth wheel and pinion (Plastic: green) |
| 4) (49) 950 580
Intermediate alarm wheel (Plastic: white) | 12) (41) 231 580
Third wheel and pinion (Metal: gold) |
| 5) (48) 902 580
Minute-counting wheel (Metal: gold) | 13) (40) 241 583
Fourth wheel and pinion (Metal: gold) |
| 6) (47) 950 580
Intermediate minute-counting wheel
(Plastic: white) | 14) (39) 240 580
Small second wheel (Metal: gold) |
| 7) (46) 281 580
Setting wheel (Metal: white) | 15) (38) 888 580, 888 582
Second-counting wheel (Metal: gold) |
| 8) (45) 261 580
Minute wheel (Plastic white) | |

- **Interchangeable parts**

- Step rotor, chronograph rotor for second, chronograph rotor for minute and alarm rotor (4146 700).
- Intermediate alarm wheel and intermediate minute-counting wheel (950 580).
- Rotor stator for alarm and rotor stator for chronograph minute (4239 702).

- **Parts having similar appearance**

- Minute-counting wheel and center minute wheel for alarm
 - * Minute-counting wheel's pinion has no teeth.
- Rotor stator and rotor stator for chronograph second
 - * Their notched portions differ in shape.

*The numerals inscribed on the plastic main plate refer to the block No.

⑥1 Switch lever A

⑦4 Center wheel and pinion

- **Setting position and lubricating**

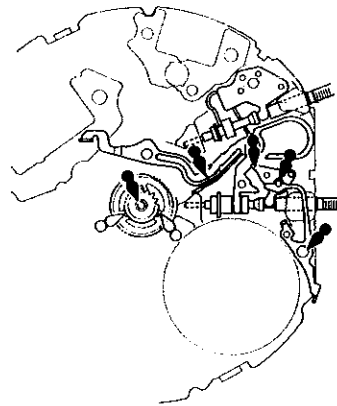

⑦5 Switch lever C

⑦6 Switch lever B

- **Setting position**

Switch lever C

Switch lever B

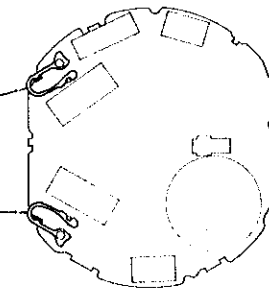

⑦7 Main plate

- **Lubricating**

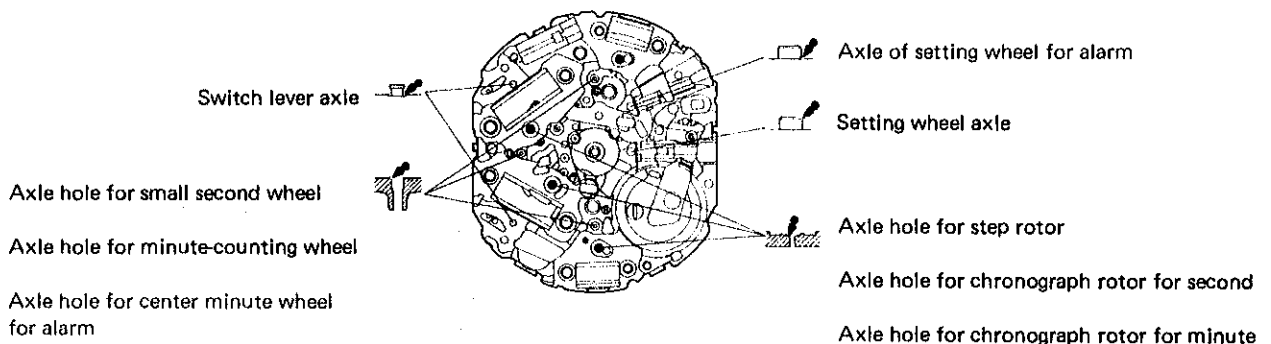

IV. CHECKING OF THE FUNCTIONS

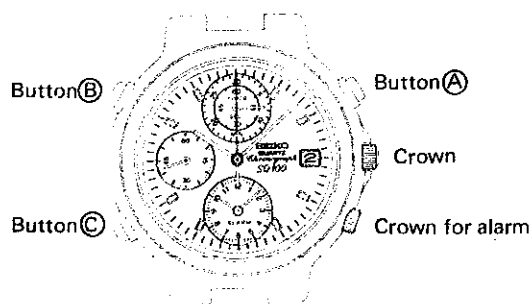

● ϕ -reset adjustment of the chronograph hands

- 1) Pull out the crown at the 3 o'clock side all the way to the second click.
- 2) Keep buttons "A" and "B" pressed at the same time for more than 1 second.
- 3) Press button "B" to reset the stopwatch second hand to "0".
- 4) Press button "A" to reset the stopwatch minute hand to "0".

*With each press of buttons "B" and "A", the stopwatch second and minute hands move 0.2 seconds and 0.5 minutes, respectively. They move automatically while the buttons are kept pressed and stop if they are released.

● Checking of the stopwatch function

- 1) Push back both crown at the 3 o'clock side and crown for alarm at the 4 o'clock side in to the normal position.
- 2) Press button "A" repeatedly to check if the stopwatch hands start and stop with each press of the button.
- 3) Press button "A" to stop the stopwatch, and then, press button "B" to check if the stopwatch second and minute hands reset to "0".
- 4) Press button "A" to start the stopwatch second hand, and then, press button "B" to check if the stopwatch second hand stops. After that, press button "B" again to check if the stopwatch second hand automatically advances the time elapsed while it was stopped and resumes the measurement.

* If the crown at the 3 o'clock side is pulled out all the way to the second click while the stopwatch is in use, the measurement is stopped and the stopwatch second and minute hands return to "0". However, even if the crown is pulled out to the first click, the date setting will be made possible but the stopwatch does not stop measuring.

* If the crown for alarm is pulled out to the first click (alarm is engaged) or second click (setting of the alarm hands is made possible) while the stopwatch is in use, the measurement is stopped and the stopwatch second and minute hands return to "0".

- **Checking of the alarm function**

- 1) Pull out the crown for alarm all the way to the second click and check if the warning sound beeps for one second. (The warning sound indicates that the designated alarm time has been canceled.)
- 2) Push the crown for alarm in to the first click from the second click, and check if the alarm sounds for approximately one minute.
- 3) Pull out the crown for alarm all the way to the second click to check the time indicated by the alarm hands, and then push it in to the first click. By doing so, the beeping sound continues. Press button "C" to stop it. Then, press button "C" again to advance the alarm hands one minute ahead of the time you have checked. Check if the alarm rings after one minute for 20 seconds and stops.

* The alarm is engaged when the crown for alarm is at the first click position. The crown at the 3 o'clock side has nothing to do with engagement/disengagement of the alarm.

V. VALUE CHECKING

- **Coil block resistance**

Coil block for alarm	:	1.8K Ω ~ 2.4K Ω
Coil block for chronograph minute	:	1.8K Ω ~ 2.4K Ω
Coil block for chronograph second	:	2.0K Ω ~ 2.6K Ω
Coil block	:	2.0K Ω ~ 2.6K Ω

- **Upconverter coil resistance** : 45 Ω ~ 60 Ω

- **Current consumption**

Before measuring current consumption, be sure to reset the circuit.

* Refer to "A necessary step after installing the battery".

For the whole of the movement

Time mode	:	less than 2.5 μ A
Stopwatch mode	:	less than 9.5 μ A

For the circuit block alone

Time mode	:	less than 1.8 μ A
-----------	---	-----------------------

- **Time accuracy**

When measuring the accuracy, make sure that the crown for alarm (at the 4 o'clock side) is at the first or second click position.