

SEIKO

QUARTZ *LC*

Cal.M154A

PARTS LIST

Calibre No.

M154A

Style Name

**QUARTZ LC
PERPETUAL CALENDAR**

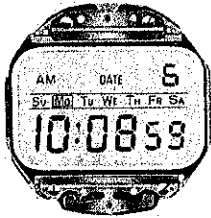

Characteristics :

- Casing diameter : ϕ 27.0 mm
- Maximum height : 6.1 mm
- Frequency of quartz crystal oscillator : 32,768 Hz
(Hz=Hertz Cycle per second)
- Time functions : Digital Display System showing hour, AM, PM, minute, second, day and date
- Calendar functions : Digital Display System showing day, date, month and year
- Display medium : Nematic Liquid Crystal, FE-Mode
- Time micro-adjustor : Trimmer condenser system
- Illumination light for digital display panel :
Illuminated in coordination with the button depressing

354 940

354 941

383 940

389 940

782 940

4007 946

4009 944

4032 944

4050 945

4219 940

4242 941

4256 940

4270 940

4277 940

4282 940

4282 941

4313 940

4398 940

4510 960

4521 500
4521 501

4540 940

4540 941

SEIKO SB-BU

022 256

023 061

023 067

$\frac{2}{1}$

Calibre No.		Style Name	
M154A		QUARTZ LC PERPETUAL CALENDAR	
PART NO.	PART NAME	PART NO.	PART NAME
354 940	Stem (Short)		
354 941	Stem (Long)		
383 940	Setting lever		
389 940	Setting lever axle spring		
782 940	Setting lever spring		
4007 946	LSI block		
4009 944	Crystal oscillator block		
4032 944	Bulb		
4050 945	Circuit bridge plate		
4219 940	Insulator for battery connection		
4242 941	Plus terminal of battery connection		
4256 940	Crystal holding spring		
4270 940	Battery connection		
4277 940	Contact lever guard		
4282 940	Contact lever A		
4282 941	Contact lever B		
4313 940	Connector		
4398 940	Liquid crystal panel frame		
4510 960	Liquid crystal panel		
4521 500	Reflecting mirror (Silver)		
4521 501	Reflecting mirror (Gold)		
4540 940	Spring for liquid crystal panel A		
4540 941	Spring for liquid crystal panel B		
022 256	LSI block screw		
022 256	Bulb holding screw		
022 256	Liquid crystal panel holder screw		
022 256	Circuit bridge plate screw		
022 256	Contact lever guard screw		
022 256	Crystal oscillator block screw		
022 256	Setting lever axle spring screw		
023 061	Battery connection pin		
023 067	Pin for plus terminal of battery connection		
SEIKO SB-BU	Silver oxide battery		

TECHNICAL GUIDE

SEIKO DIGITAL QUARTZ

CAL. M154A

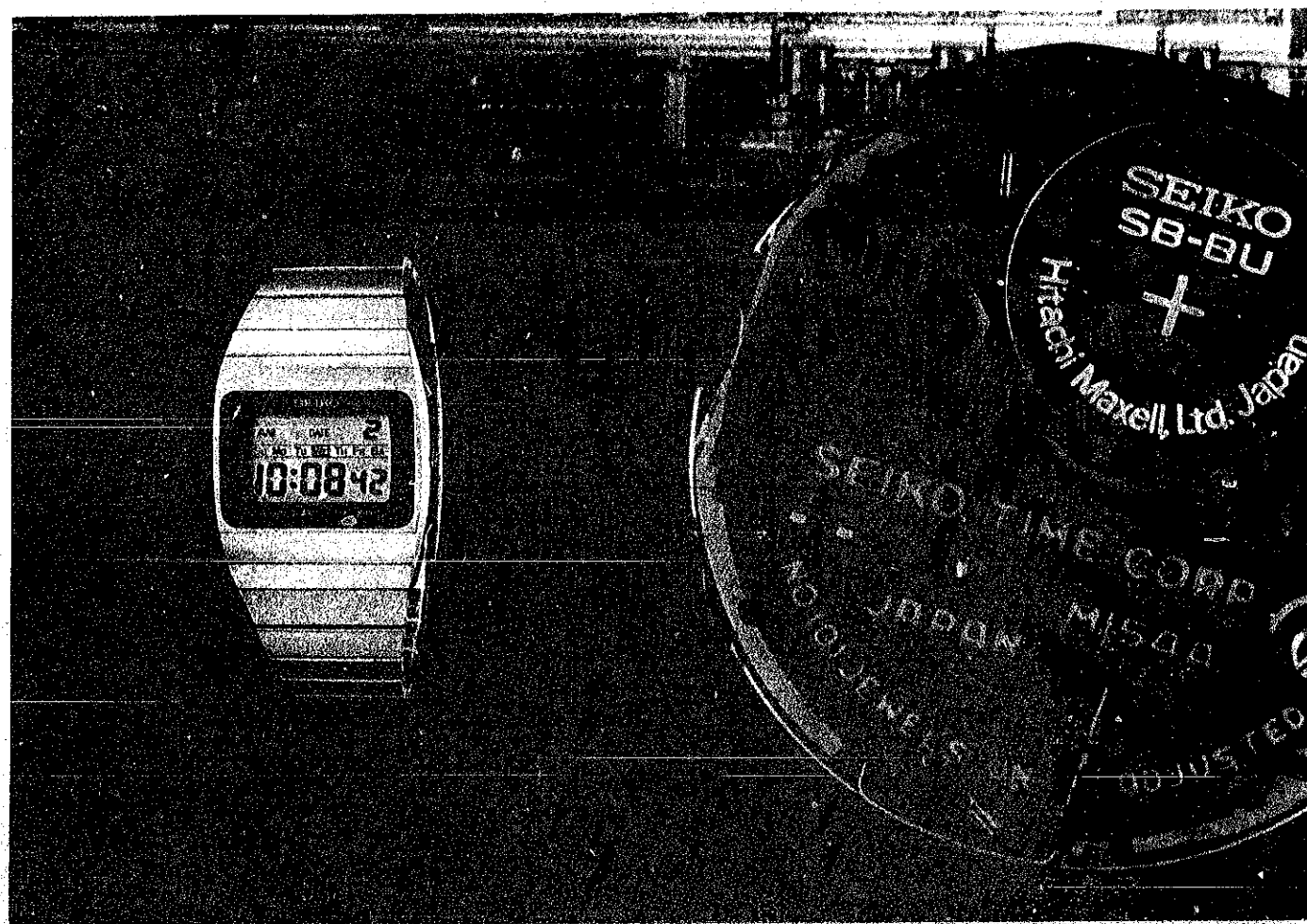

CONTENTS

I. SPECIFICATIONS AND FEATURES	1
1. Specifications	1
2. Features	1
II. HOW TO USE	2
1. Display	2
2. Button operation	2
3. How to set the time and calendar	2
III. DISASSEMBLING AND REASSEMBLING	4
1. After-sale servicing instruments and materials	4
2. Disassembling and reassembling of the case	7
3. Disassembling and reassembling of the movement and lubricating of the switch components	10
4. Cleaning	13
IV. CHECKING AND ADJUSTMENT	14
1. Guide table for checking and adjustment	14
2. Malfunction and checking points	15
3. Relationship between the segment (Liquid Crystal Panel Electrode) and the C-MOS-LSI output terminal	16
4. Procedure for checking and adjustment	17
A. Check battery voltage	17
• Check pattern segment checking system	17
• How to check battery electrolyte leakage and repair	17
B. Check conductivity of liquid crystal panel, LSI block and crystal oscillator block	18
C. Check liquid crystal panel, LSI block and crystal oscillator block	19
D. Check current consumption	20
E. Check accuracy	21
F. Check adjustment and functioning	21
G. Check bulb condition	21
H. Check conductivity of switch components	22
• Time Accuracy Adjusting	23

Calibre M154A

Movement
Display panel side

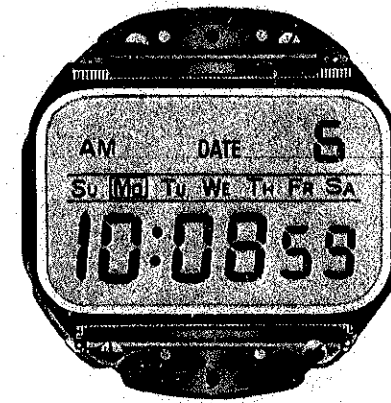

Time function

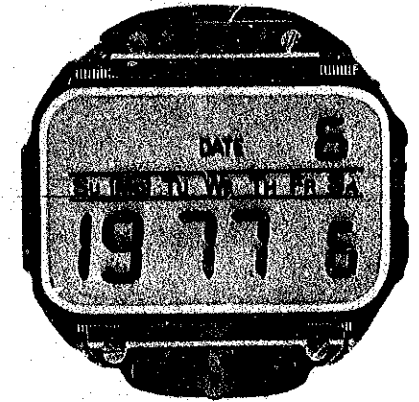

Calendar function

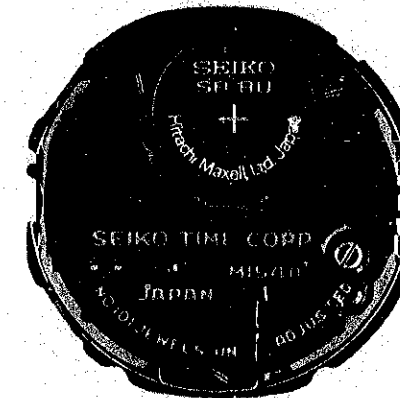

Crystal oscillator block side

I. SPECIFICATIONS AND FEATURES

1. Specifications

Item	Calibre No. M154A
Display medium	Nematic Liquid Crystal, FEM (Field Effect Mode)
Display system	Two-function changeover system <ul style="list-style-type: none"> Time function Digital display system showing hour, AM, PM, minute, second, date and day. Calendar function Digital display system showing year, month, date and day.
Additional mechanism	<ul style="list-style-type: none"> Illuminating light Pattern segment checking system
Crystal oscillator	32,768 Hz (Hz = Hertz cycle per second)
Loss/gain	Loss/gain at normal temperature range Mean monthly rate: less than 10 seconds Annual rate: less than 2 minutes. (Temperature compensation device)
Casing diameter	φ27.0 mm
Height	6.1 mm
Operational temperature range	-10°C ~ +60°C (14°F ~ 140°F)
Regulation system	Trimmer condenser
Battery power	SEIKO SB-BU silver oxide battery, Battery life is approximately two years.
IC (Integrated Circuit)	C-MOS-LSI 1 piece

2. Features

(1) Full function perpetual calendar watch

- Shows all necessary time indications such as hour, minute, second, date and day which are most frequently referred to in daily us, all of which are displayed at the same time on the wide liquid crystal panel. The time and calendar can be easily read.
- Even and odd months including February 29 are automatically adjusted by the special electronic circuit incorporated in Cal. M154A, thus eliminating any troublesome date adjustment at the end of each month.
- Month and year digits also are displayed by depressing a button.
- With the full-calendar function being adopted, Cal. M154A is capable of displaying all calendar digits for the years up to 2009.

(2) Easy-to-read wide display panel

The use of a display panel that is wider than that of the conventional digital watch, makes it easier to read the time and calendar digits.

(3) Multi-functional digital watch

In spite of being a multi-functional digital watch, Cal. M154A is as easy to operate as the other SEIKO digital watches since it also is adopting their simple button operations.

II. HOW TO USE

1. Display

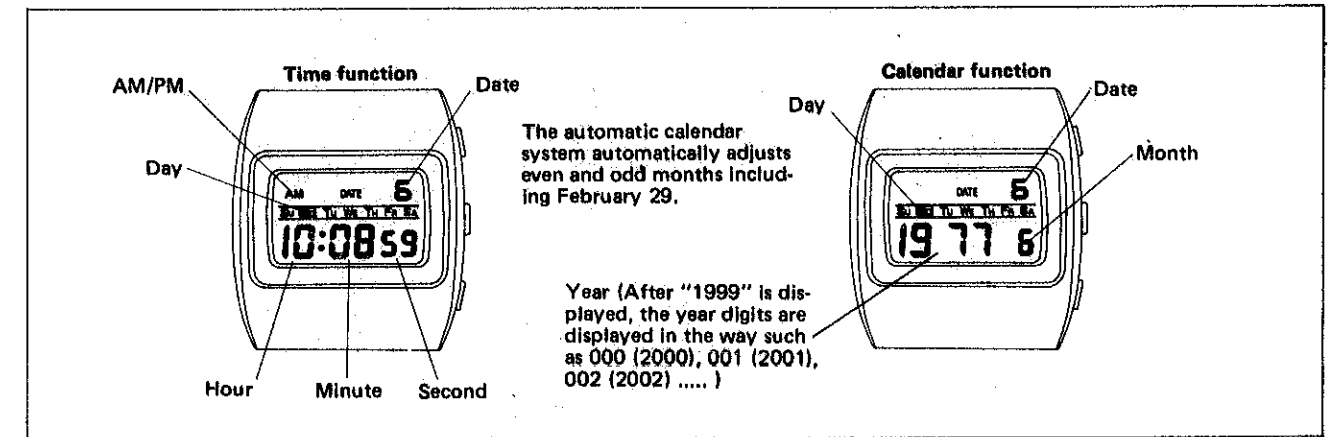

2. Button operation

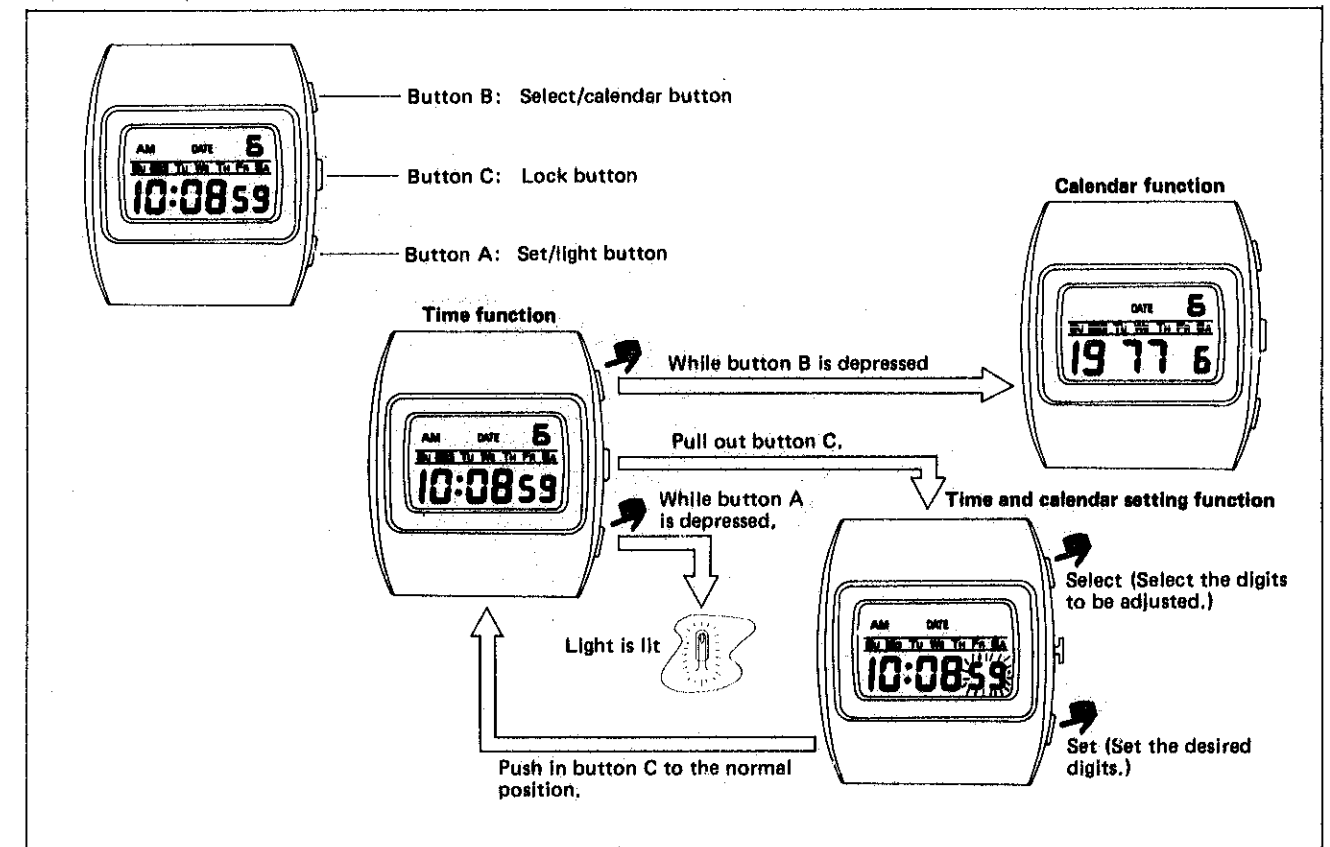

3. How to set the time and calendar

- Pull out button C, and the time and calendar digits are ready to be adjusted.
- Each depression of button B selects the digit (flashing) to be adjusted in the order shown in the illustration below.
- One digit (flashing) is advanced by each depression of button A. (The second digits are reset to "00" by depressing button A.)
- Whichever digits are being adjusted, the time function display is returned to normal operation by simply depressing button C.

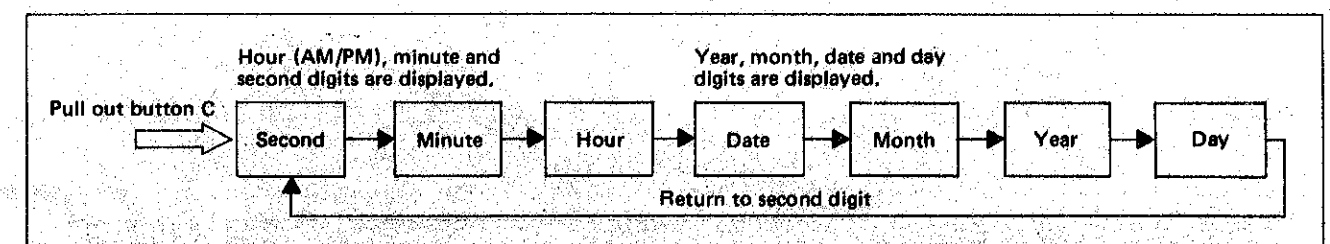

Example: How to change the indication of Monday, 10:08:42 A.M., March 24, 1975 Into Wednesday, 07:00:00 P.M., August 10, 1977.

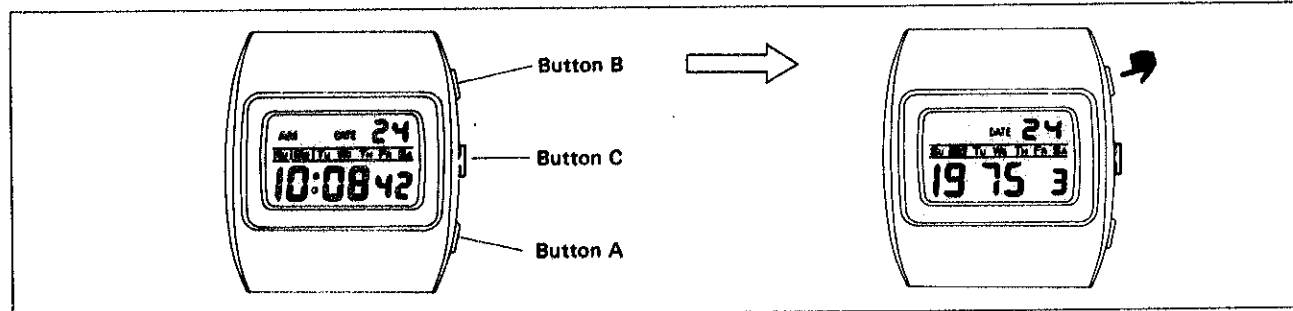

Digits to be adjusted (in the numerical order)	Button operation (Select and set.)	
	Select (Select the digits to be adjusted.) Each depression of button B selects the digits (flashing) to be adjusted in the numerical order.	Set (Set the desired digits.) One digit (flashing) is advanced by each depression of button A. (The second digits are reset to "00" by depressing button A.)
Second	Hour (AM/PM), minute and second digits are displayed. Pull out button C.	Depress button A in accordance with "00" second of a time signal and the seconds are then reset to "00" and start immediately. *
Minute	After setting the second digits, depress button B to start the minute digits flashing.	Set the desired minute.
Hour	Depress button B while the minute digits are flashing, and the hour digits and A.M./P.M. mark start flashing.	Be sure to check if it is set in the A.M. or P.M. period.
Date	Year, month, date and day digits are displayed, and the date digits start flashing.	(No change in display)
Month	(No change in display)	(No change in display)
Year	(No change in display)	After the digits "009" are displayed, the year digits will return to "1970".
Day	(No change in display)	Depress button B again and the second digits are ready to be set. Be sure to depress button C after the time and calendar setting is completed.

* (When the seconds count any numbers from "00" to "29", the seconds are reset to "00" automatically whenever button A is depressed. When the seconds count any numbers from "30" to "59" and button A is depressed, one minute is added and the seconds immediately return to "00".)

III. DISASSEMBLING AND REASSEMBLING

1. After-sale servicing instruments and materials

For after-sale servicing of SEIKO Quartz Digital Cal. M154A, the following instruments and materials are necessary.

(1) Quartz Tester QT-77

Used to check time accuracy (daily rate).
The microphone is electro-magnetic/electric-field detection microphone DM-1 for QT-77.

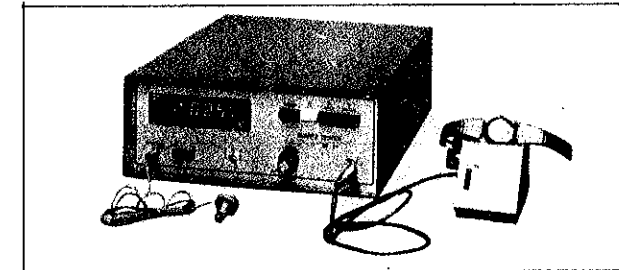

(2) Microtest MT-10II

Used to check current consumption and to flow voltage power constantly.

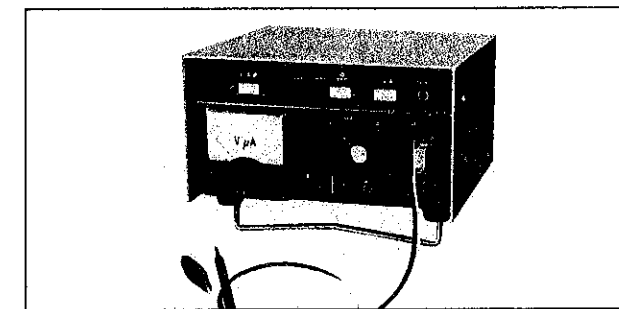

(3) Volt-ohm-meter

Used to check battery voltage and measure current consumption, etc.

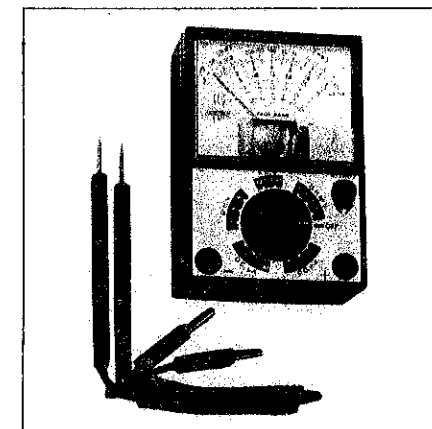

(4) Movement holder (S-644)

Used for disassembling and reassembling of the movement.
Can be used also for 0139, A031, M158 and M159.

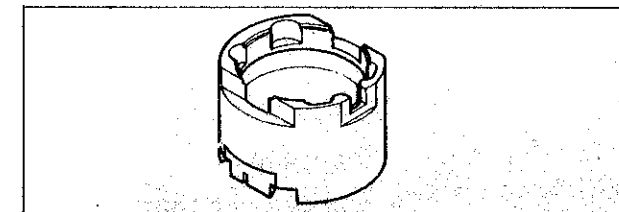

(5) Battery holding spring (S-815)

Used for securing battery and flowing current when the movement is removed from the case.
Can be used also for 0439, M158 and M159.

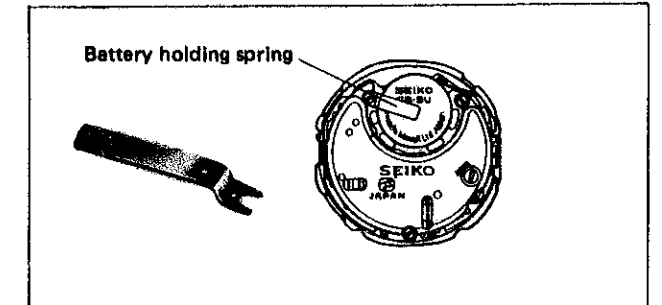

(6) Static electricity protector S-830

Used to protect C-MOS-LSI of Digital Quartz from being damaged by static electricity.

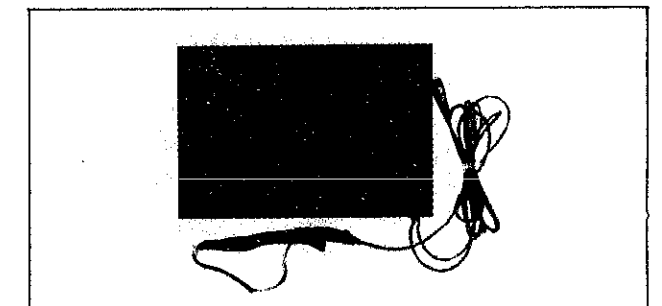

(7) Inserting disk (S-161)

Used to remove the glass.

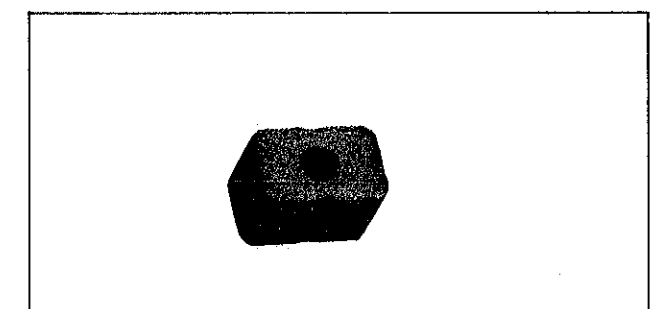

(8) Plastic supporting disk (S-173)

Used to reassemble the glass.

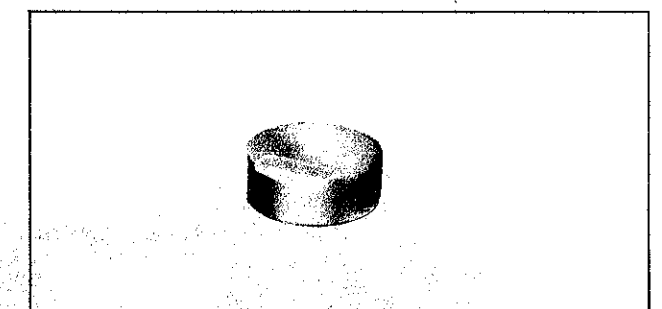

HOW TO USE QUARTZ TESTER QT-77

K. Hattori & Co., Ltd. has put on sale its new Quartz Tester QT-77. When measuring the watch accuracy by the new Quartz Tester QT-77, be sure to follow the instructions below.

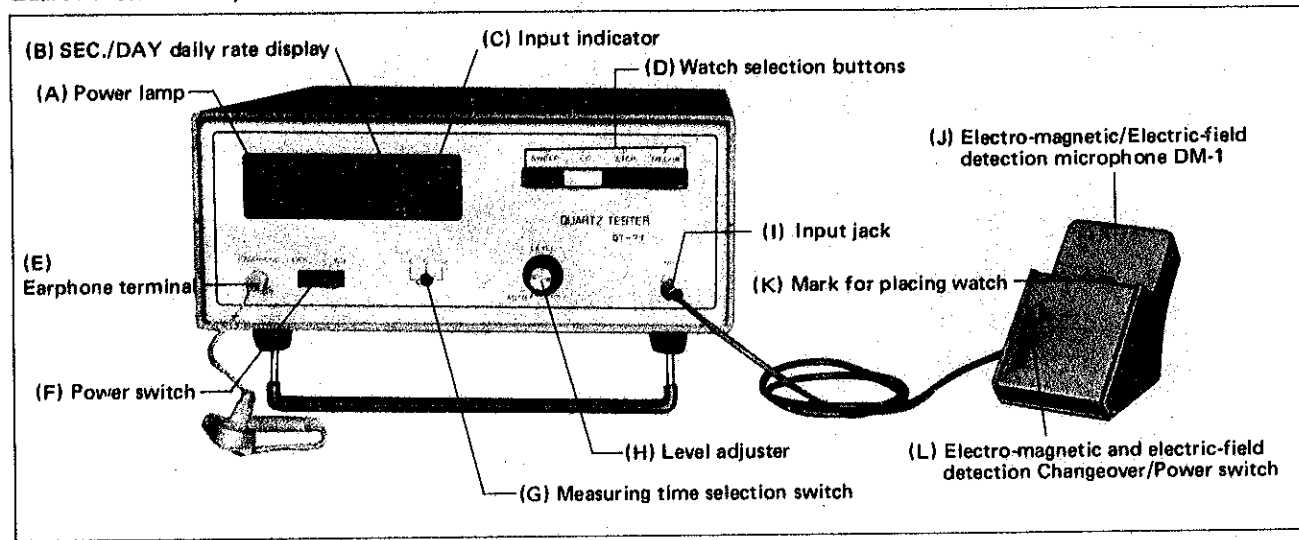

Preparations before measurement

- Make sure that the voltage indicated by the supply voltage setting switch is the same as the voltage rating of your household power supply. If it isn't, turn the fuse holder counterclockwise (arrow-marked direction) and remove the fuse. Pull out the supply voltage setting switch and adjust it to the voltage rating of your power supply, and set the fuse back in position.

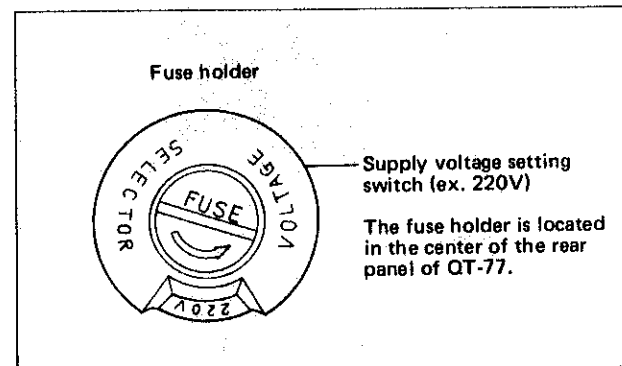

- Battery for Electro-magnetic/electric-field detection microphone DM-1
If the microphone is to be used for the first time, insert the battery (supplied along with the microphone) into the microphone. It is recommended to check the battery voltage periodically. (The voltage of each battery should be at least 1.5V.) When the microphone is not used turn the electro-magnetic and electric-field detection Changeover/Power switch to "STEP, SWEEP, LE" side, to preserve the battery life.

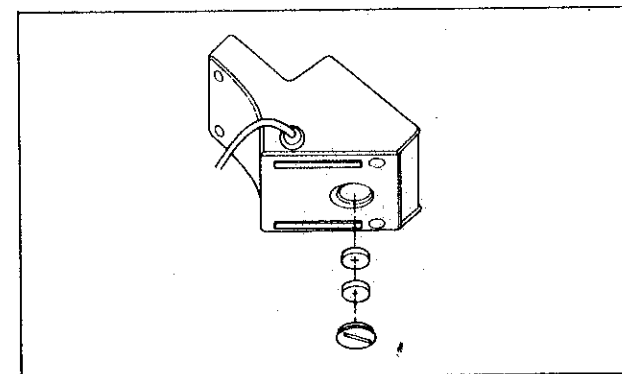

Measurement of time accuracy (daily rate)

1. With the power switch (F) off, insert the power supply cord plug into the power cord connector. Leave the Quartz Tester (QT-77) to stand for approximately 20 minutes.
2. Turn on the power switch (F). The power lamp (A) will light up.
3. Put the plug of the electro-magnetic/electric-field detection microphone DM-1 (J) all the way into the input jack (I).

4. Depress white button (LC) of the watch selection button.

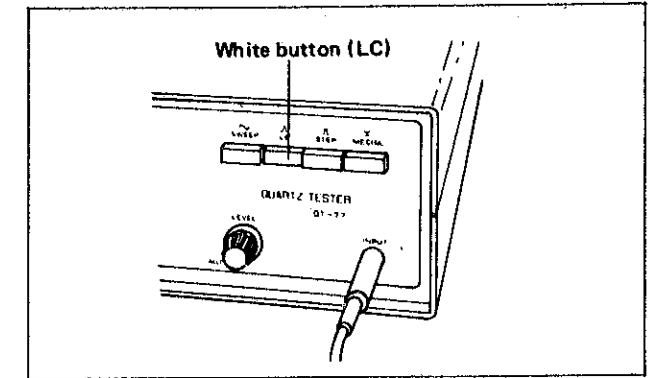

5. Set the measuring time selection switch (G) at "4 sec.", "6 sec." or "10 sec."
The daily rate can be measured at any position 4 sec., 6 sec. or 10 sec.
It is generally accepted, however, that the longer the measuring time is the more accurate will be the measurement.

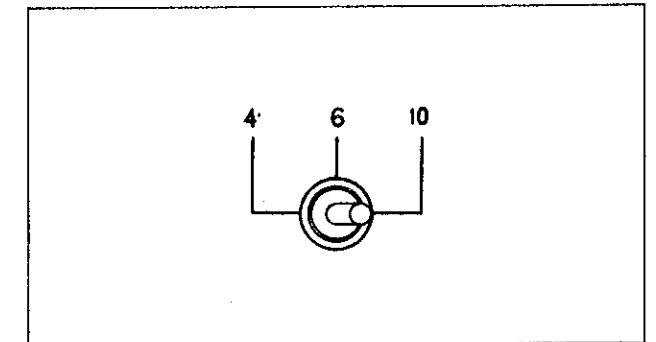

6. Insert the earphone cord plug into earphone terminal (E).
7. Turn the level adjuster (H) to AUTO position (turn it counterclockwise until a click is heard).
8. Push the switch (L) of the microphone (J) to the LC. ON position (electric-field detection function).
9. Place the watch on the microphone.
Place the watch with its liquid crystal display facing the mark (k) in the center of the microphone.

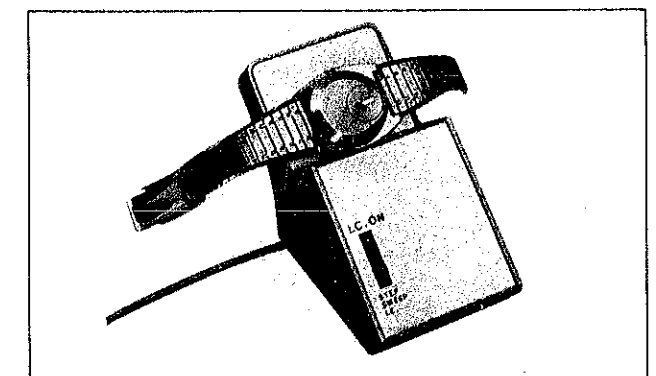

Put on the earphone, and move the watch on the microphone in various ways, for example by changing its position and angle, and the volume will change. Determine the watch position and direction where the earphone sound becomes loudest. At this time, the input indicator (C) will remain lit.

Note: In almost all cases, all the above procedure will do for the measuring the daily rate. If the input indicator flashes or does not light up at all, turn the level adjuster to keep the input indicator lit during measurement.

10. Read the daily rate on the display panel (B). If the daily rate of the watch exceeds the measurable range, it is not displayed on the panel.

Note: If there is any perspiration or oil on the glass of the watch, the Quartz Tester QT-77 does not pick up the signal.
Be sure not to put the watch in a vinyl bag when it is measured.

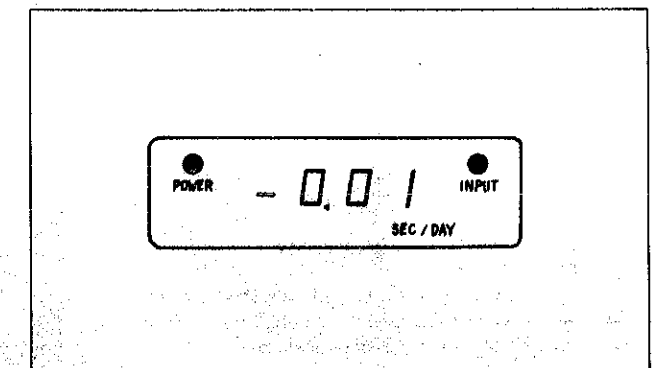

2. Disassembling and reassembling of the case

Lubricating  : Silicon grease 500,000 c.s.,
Normal quantity (Lubricate gaskets)

Disassembling procedures

Reassembling procedures

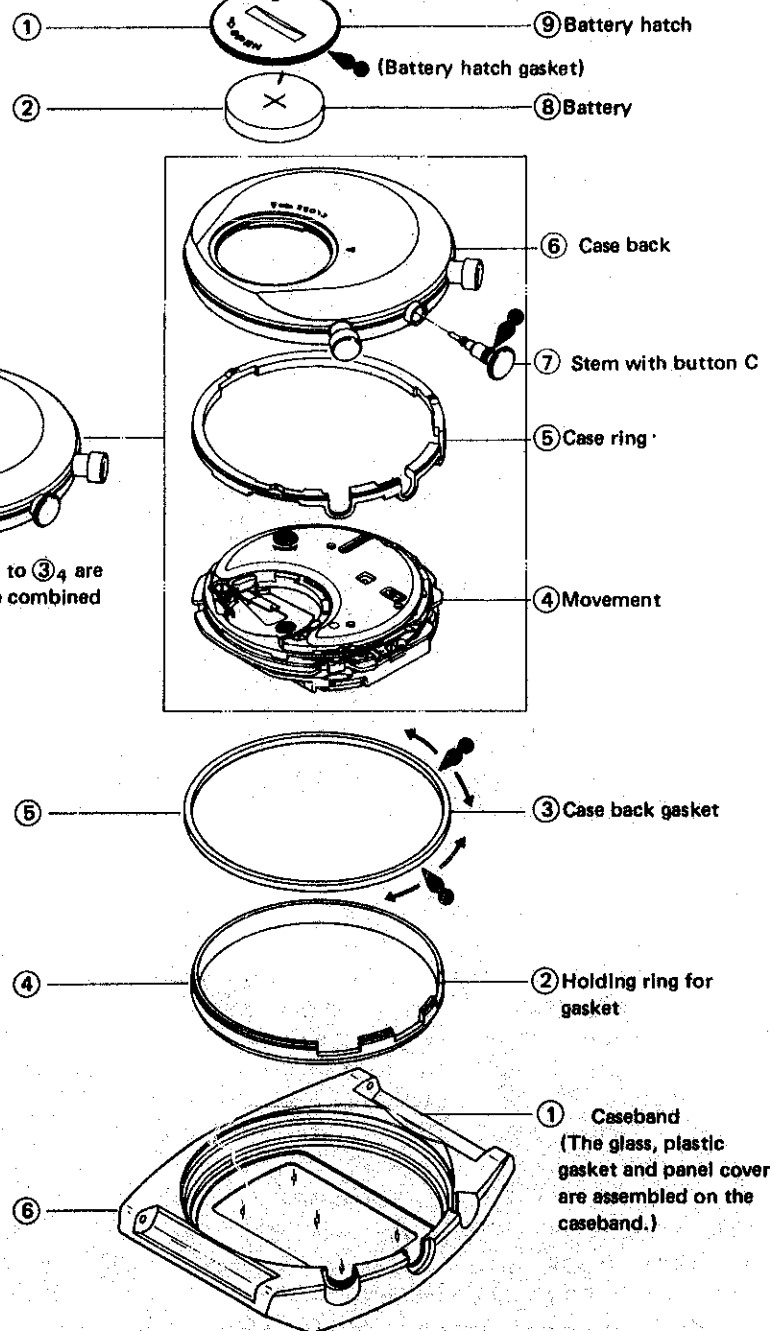

Turn the combined unit upside down for disassembling.

The parts from ③₁ to ③₄ are disassembled as one combined unit.

Buttons A and B
(It is not necessary to disassemble them under normal disassembling procedure. But when they are disassembled, be sure to lubricate.)

(Be sure to reassemble in the above order. If they are reassembled in reverse order, it might be difficult to reassemble or the gaskets may be twisted.)

Remarks for disassembling

- ③ The case back can be disassembled by pushing the case opener into the opening notch.
(The parts from ③₁ to ③₄ are disassembled as one combined unit.)

- Be sure to put a vinyl sheet on the tip of the case opener before inserting it into the opening notch not to scratch the caseband and the case back.

③₁ Stem with button "C"

- While pushing the arrow-marked portion with tweezers, pull out stem with button.

Remarks for reassembling

- ② Holding ring for gasket
- ④ Movement
- ⑤ Case ring

Reassemble the above three parts as shown in the illustration on the right. Make sure that they are reassembled in the correct position and direction.

⑥ Case back

- (i) Mount the case back evenly on the caseband while making sure that stem with button is fixed into the groove.
- (ii) Push the case back hard with fingers so that the caseband is snapped closed to the case back firmly as shown in the illustration. If it is not snapped closed with fingers, use SEIKO tightening tool.

⑦ Stem with button

- After reassembling, check to see if stem with button "C" is pulled out and depressed in correctly.

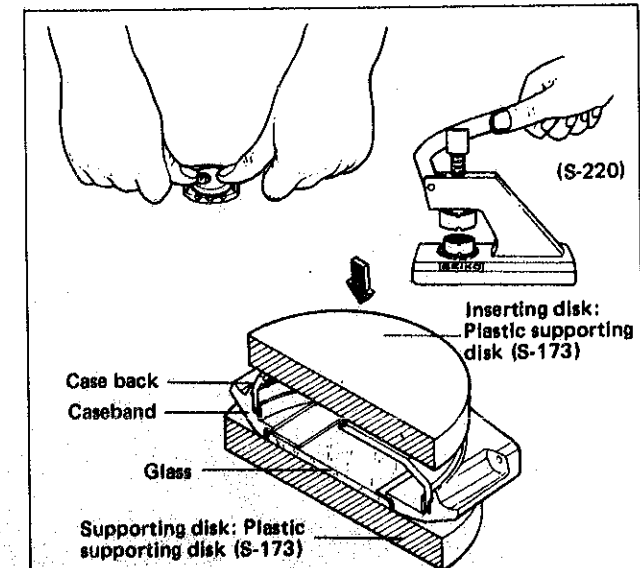
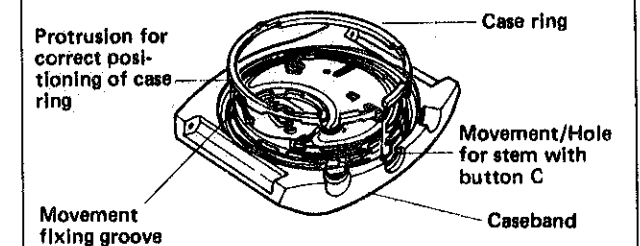
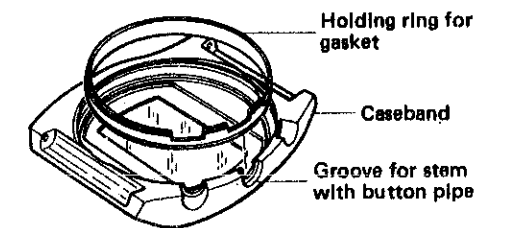
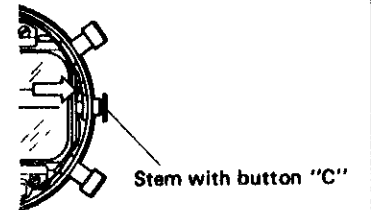
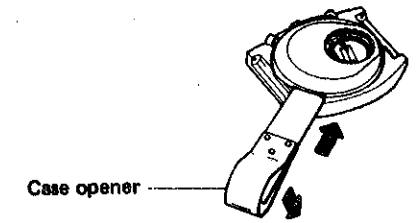

How to replace the glass

(As the glass is combined with the caseband, disassemble it only when the replacement of parts is necessary. Use the case tightening tool S-220.)

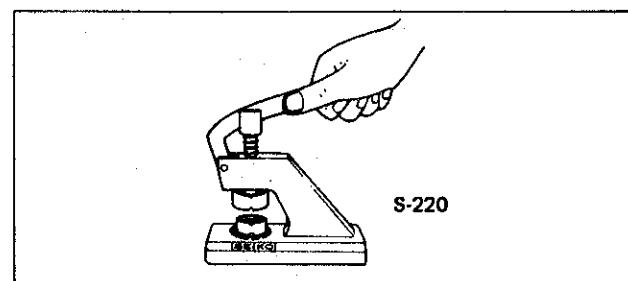

How to disassemble the glass

Use the Inserting disk S-161 to disassemble the glass.

(Or use the glass removing disk S-160 (φ16.5 ~ 17.5 mm) to disassemble the glass.)

Supporting disk: φ35.0 ~ 36.0 mm

- Place a vinyl sheet between the supporting disk and the glass as shown in the illustration.
- With S-161, push only the glass for disassembling.
- With S-160, push the glass together with the panel cover for disassembling.

Note: Push down the handle of S-220 slowly while making sure that the panel cover is not bent.

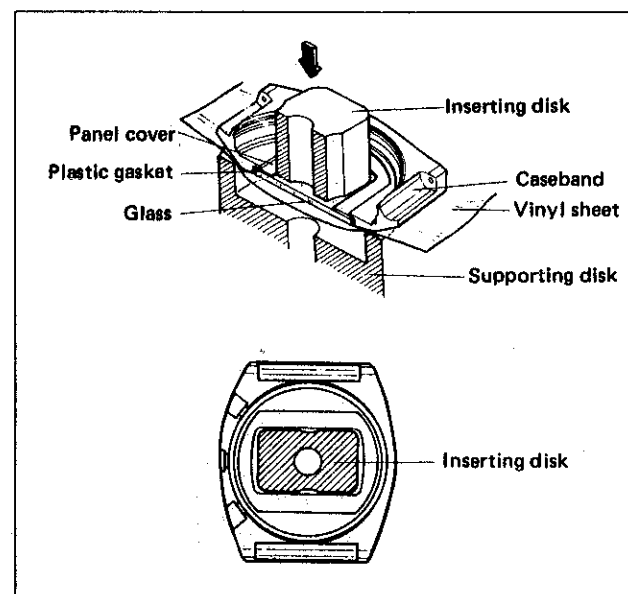

How to reassemble the glass

(i) Fix the plastic gasket

- Be sure to replace it with a new plastic gasket so as to maintain high water resistance.
- Do not mistake the upper side of the gasket for the lower side.

(ii) Fix the panel cover

Be sure to fix the back side of the panel cover firmly to the caseband.

(iii) Set the glass

Do not mistake the upper side of the glass for the lower side.

(iv) Push the glass in

(Inserting disk: Plastic supporting disk (S-173))
(Supporting disk: φ26.0 - φ26.5 mm)

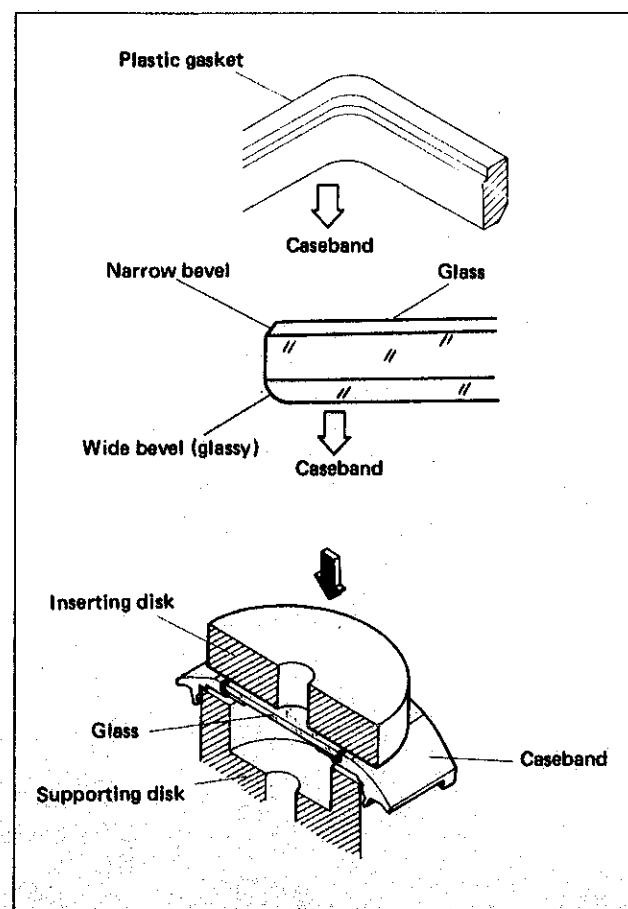

3. Disassembling and reassembling of the movement and lubricating of the switch components

Disassembling procedures Figs.: ① ~ ②④

Reassembling procedures Figs.: ②④ ~ ①

Lubricating: SEIKO Watch Oil, S-6, ∞ Normal quantity

(All the screws used are the same)

Note:

- After reassembling, hold the battery with the battery holding spring and check the display.
- If there is any display malfunction, move the connector slightly to the right or left as they may be out of the position.

Reflecting mirror ⑥

Note for disassembling and reassembling

- Be careful not to scratch the surface.
- Reassemble with the black coated side down.

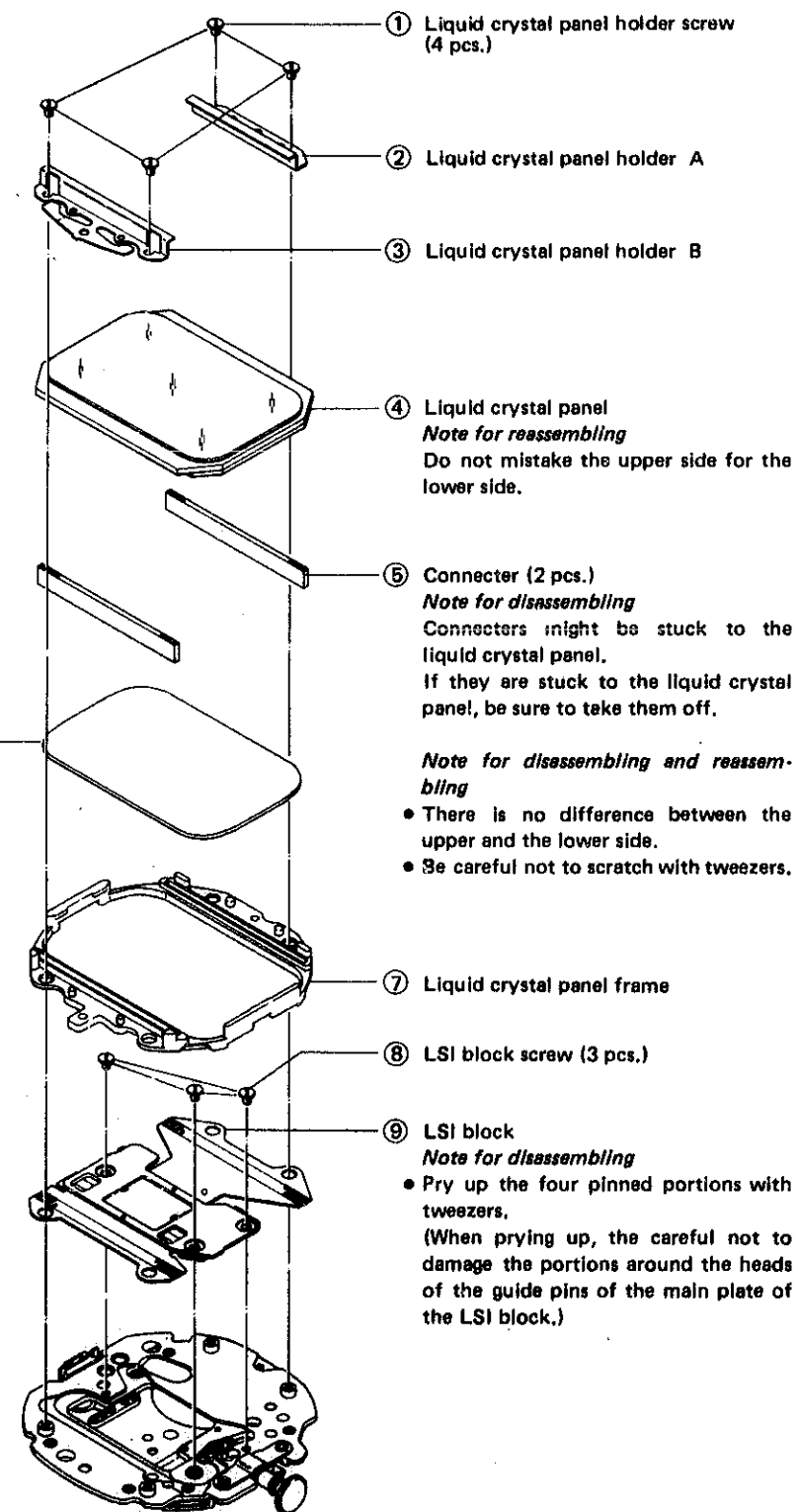

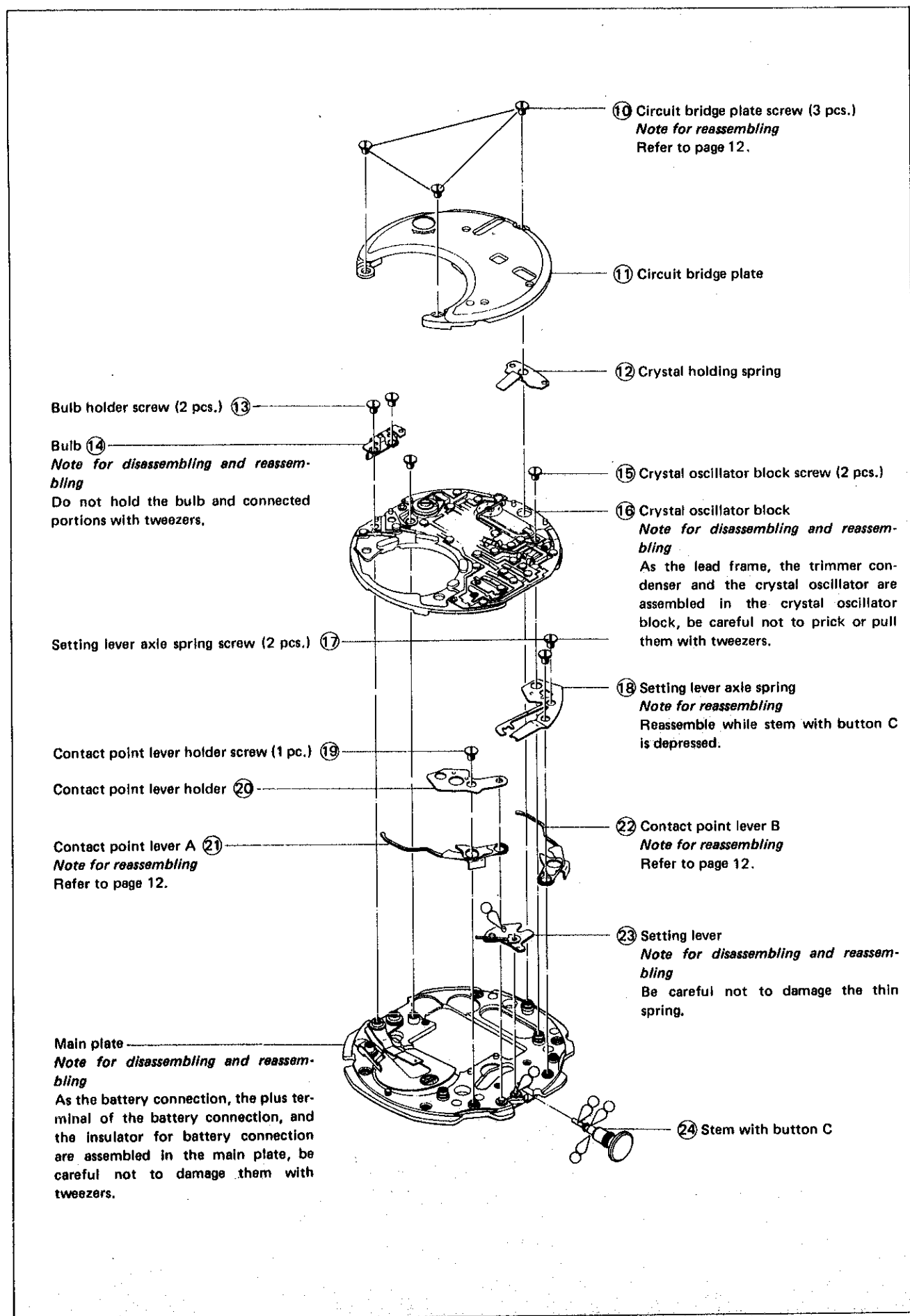

Remarks for reassembling

- 21 Contact point lever A
- 22 Contact point lever B

As the thin springs are welded to the contact point levers A and B, be careful not to bend the thin springs.

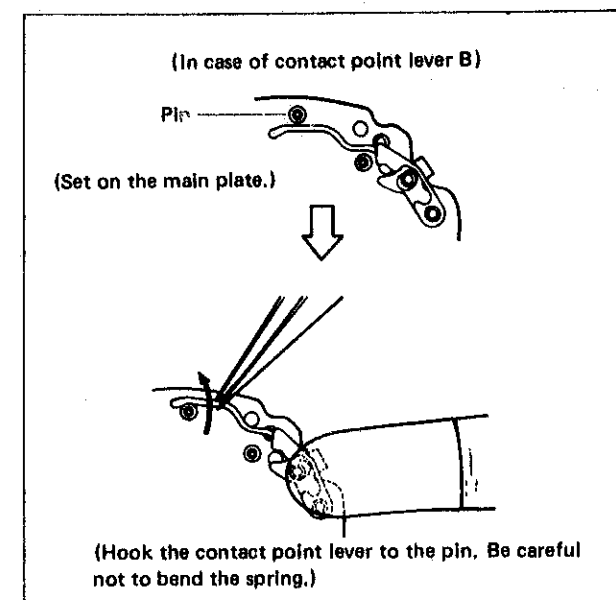

10 Circuit bridge plate screw

After reassembling up to the circuit bridge plate screws on page 11, check by following the procedures below.

- (i) Stem with button C in the normal position
Thin spring of the setting lever does not touch any portions.

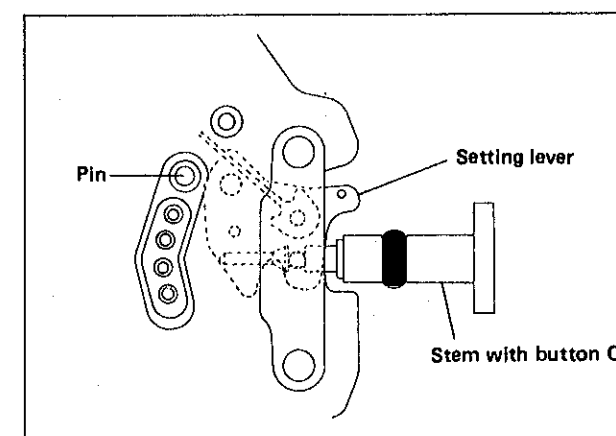



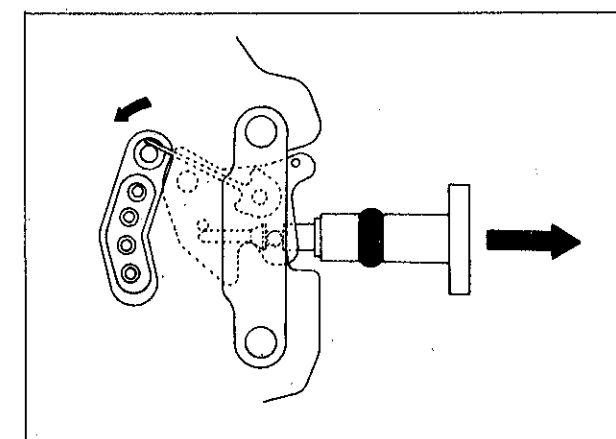

- (ii) Stem with button C in the pulled out position
The thin spring of the setting lever touches the pin and this changes the watch function into the time and calendar setting function.



4. Cleaning

Since several parts of Cal. M154 differ from those of the conventional mechanical watches, use the following method when cleaning.

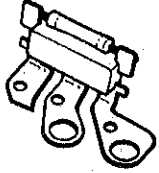
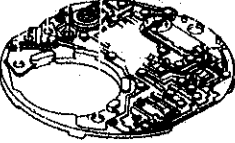
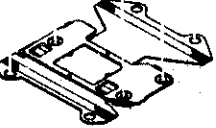
HOW TO CLEAN

Name of part	Cleaning	Drying	Solution	Remarks
Liquid crystal panel 	DO NOT CLEAN			Wipe dust and lint off with a soft brush.
Reflecting mirror 				Wipe the electrodes of the liquid crystal panel and the LSI block ONLY with a cloth moistened with benzine or alcohol.
Bulb 				
Crystal oscillator block 				
LSI block 				
Connector 	Rinse or wash with a soft brush.	Cool air	Alcohol	Do not use benzine or trichloroethylene. Dry thoroughly before reassembling.
Main plate Liquid crystal panel frame Circuit bridge plate	Rinse or wash with a soft brush.	Cool air	Benzine or alcohol Alcohol	
Other parts	Clean with cleaner, rinse or wash with a soft brush.	Cool or hot air	Trichloroethylene, benzine or alcohol	

IV. CHECKING AND ADJUSTMENT

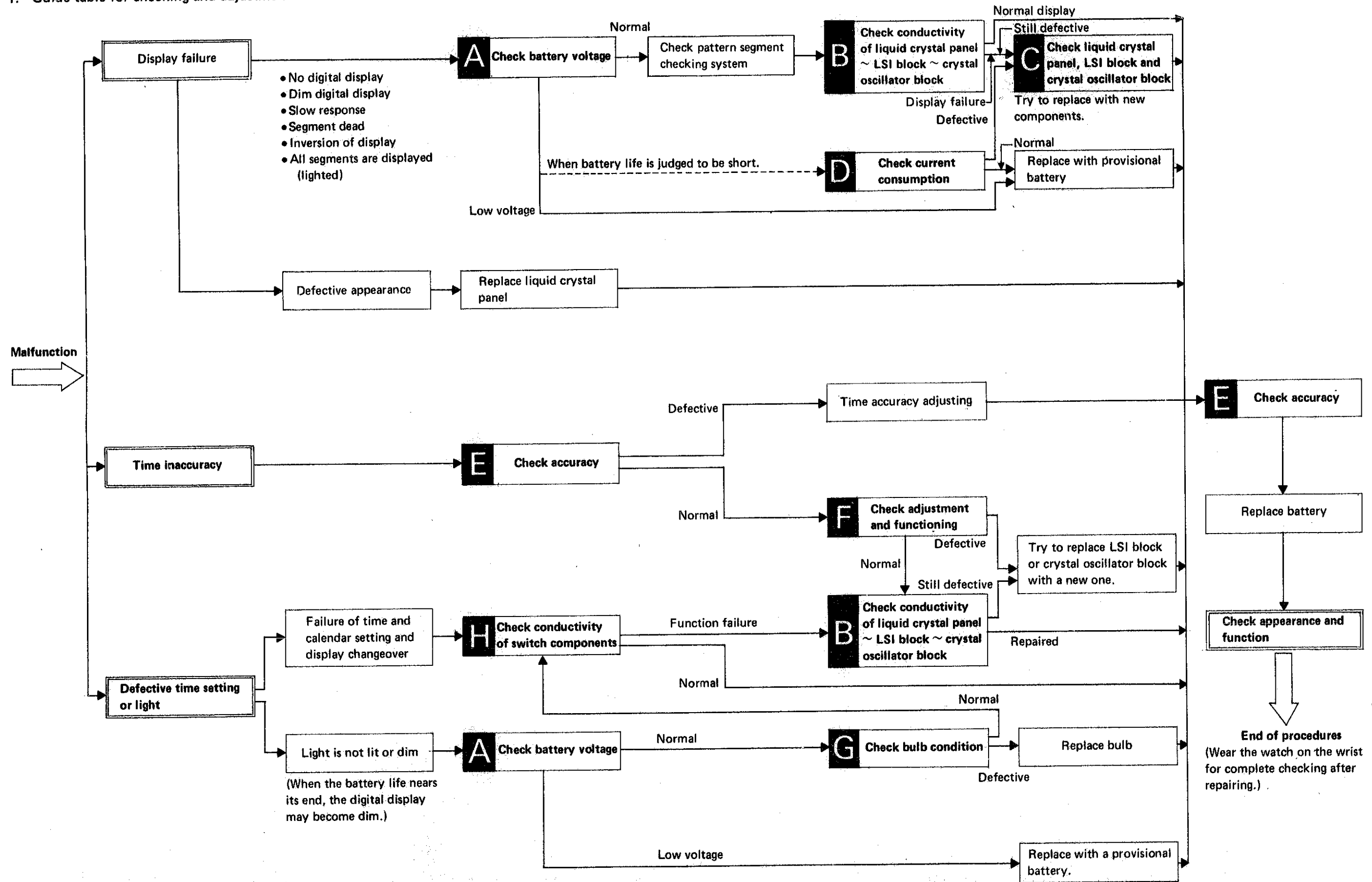

Be sure to use the Static Electricity Protector (S-830) when handling the movement.

1. Guide table for checking and adjustment



2. Malfunction and checking points

- Check in the numerical order.
- Refer to "Guide table for checking and adjustment" on page 14.

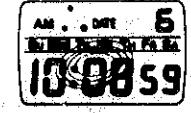
FAULTY SYMPTOMS		CHECKING POINTS								
		A		B	C			F	G	H
		Battery voltage	Lighting of all segments	Conductivity of liquid crystal panel, LSI block and crystal oscillator block	Liquid crystal panel	LSI block, crystal oscillator block	Time accuracy adjusting	Adjustment and functioning	Bulb	Switch components
DISPLAY FAILURE	No digital display, dim digital display or extremely slow response.	①		②	③	④				
	All segments are lighted.			①	②	③				
	<ul style="list-style-type: none"> • Some segments of the digital figures are not lighted. • The segment which should be on and off is reversed as shown in the illustration. 		①	②	③	④				
	<p>(Deflection) Some or all of one segment show different contact depending on the direction of view.</p> <p>Example: </p> <p>(Poor appearance) Some portions of the liquid crystal panel will have air bubbles or iridescent view.</p> <p>Example: </p>					①				
TIME IN ACCURACY	Gain or loss tested by Quartz tester.						①			
	Though Quartz tester indicates the normal figures, a watch gains or loses when it is worn on the wrist.			②		③		①		
DEFECTIVE TIME AND CALENDAR SETTING OR LIGHT	Failure of time and calendar setting or changeover of time and calendar display.			②		③				①
	Light is not lit or light is lit but dims soon.	①		④		⑤			②	③

3. Relationship between the segment (Liquid Crystal Panel Electrode) and the C-MOS-LSI output terminal

A complete knowledge of how the segment (Liquid Crystal Panel Electrode) works with the C-MOS-LSI output terminal will provide the correct procedures for checking and adjustment.

• Designation of segment

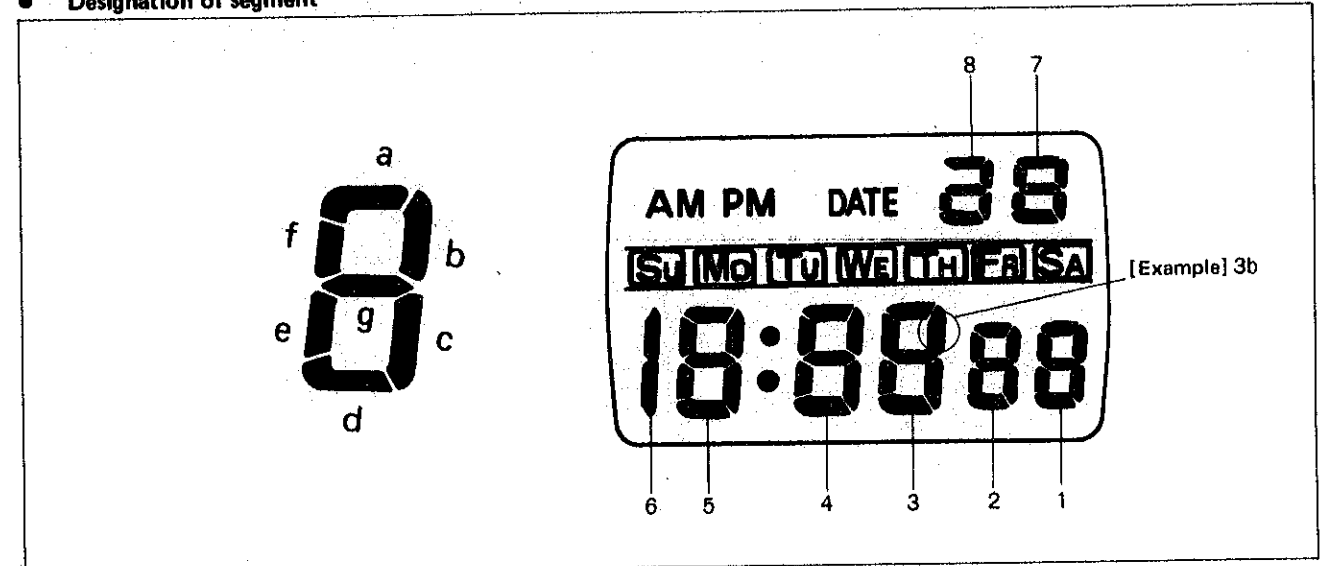

• Relationship between the segment and the C-MOS-LSI output terminal

The liquid crystal panel electrode is connected electrically with each segment which forms a digital figure as shown in the illustration of the panel pattern below.

(The panel pattern can be seen if the panel is slightly tilted and looked at in an angular position.)

Also, the liquid crystal panel electrode is connected electrically with the C-MOS-LSI output terminal by the connector.

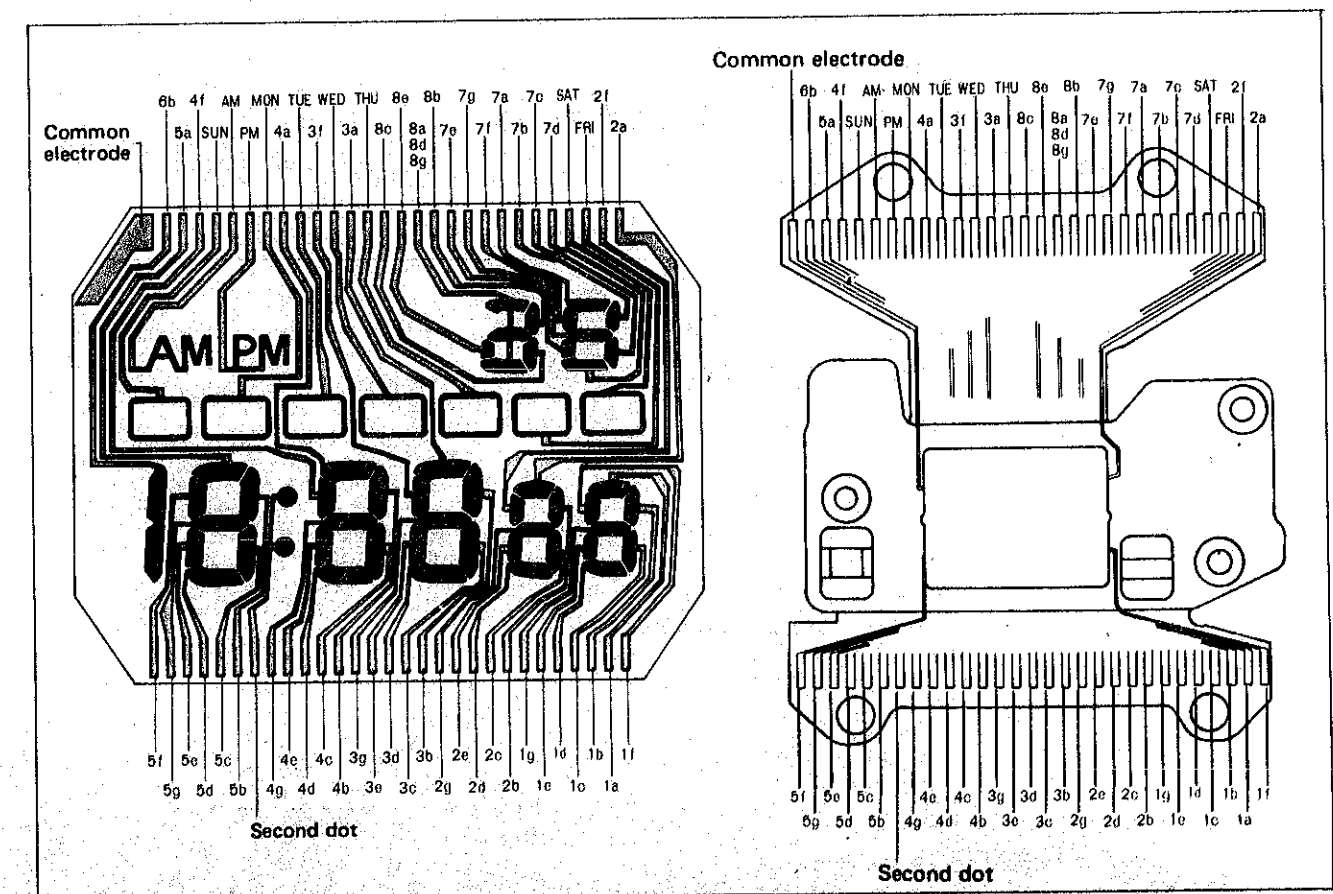

Note: Poor conductivity of the common electrode causes lighting of all segments or inversion of the display.

4. Procedure for checking and adjustment

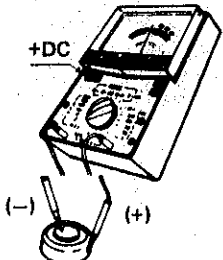
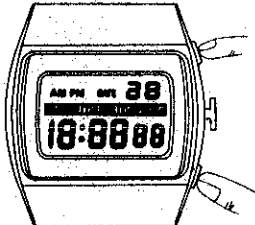
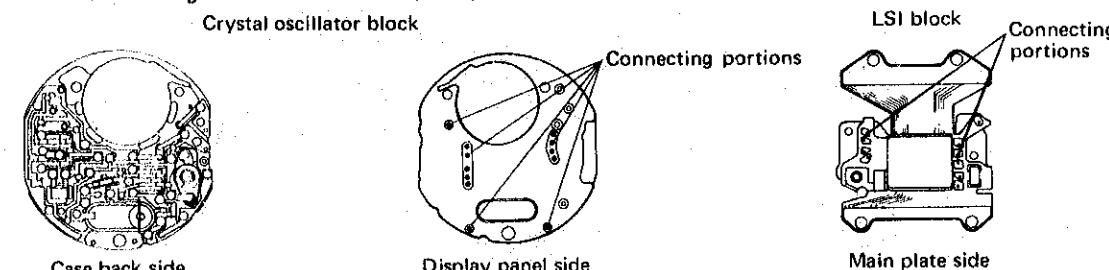
	Procedure	Result and repair
A CHECK BATTERY VOLTAGE	<p>Use the following procedures to check the battery voltage.</p> <p>(1) Set up the volt-ohm-meter. Range to be used: DC 3 V</p>  <p>(2) Measuring</p> <ul style="list-style-type: none"> Probe Red (+) Battery surface (+) Probe Black (-) Battery surface (-) 	<p>More than 1.5 V . . . Normal Less than 1.5 V . . . Defective</p>
CHECK PATTERN SEGMENT CHECKING SYSTEM	<p>If some segments are dead or dim, change the watch function into the time and calendar setting function. Then depress buttons A and B at the same time find to the defective segments. Refer to the illustration of the panel pattern on page 16. (If there is not defective segment, all segments light up.)</p> 	<p>Proceed to B</p>
HOW TO CHECK BATTERY ELECTROLYTE LEAKAGE AND REPAIR	<ol style="list-style-type: none"> Remove the movement from the case Disassemble the movement Wipe off battery electrolyte on the crystal oscillator block and the LSI block <ol style="list-style-type: none"> Wipe off battery electrolyte on the lead frame, each connecting portion, etc. with a cloth moistened with distilled water. (Do not use such fluffy cloth as gauze, flannel, etc.) When the crystal oscillator block and the LSI block are cleaned, be sure to clean the shaded portions shown below and the connecting portions. <p>Note: Do not expose the trimmer condenser to water or alcohol, and if it is exposed, there may be a change in its condenser capacity and eventually in the time accuracy.</p>  <p>Crystal oscillator block LSI block Connecting portions</p> Wipe the shaded portions and the connecting portions again with a cloth moistened with alcohol. (If the cleaned portions remain wet with water, they will corrode with rust.) Dry with cool air by using a dryer. Wipe off battery electrolyte on the other parts (main plate, switch components, etc.). <ol style="list-style-type: none"> Wipe off battery electrolyte on the each portion with a soft brush moistened with distilled water. (If distilled water is not available, use ordinary water.) Rinse with alcohol. Dry with cool air by using a dryer. Reassemble the movement Replace the battery with a new one. Check if the time setting functions and the current consumption are normal. 	

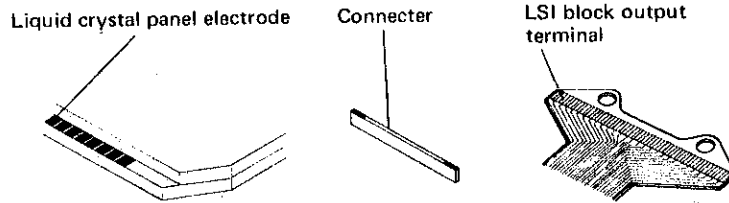
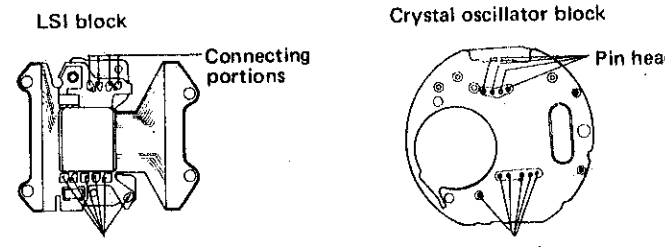
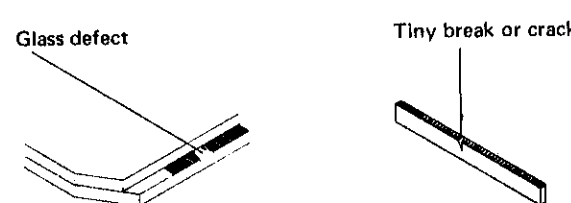
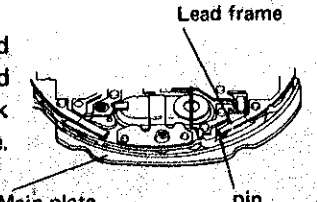
	Procedure	Result and Repair
B CHECK CONDUCTIVITY OF LIQUID CRYSTAL PANEL, LSI BLOCK AND CRYSTAL OSCILLATOR BLOCK	<p>(1) Make sure that the screws are tightened firmly.</p> <p>1. Crystal oscillator block screw (2 pcs.), circuit bridge plate screws (3 pcs.) 2. LSI block screws (3 pcs.)</p>  <p>(2) Check for dust, lint or other contamination on the conductive portions shown in the illustration below.</p>  <p>Liquid crystal panel electrode Connector LSI block output terminal</p>  <p>LSI block Connecting portions Crystal oscillator block Pin heads</p> <p>Connecting portions with the pin of the crystal oscillator block (10 portions) Check for dust, lint or other contamination on the pin heads.</p> <p>(3) Check the liquid crystal panel electrode for any glass defect and the connector for any tiny break</p>  <p>Glass defect Tiny break or crack</p> <p>(4) Remove the circuit bridge plate and check the connection of the lead frame of the crystal oscillator block with the pins by using a microphone.</p>  <p>Lead frame Main plate pin</p>	<p>No loosened screws . . . Normal Proceed to B₂</p> <p>Loosened screws Defective Retighten screws</p> <p>Uncontaminated . . . Normal Proceed to B₃</p> <p>Contaminated Defective Wipe off any foreign matter.</p> <p>No glass defects, break or crack Normal Proceed to B₄</p> <p>Glass defects, break or crack Defective Replace with new ones</p> <p>Lead frame Pin Normal Main plate If time is inaccurate, wear the watch on the wrist for test.</p> <p>. Defective Bend the lead frame with tweezers so that it touches the pin.</p>

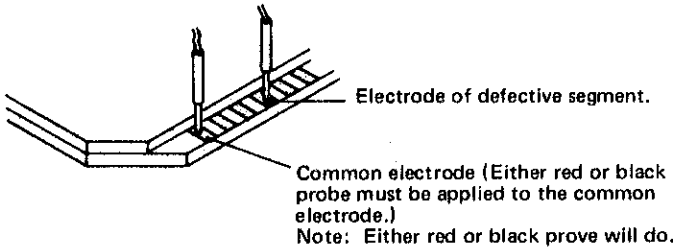
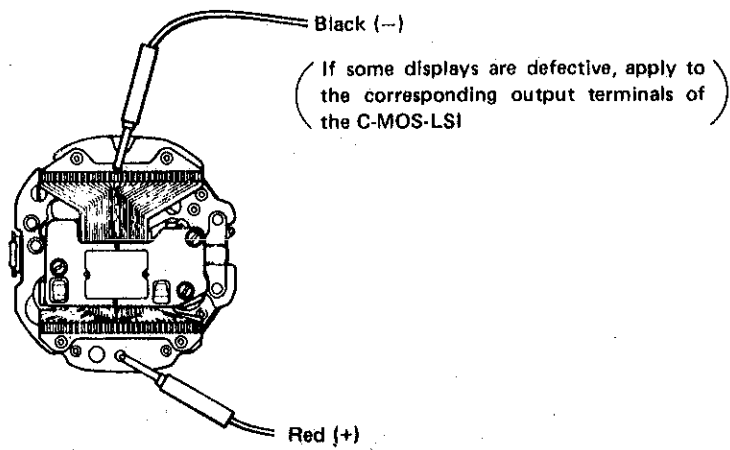
	Procedure	Result and repair
C	<p>Check to see if the liquid crystal panel, the LSI block and the crystal oscillator block function correctly. (Refer to "Relationship between the segment (Liquid Crystal Panel Electrode) and the C-MOS-LSI output terminal" on page 16.)</p> <p>(1) Check the liquid crystal panel</p> <p>1 Set up the volt-ohm-meter Range to be used: OHMS $R \times 1 \sim R \times 1 K$</p> <div style="border: 1px solid black; padding: 2px;"> <p><i>Note:</i> Any range will do if more than 3 V is applied to the terminal of the volt-ohm-meter. If the output voltage of the volt-ohm-meter is less than 3 V in measuring, segment may not be lit. When no segment is lit, change the range to $R \times 10 K$ which is higher in resistance than $R \times 1 K$.</p> </div> <p>2 Remove the liquid crystal panel from the movement and turn it upside down.</p> <p>3 Measuring</p>  <p style="font-size: small;">Electrode of defective segment. Common electrode (Either red or black probe must be applied to the common electrode.) Note: Either red or black probe will do.</p> <p>(2) Check the LSI block and crystal oscillator block output voltage.</p> <p>1 Set up the volt-ohm-meter. Range to be used: DC 3 V</p> <p>2 After reassembling the battery and the battery holding spring to the movement, remove all parts from liquid crystal panel holder screw ① to liquid crystal panel frame ⑦ on page 10.</p> <p>(3) Measuring Probe Red (+) Main plate Probe Black (-) One of the output terminals of the C-MOS-LSI</p>  <p style="font-size: small;">Black (-) Red (+) (If some displays are defective, apply to the corresponding output terminals of the C-MOS-LSI)</p>	<p>Lights up Normal Proceed to C₂</p> <p>Does not light up. . . Defective Proceed to Replace liquid crystal panel.</p> <p>More than 0.8 V . . . Normal (All the terminals must be more than 0.8 V.) Return to B</p> <p>Less than 0.8 V . . . Defective</p> <p>Replace the LSI block or the crystal oscillator block with a new one and check to see if it functions correctly. (This will tell which block is defective.)</p>

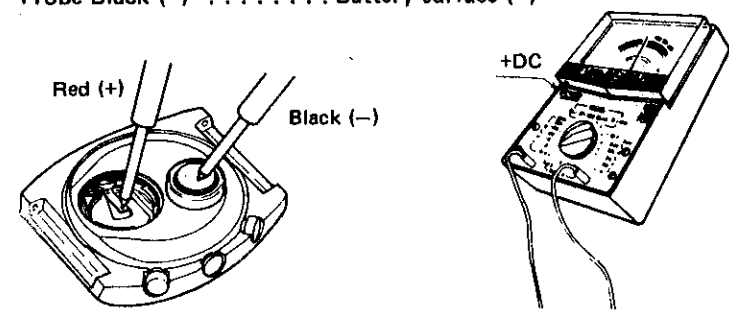
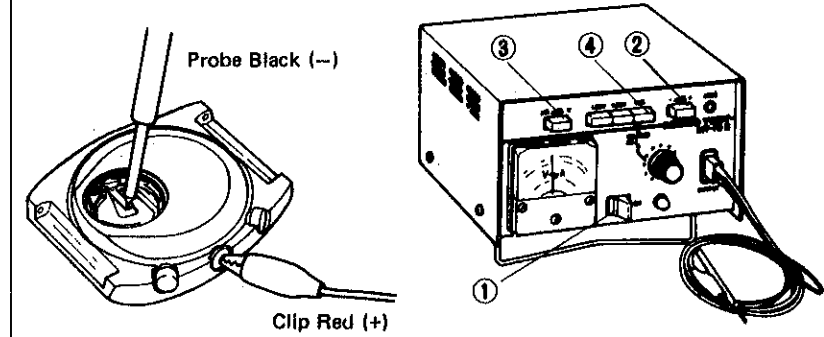
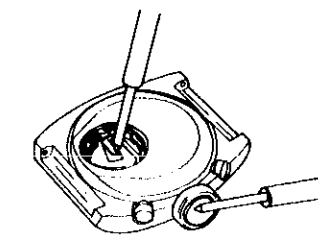
	Procedure	Result and repair
D	<p>Check to see if the current consumption is normal. (Checked both in the time function and the time and calendar setting function.)</p> <p>Measuring</p> <p>(1) Volt-ohm-meter Range to be used: DC 0.03 mA* Probe Red (+) Battery connection Probe Black (-) Battery surface (-)</p>  <p style="font-size: small;">Red (+) Black (-) +DC</p> <p><i>Note:</i> If it is impossible to measure (Current does not flow from the case to the movement), touch the battery surface (+) to stem with button C (or button B) for measuring.</p> <p>Reasons:</p> <ul style="list-style-type: none"> • Button is electrically connected to (+). • When the battery surface (+) is touched to button A, the light is lit and the current consumption increases greatly. <p>(2) Micro Test Set up the Micro Test</p> <p>1 Power switch ON 2 Polarity changeover button + 3 Current consumption/Voltage indication button . . . μA 4 Voltage selection button 1.55 V Clip Clip Red (+) Stem with button C (or button B) Probe Black (-) Battery connection</p>  <p style="font-size: small;">Probe Black (-) Clip Red (+)</p>	<p>* <i>Note:</i> If the pointer of the volt-ohm-meter swings over the maximum value when DC 0.03 mA is used, change the range to a greater one where the pointer does not run over the maximum value while applying the probes to the respective portions. Then, after two or three seconds, return the range to DC 0.03 mA again for measuring.</p>  <p>Less than $3.5 \mu A$. . . Normal Proceed to Replace with a provisional battery.</p> <p>More than $3.5 \mu A$. . . Defective Proceed to C</p>

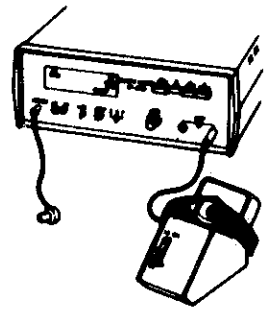
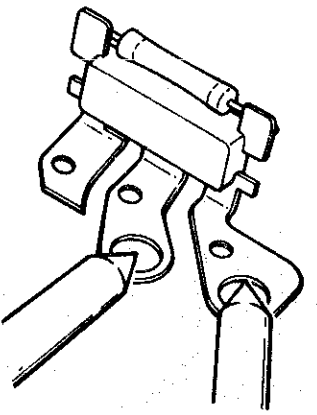
	Procedure	Result and repair
CHECK ACCURACY	<p>Check gain and loss of time.</p> <p>(1) Set up the Quartz Tester. As there are several different types of Quartz Testers, refer to a respective instruction manual.</p> <p>(2) Measuring</p> 	<p>Neither gain nor lose Normal</p> <p>Either gain or lose Defective</p> <p>Proceed to Time accuracy adjusting. See page 23 for reference.</p>
CHECK ADJUSTMENT AND FUNCTIONING	<p>Check to see if all the digit adjustments can be made at this time by the button operation by following the procedures on page 3. Check adjustments for more than one cycle.</p>	<p>Can be adjusted or functions correctly . . Normal Proceed to H</p> <p>Cannot be adjusted or does not function . . Defective Replace the LSI block or the crystal oscillator block with a new one.</p>
CHECK BULB CONDITION	<p>Check to see if the bulb functions correctly.</p> <p>(1) Check to see if there are any loosened bulb holder screws (2 pcs.).</p> <p>(2) Check by using the volt-ohm-meter.</p> <p>1 Remove the bulb from the crystal oscillator block.</p> <p>2 Set up the volt-ohm-meter Range to be used: OHMS R x 1</p> <p>3 Measuring</p> <p>Check to see if there is a broken filament in the bulb and if there is any break in the welded portion of the terminal.</p> <p>Probe Red (+) Apply to the lead terminals.</p> <p>Probe Black (-) (Either side of the bulb lead terminal will do.)</p> 	<p>No loosened screw . . Normal Proceed to C₂.</p> <p>Loosened screw . . Defective Replace bulb with a new one.</p> <p>Lights up Normal Proceed to H</p> <p>Does not light up Defective Replace bulb with a new one.</p>

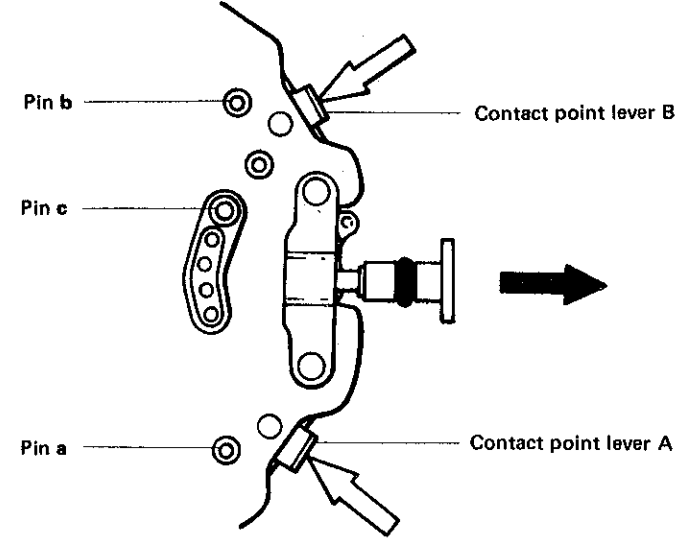
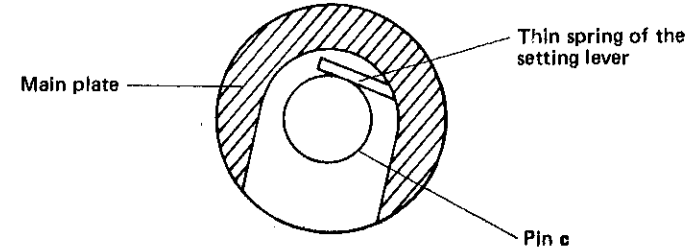
	Procedure	Result and repair
CHECK CONDUCTIVITY OF SWITCH COMPONENTS	<p>Check to see if the switch components function correctly. Check by using a microscope after disassembling procedures have been completed up to the LSI block 9 on page 10.</p>  <p>(1) Check functioning of the contact point levers A and B. Check to see if the thin springs of the contact point levers A and B touch the pins (a) and (b) when the arrow-marked portions of the contact levers A and B are depressed by tweezers and if they do not touch the pins (a) and (b) when the arrow-marked portions of the contact point levers A and B are released.</p> <p>(2) Check functioning of the setting lever. Check to see if the thin spring of the setting lever touches the pin (c) when the stem with button C is pulled out and if it does not touch the pin (c) when stem with button C is depressed.</p>  <p>(3) Check for dust, lint or other contamination on the conductive portions of the above parts.</p>	<p>Function correctly Normal Proceed to H₂.</p> <p>Does not function correctly Defective Adjust the contact point levers. (If adjustment is impossible, replace the contact point levers with new ones.)</p> <p>Functions correctly Normal Proceed to H₃.</p> <p>Does not function correctly Defective Adjust the thin spring. (If adjustment is impossible, replace the setting lever with a new one.)</p> <p>Uncontaminated . . . Normal Proceed to B.</p> <p>Contaminated . . . Defective Wipe off any foreign matter.</p>

TIME ACCURACY ADJUSTING

Time accuracy of Cal. M154A is adjusted by turning the trimmer condenser.

- **Adjusting method**

The watch will gain or lose according to the direction in which the trimmer condenser is turned. Adjustment should therefore be made after ascertaining with the Quartz Tester whether the watch tends to gain or lose.

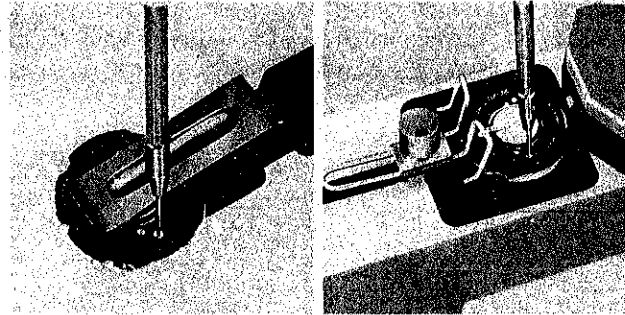

- **Note for handling the trimmer condenser**

Avoid excessive depressing and turning of the trimmer condenser.

- **Function of the Trimmer Condenser**

The trimmer condenser consists of a rotor electrode and a stator electrode as shown in the diagram. Turning the shaft fixed to the rotor changes the overlapped area between the stator electrode and rotor electrode, which in turn changes the capacity of the trimmer condenser.

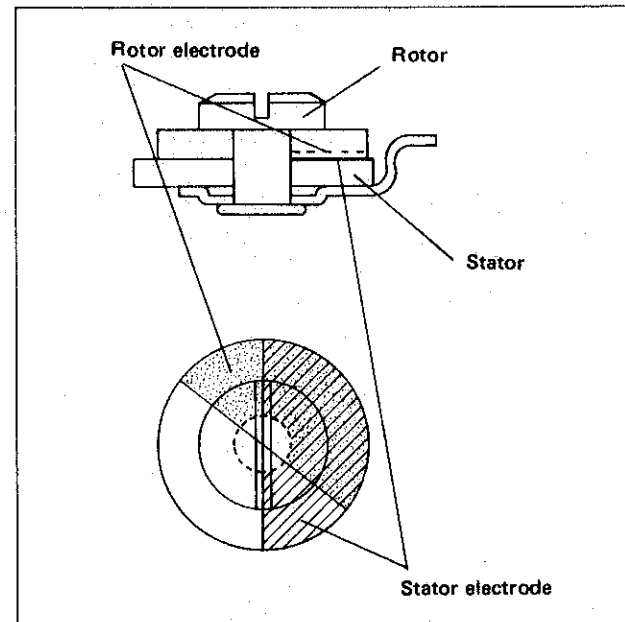

- **Change in the capacity of trimmer condenser and the adjusting accuracy rate.**

Turning the trimmer condenser changes its capacity as shown in the diagram.

The trimmer condenser has been so adjusted at the factory so as to let the watch gain when it is turned clockwise and vice versa. Whenever adjustment is needed, however, turn the trimmer condenser while examining the gain and loss by the Quartz Tester.

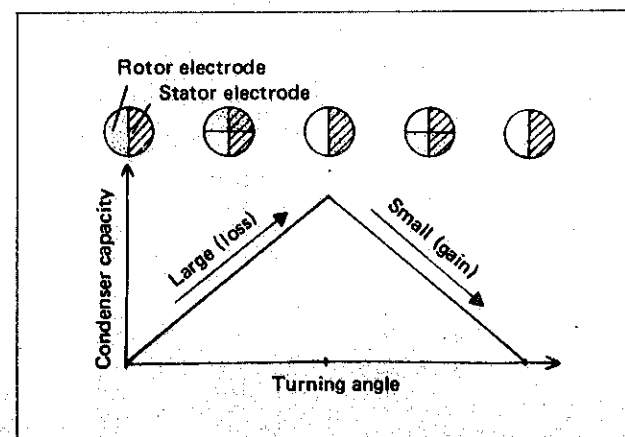

All procedures of Disassembling and Reassembling, and Checking and Adjustment are completed.