

# **TECHNICAL GUIDE AND PARTS LIST**

CAL. W041A

## **DIGITAL QUARTZ**

---

### **CONTENTS**

---

I. SPECIFICATIONS .....	1
II. DISASSEMBLING, REASSEMBLING AND LUBRICATING OF THE CASE.....	2
III. DISASSEMBLING, REASSEMBLING OF THE MODULE.....	3
IV. CHECKING AND ADJUSTMENT .....	4
V. PARTS LIST.....	5

## I. SPECIFICATIONS

Item	Cal. No.	W041A
Display medium		Nematic Liquid Crystal, FEM (Field Effect Mode)
Liquid Crystal Driving System		Multiplex driving system
Display system		<ul style="list-style-type: none"> <li>● Time and calendar display (12-hour/24-hour indication)</li> <li>● Alarm display (alarm time: 20 seconds)</li> <li>● Stopwatch display (up to 12 hours)</li> <li>● Timer display (up to 11 hours and 59 minutes)</li> <li>● Dual time display</li> </ul>
Additional mechanism		<ul style="list-style-type: none"> <li>● Hourly time signal</li> <li>● Alarm test system</li> <li>● Illuminating light</li> <li>● Full auto calendar</li> </ul>
Loss/gain		Monthly Rate: Less than 20 seconds at normal temperature range
Module size	Casing diameter	φ29.3 mm (6 – 12H: 26.0 mm/3 – 9H: 26,0 mm)
	Height	5.7 mm
Regulation system		Trimmer condenser
Quartz Tester measuring gate		Any gate is available
Battery		<ul style="list-style-type: none"> <li>● SEIKO CR2025</li> <li>Battery life: Approx. 10 years</li> <li>Voltage: 3.0V</li> </ul>

### NOTE :



On the following pages, only the specific items of the Cal. W041A is described. For THE STRUCTURE OF CIRCUIT BLOCK, OPERATION, and CHECKING AND ADJUSTMENT, refer to Cal. W040A Technical Guide.

## II. DISASSEMBLING, REASSEMBLING AND LUBRICATING OF THE CASE

Disassembling procedures: Figs. ① ~ ③

Reassembling procedures: Figs. ③ ~ ①

Lubricating:

Types of oil	Oil quantity
Silicon oil 	Standard 

### ● How to remove/install push buttons

Don't remove the buttons except when the button does not function correctly due to dust or lint.

(Removal)

While holding the button retaining ring with tweezers, push it outward.

\* Do not disassemble the button retaining ring.

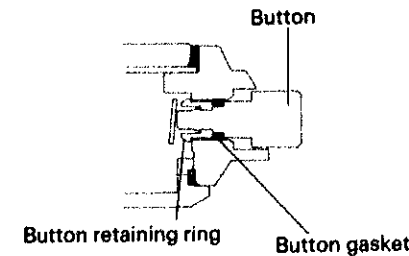

(Installation)

Press in the button to the case.

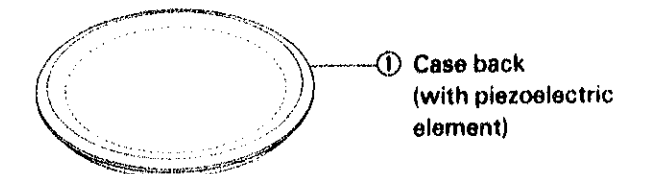

① Case back  
(with piezoelectric element)



② Case back gasket

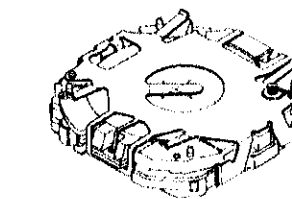

③ Module  
Buzzer lead terminal

\* Take care not to lose it.

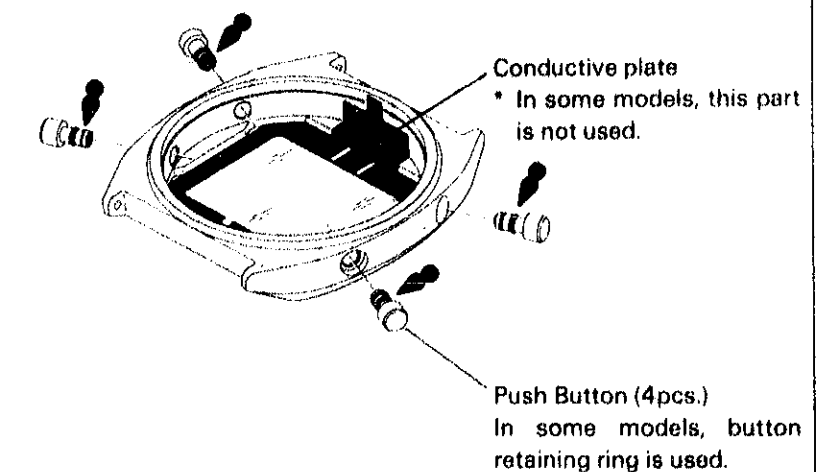

Conductive plate  
\* In some models, this part is not used.

Push Button (4pcs.)  
In some models, button retaining ring is used.

### III. DISASSEMBLING AND REASSEMBLING OF THE MODULE





Disassembling procedures: Figs. ① ~ ⑪

Reassembling procedures: Figs. ⑪ ~ ①

#### ① Buzzer lead terminal

To remove the buzzer lead terminal, turn it to align the tip with notch in the battery guard.

\* Two types of buzzer lead terminals are used according to the construction of the case back as follows.

Construction of the case back	Mounting direction	
	Case back side	Circuit side
Screw type		
	4246 042	
Other than screw type		
	Either is possible 4246 041	

#### ② Battery clamp

(Removal)

Insert the tweezers into the battery clamp at 6 o'clock position as shown in the right figure and pry it out.

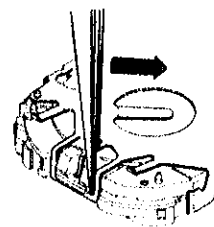

(Installation)

Set the battery clamp at 12 o'clock position first, then set the 6 o'clock position.

#### ④ Battery guard

The battery guard is fixed with 4 guide pins on the liquid crystal panel frame.

(Removal)

Insert a screw driver between the circuit block and battery guard near the guide pin and repeatedly pry out.

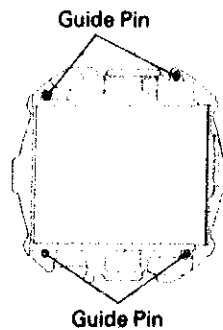

(Installation)

Uniformly press in the battery guard so that there is no gap between the circuit block, liquid crystal panel frame and battery guard.

#### ⑦ Anti-static electricity plate

Set the anti-static electricity plate in the guide pin of the liquid crystal panel frame.

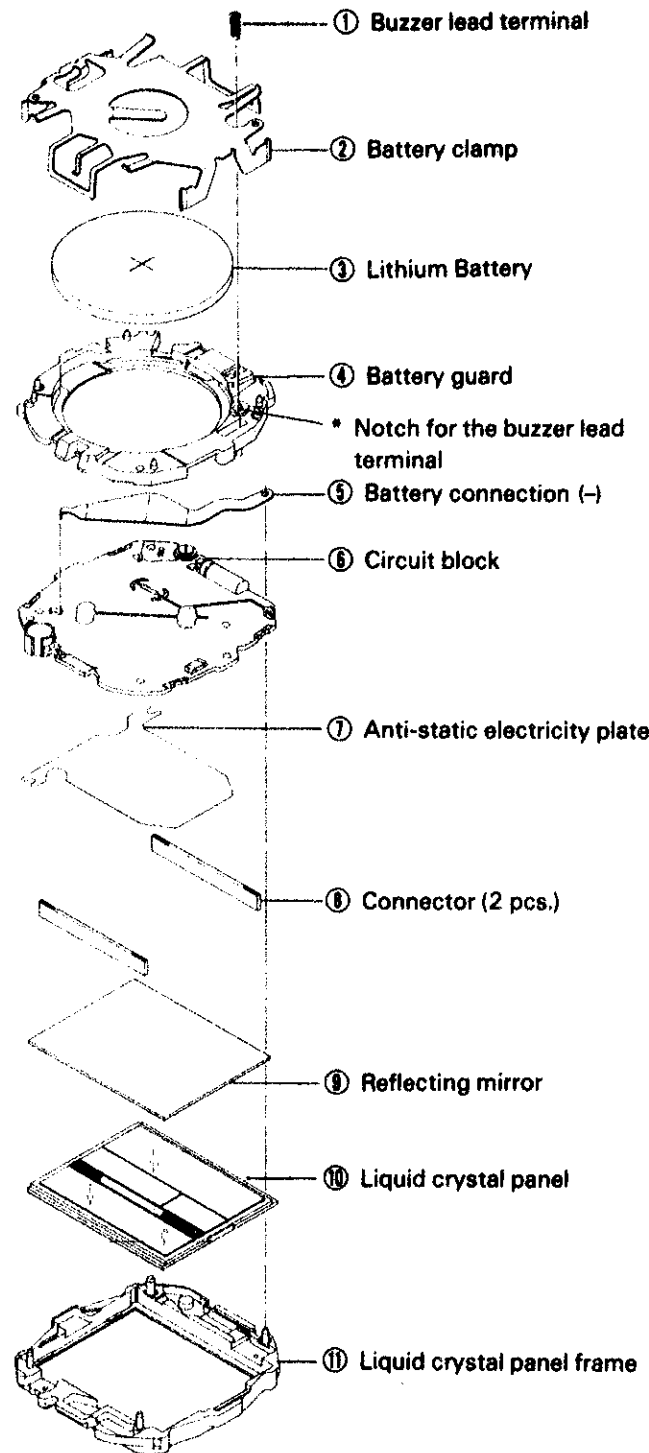

### IV. CHECKING AND ADJUSTMENT

#### CURRENT CONSUMPTION

Use the SEIKO Digital Multi Tester S-840A and the Multi Adaptor MA-40 with Lithium battery (CR2025).

Range to be used:  $\mu\text{A}$

① Check the current consumption for the whole of the module.

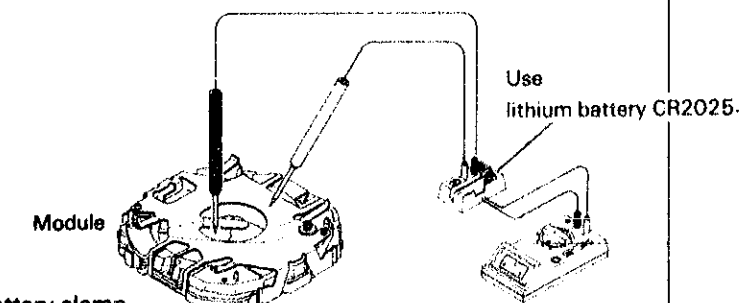

Red Probe: Battery clamp  
Black probe: Battery connection  $\ominus$

Result:  
More than  $1.4\mu\text{A}$ : Defective  
Less than  $1.4\mu\text{A}$ : Normal

② If the current consumption is more than  $1.4\mu\text{A}$ , check the current consumption for the circuit block alone.

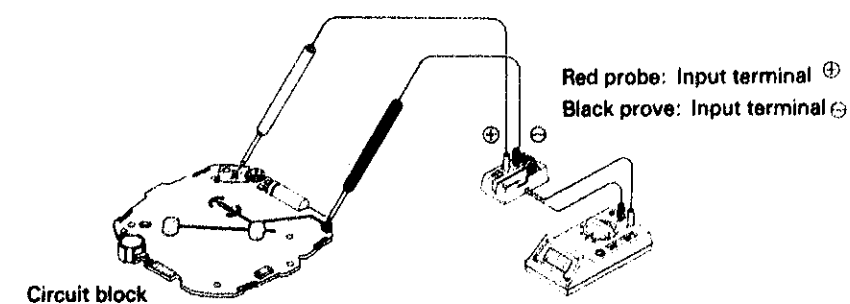

Red probe: Input terminal  $\oplus$   
Black probe: Input terminal  $\ominus$

Result:  
Less than  $0.8\mu\text{A}$ : Normal  
More than  $0.8\mu\text{A}$ : Defective  
Replace the circuit block.

**V. PARTS LIST**

<b>Cal. W041 A</b>	
PARTS NO.	PARTS NAME
4000 067	Circuit block
4225 070	Battery clamp
4248 041	Buzzer lead terminal
4248 042	Buzzer lead terminal (for screw typed case back)
4257 012	Anti-static electricity plate
4270 066	Battery connection (-)
4313 056	Connector
4395 022	Battery guard
*4510 039	Liquid crystal panel (Gold)
*4510 095	Liquid crystal panel (Silver)
4512 002	Liquid crystal panel frame
4521 030	Reflecting mirror
4530 230	Bulb
4589 003	Piezoelectric element
SEIKO CR2025	Lithium battery

**Remarks:**

\* Liquid crystal panel  
 4510 039 (Gold) } ..... Be sure that combination between the color of panel cover and liquid  
 4510 095 (Silver) } ..... crystal panel should be matched according to the "Casing Parts Catalogue".