

IDENTIFICATION OF CHRONOGRAPH

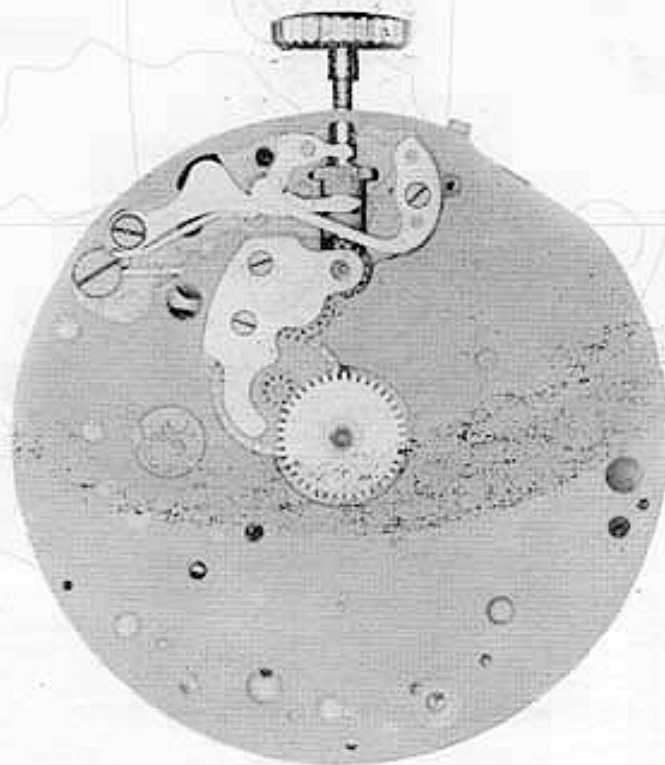

13L.



VALJOUX

CAL. 23

INSTRUCTIONS

For use of book

DISASSEMBLY OF THE CHRONOGRAPH MECHANISM:

1. Study the isometric drawing at top of page 1-A. The isometric drawing was made for the following purposes:
 - A. It helps to identify the part to be removed.
 - B. This drawing aids in pointing out certain locations on the part that are mentioned in the oiling procedure.
 - C. The text refers to certain points on the part. These points are shown in the isometric drawing. This should aid you in finding the exact location on the part that is described in the text.
 - D. It helps you to know the shape of the part in case a new part has to be made.
2. At the bottom of the page 1-A is a photograph of a chronograph. In this photograph is the same part painted in black. The part is in its exact location that this part occupies in the watch. Find this location in the watch.
3. Read the disassembly procedure and the hazards in disassembly on page 1 in this book.
4. Remove this part in the same procedure as described in the text.
5. A very important item in disassembling a chronograph is keeping the screws in order, much time will be lost in putting the chronograph together if screws are mixed up. This means you have to hunt for each screw, sometimes trying three or four screws before finding the correct one. It cannot be stressed too strongly that care should be taken so that screws are not mixed up. The system that we advise for beginners, is to replace each individual screw after each part is removed. This naturally eliminates the hazard of mixing up the screws and will save you much time in the end. Do this at least until you become so thoroughly familiar with the chronograph that you no longer feel it is necessary.
6. Continue to follow this procedure throughout the book and disassemble each part until the last part of the chronograph is removed.

ASSEMBLY OF THE CHRONOGRAPH MECHANISM:

7. When you are ready to assemble the chronograph mechanism, study the isometric drawing on the last part in this book. This drawing should aid you in identifying the part to be assembled.
8. At the bottom of this page is a photograph of a chronograph. In this photograph is the same part painted in black. The part is in its exact location that this part occupies in the watch.
9. Read the assembly procedure and the hazards in assembling for the last part in this book. (Continued on next page)

INSTRUCTIONS (Continued)

10. Replace the part in its exact location as shown in photograph, using the procedure as described in the text.

11. After you find the correct location for this part in the watch, read the oiling procedure for this part. The oiling procedure for this part is located underneath the isometric drawing. It is best to read the oiling procedure before you put each part in place as there are certain parts that must be oiled immediately as it may prove difficult to oil them later.

12. Replace the screw that holds this part in place. Of course, the screws should be kept in order as we advised above, but if the screws are not in order or the watch was received with screws mixed up, you will find a screw drawn for each part that requires a screw at the bottom of the text page.

13. After replacing this part, replace the next part, etc., until the last part is replaced, which will be part No. 1. Each part should be replaced using the same procedure as described in the text.

(Naturally, the assembly of the chronograph is exactly the reverse of the disassembly)

14. After disassembling and assembling the chronograph mechanism, start on page 1 and read the function of this part. After reading the function of this part, continue to read the function of each part throughout the book. Study each part, one at a time. This text should help you to understand more fully the purpose of each part in the chronograph mechanism.

15. Now put movement in its case with dial on, then replace hands.

16. Study the text on functional results in this book, and check the chronograph mechanism as described in this text.

NOMENCLATURE OF PART FOR CHRONOGRAPH MECHANISM













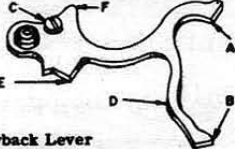

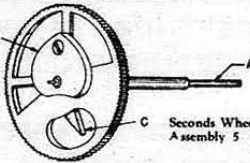

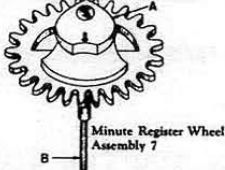

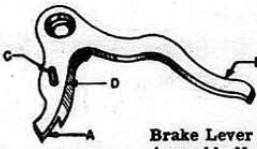

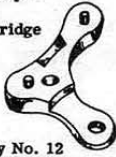
17. After you have become familiar with the chronograph mechanism, you can disassemble and assemble the chronograph by using the nomenclature of parts as a guide. This makes it possible for you to use a procedure without going through each page in the book.

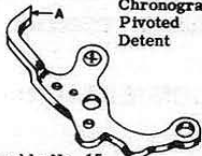
18. ADJUSTMENT OF ECCENTRIC STUDS:

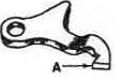
Read the text on adjustment of eccentric studs, this text should be read in reference to the eccentric stud picture. Now adjust each eccentric stud one at a time in the watch, as described in the text. Use the picture to show you the position of these studs.

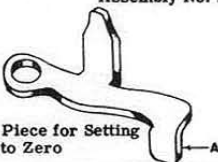
19. On each page in this book the part number and the page number are the same. This makes it convenient for the reader and eliminates any confusion.

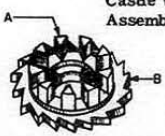
NOMENCLATURE OF PARTS FOR CHRONOGRAPH MECHANISM

 Wheel over Fourth Wheel Assembly No. 1	 Flyback Lever Spring Assembly No. 2	 Flyback Lever Assembly No. 3
 Seconds Wheel Minute Register Wheel Bridge Assembly No. 4	 Seconds Wheel Assembly 5	 Seconds Wheel Tension Spring Assembly No. 6
 Minute Register Wheel Assembly 7	 Minute Register Pawl Assembly No. 8	 Brake Lever Assembly No. 9
 Intermittent Lever Spring Assembly No. 10	 Intermittent Lever and Wheel Assembly No. 11	 Chronograph Pivoted Detent Bridge Assembly No. 12
 Intermediary Wheel Assembly No. 13	 Chronograph Pivoted Detent Spring Assembly No. 14	 Chronograph Pivoted Detent Assembly No. 15
 Brake Lever Spring Assembly No. 16	 Actuating Detent Lever Spring Assembly No. 17	 Joint Hook Assembly No. 18
 Actuating Detent Lever Assembly No. 19	 Push Piece for Setting Back to Zero Assembly No. 20	 Castle Wheel Pawl Assembly No. 21
 Castle Wheel Assembly 22	 Minute Register Hand	 Seconds Hand

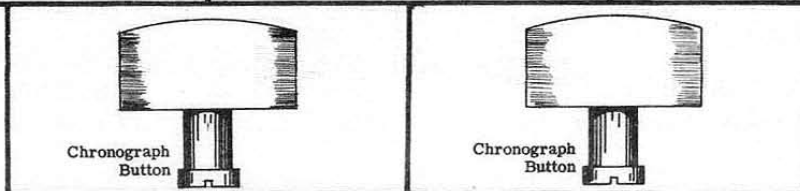

ADJUSTING ECCENTRIC STUDS -- THINGS TO CHECK

LISTED BELOW ARE A NUMBER OF DEPTHINGS AND ADJUSTMENTS CONTROLLED BY THE ECCENTRIC STUDS.

1. CHECK DEPTHING OF WHEEL OVER FOURTH WHEEL TEETH WITH THE INTERMEDIARY WHEEL TEETH.

CORRECTION: IF THIS DEPTHING IS INCORRECT, YOU CAN CORRECT IT BY ADJUSTING ECCENTRIC STUD ES-1.

REFERENCE: WHEEL OVER FOURTH WHEEL IS ASSEMBLY 1.
INTERMEDIARY WHEEL IS ASSEMBLY 13.

2. CHECK DEPTHING OF SECONDS WHEEL TEETH AND INTERMEDIARY WHEEL TEETH.

CORRECTION: IF THIS DEPTHING IS INCORRECT, YOU CAN CORRECT IT BY ADJUSTING ECCENTRIC STUD ES-2 AND ES-1.

REFERENCE: SECONDS WHEEL IS ASSEMBLY 5.
INTERMEDIARY WHEEL IS ASSEMBLY 13.

3. CHECK DEPTHING OF INTERMITTENT WHEEL TEETH AND SECONDS WHEEL DART TOOTH.

CORRECTION: IF THIS DEPTHING IS INCORRECT, YOU CAN CORRECT IT BY ADJUSTING ECCENTRIC STUD ES-3.

REFERENCE: SECONDS WHEEL DART TOOTH IS ASSEMBLY 5C.
INTERMITTENT WHEEL IS ASSEMBLY 11A.

ADJUSTING ECCENTRIC STUDS

DO NOT REMOVE THESE STUDS

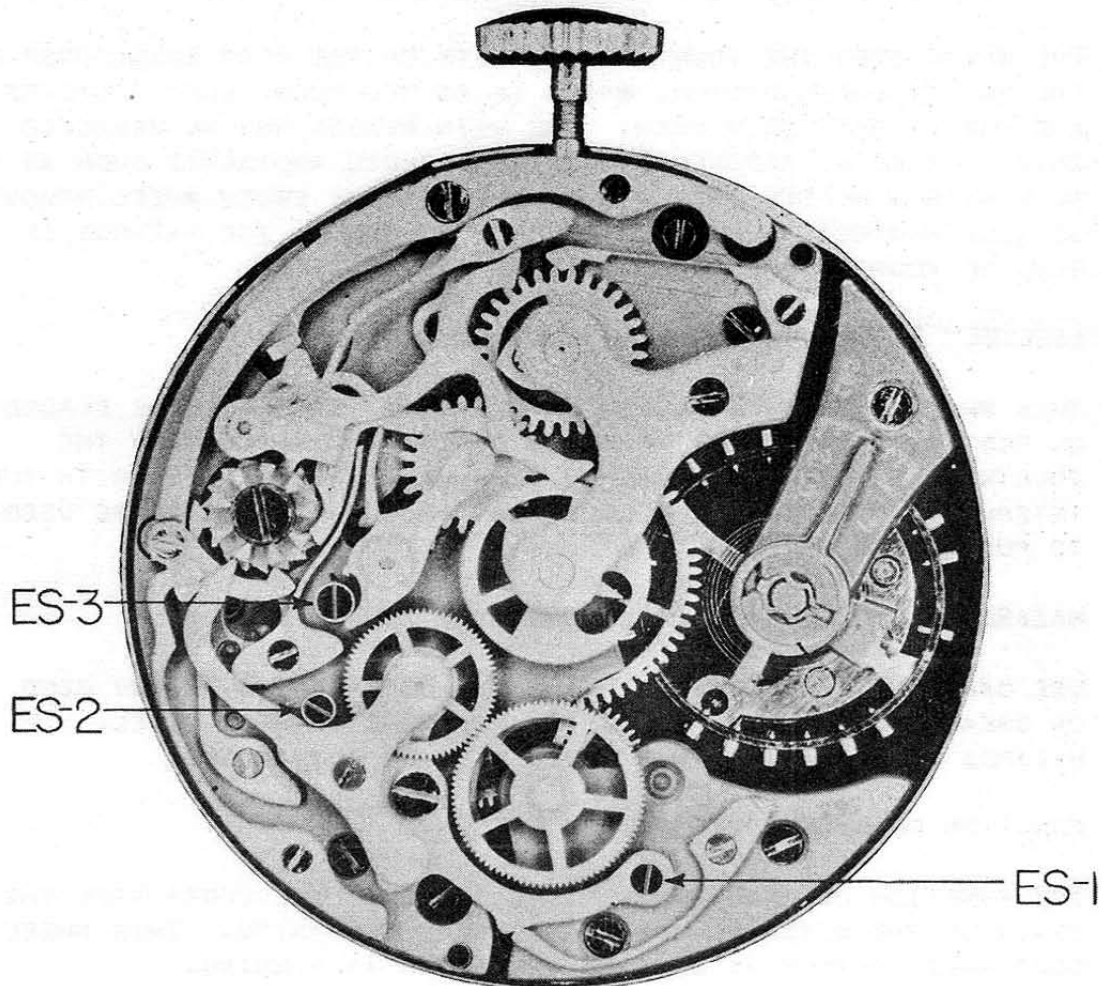

CAUTION

In disassembling or assembling chronograph it is a good policy not to turn eccentric studs. These eccentric studs are used to adjust one part to another and naturally in turning these studs you will lose the desired adjustment of the chronograph mechanism which will cause the chronograph to function incorrectly. Another reason for not turning these studs unless it is necessary is that they soon become loose and will not hold the desired adjustment.

PART NO. 1

A. DISASSEMBLY PROCEDURE OF WHEEL OVER FOURTH WHEEL:

THE WHEEL OVER THE FOURTH WHEEL FITS FRICTION TIGHT ON POST OF FOURTH WHEEL PINION. THIS WHEEL SHOULD BE REMOVED WITH A SWEEP WHEEL REMOVER, BUT CAN BE REMOVED WITH TWO SMALL THIN EDGE SCREWDRIVERS. THE SCREWDRIVERS ARE PLACED OPPOSITE EACH OTHER UNDER HUB OF WHEEL. ONE SCREWDRIVER IS TURNED CLOCKWISE WHILE THE OTHER SCREWDRIVER IS TURNED COUNTER-CLOCKWISE.

B. HAZARDS IN DISASSEMBLY OF WHEEL OVER FOURTH WHEEL:

THE WHEEL OVER THE FOURTH WHEEL FITS ON THE VERY SMALL POST OF THE FOURTH WHEEL PINION, WHICH IS AS YOU KNOW, VERY DELICATE AND EASILY BENT OR BROKEN. THE MAIN REASON WHY WE SELECTED THIS PART TO BE REMOVED FIRST IS TO AVOID ACCIDENTS SUCH AS A SLIP WITH A SCREWDRIVER AND SO ON. IF THE SWEEP WHEEL REMOVER IS HELD PERFECTLY UPRIGHT IN REMOVING WHEEL, THE HAZARDS OF BENDING FOURTH WHEEL POST WILL BE ELIMINATED.

C. ASSEMBLY PROCEDURE OF WHEEL OVER FOURTH WHEEL:

THIS WHEEL FITS OVER FOURTH WHEEL POST. IT SHOULD BE PLACED ON POST WITH THE HUB A OF WHEEL DOWN. THE WHEEL OVER THE FOURTH WHEEL SHOULD BE PUSHED DOWN UNTIL IT IS LEVEL WITH THE INTERMEDIARY WHEEL. A HOLLOW FLAT FACE PUNCH SHOULD BE USED TO PUSH WHEEL DOWN.

D. HAZARDS IN ASSEMBLING WHEEL OVER THE FOURTH WHEEL:

USE CARE IN STAKING DOWN THIS WHEEL SO THAT YOU DO NOT BEND OR BREAK FOURTH WHEEL POST. IF MOVEMENT IS HELD LEVEL, HAZARDS OF REPLACING THIS WHEEL WILL BE ELIMINATED.

E. FUNCTION OF WHEEL OVER FOURTH WHEEL:

THE FUNCTION OF THIS WHEEL IS TO TRANSMIT THE POWER FROM THE TRAIN OF THE WATCH TO THE CHRONOGRAPH MECHANISM. THIS WHEEL CONTINUES TO TURN AS LONG AS THE WATCH IS RUNNING.

F. REMARKS:

MECHANICALLY WE SHOULD REGARD THIS WHEEL AS THE INTERMEDIATE CHRONOGRAPH WHEEL, AS IT IS THE MAIN WHEEL WHICH TRANSFERS THE POWER FROM MOVEMENT TRAIN TO THE CHRONOGRAPH MECHANISM. THE SWISS TERM FOR THIS PART IS WHEEL OVER FOURTH WHEEL AND WE WILL USE THIS TERM TO DESCRIBE THIS WHEEL IN THIS TEXT.

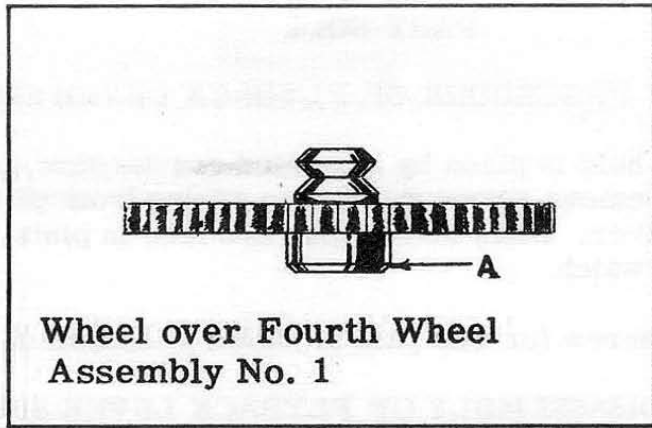

OILING

The wheel over the fourth wheel should not be oiled.

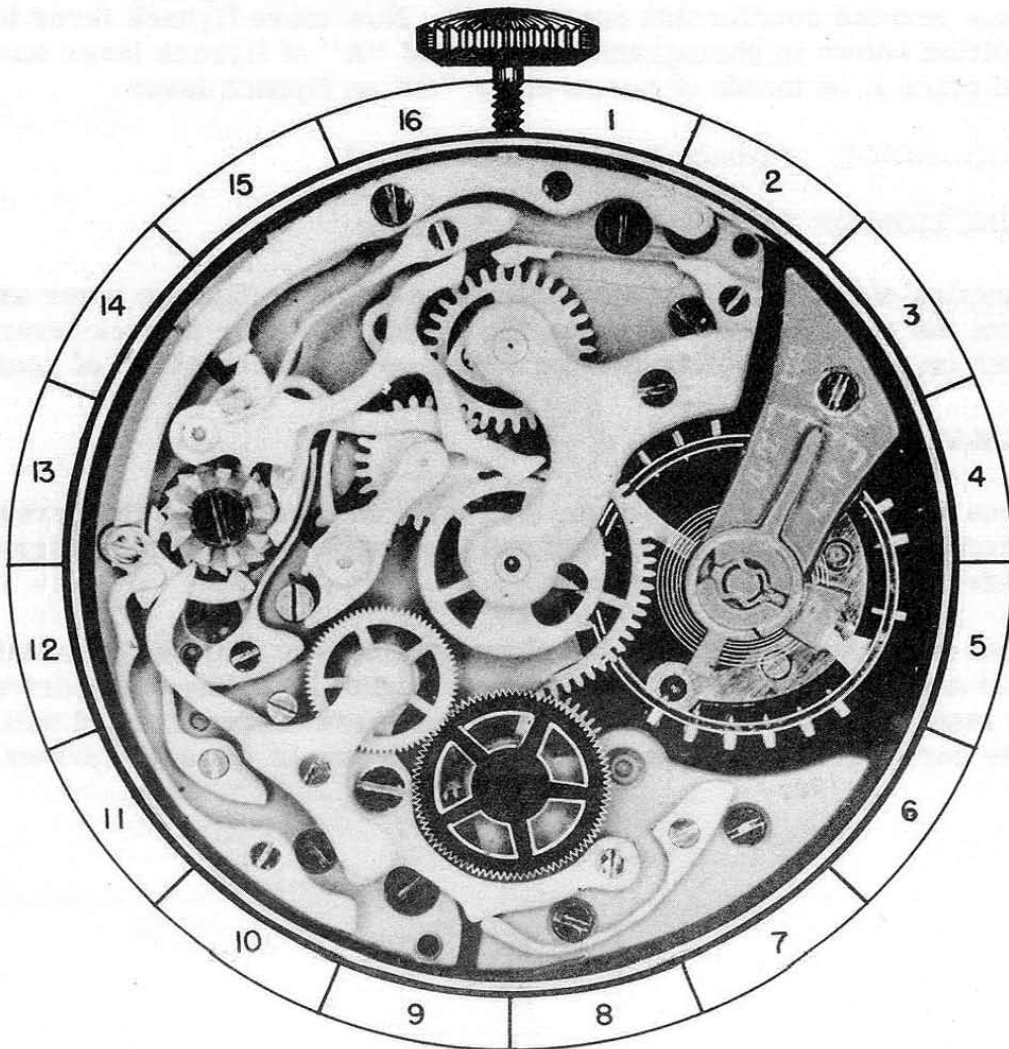

1 - A

PART NO. 2

A. DISASSEMBLY PROCEDURE OF FLYBACK LEVER SPRING:

This spring is held in place by a beveled countersink screw BS-1 and steady pins. Remove screw and loosen spring from plate with a thin blade screwdriver. When steady pins are free in plate, spring may be removed from watch.

(The shape of screw for this part is shown at bottom of page.)

B. HAZARDS IN DISASSEMBLY OF FLYBACK LEVER SPRING:

Screwdriver should be carefully used when loosening bridge from plate to prevent marring of plate or spring.

C. ASSEMBLY PROCEDURE OF FLYBACK LEVER SPRING:

To replace this spring, first move the flyback lever in toward center of watch. Then place spring on plate with the steady pins over proper holes in plate. Press spring down to proper place on plate and re-place beveled countersink screw BS-1. Now move flyback lever to position shown in photograph and lift end "A" of flyback lever spring and place it on inside of screw-head "C" on flyback lever.

REFERENCE: Flyback lever is Assembly 3.

D. FUNCTION OF FLYBACK LEVER SPRING:

Function of the flyback lever spring is to hold the flyback lever away from the center of watch. Also, the spring holds the flyback lever down on post, preventing it from riding up and coming free of post.

REMARKS:

When repairing a chronograph, it is most important that the screwdrivers are properly sharpened and the correct size of screwdriver blade used for each screw slot.

Most of the screws used in the chronograph have a highly polished head and are very easily marred by a slight slip of the screwdriver. To repair a chronograph and have these screw-heads marred will indicate carelessness, either in sharpening or use of the screwdriver.

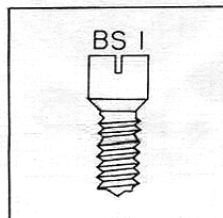

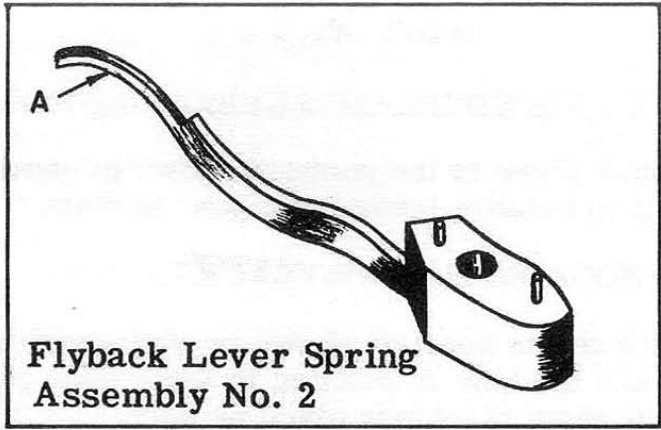

Flyback Lever Spring
Assembly No. 2

OILING

The A end of the flyback lever spring should be slightly moistened with oil at the point it contacts flyback lever.

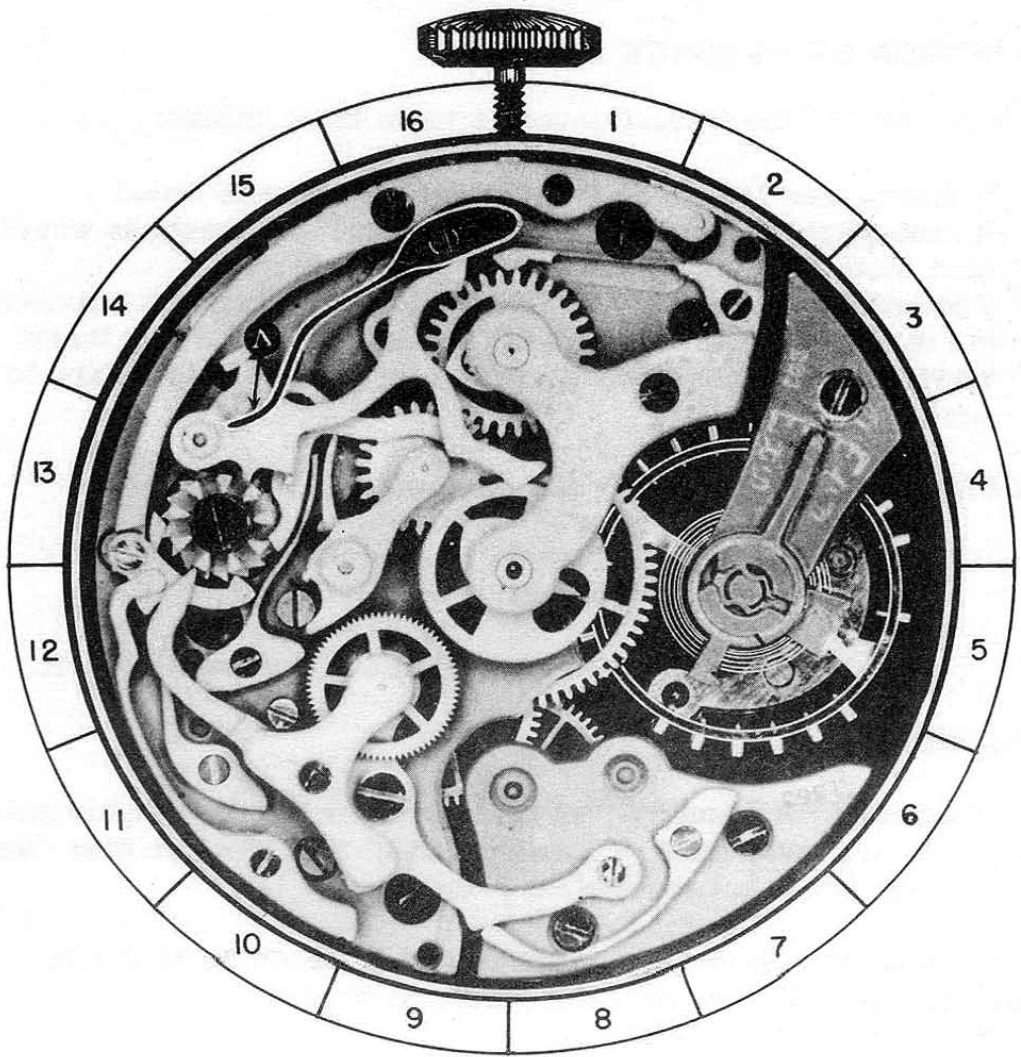

2 - A

PART NO. 3

A. DISASSEMBLY PROCEDURE OF FLYBACK LEVER:

Move the flyback lever to the position shown in photograph. Then lift straight up to remove lever from post in plate.

B. ASSEMBLY PROCEDURE OF FLYBACK LEVER:

Place flyback lever in position shown in photograph with the screw-head "C" up and the hole in bushing in lever over post in plate. Now push lever down to proper place on post.

C. HAZARDS IN ASSEMBLY OF FLYBACK LEVER:

When pressing flyback lever down in position, be sure that end "B" of lever does not catch on seconds wheel and minute register wheel bridge, as this may cause damage to the flyback lever.

REFERENCE: Seconds wheel and minute register wheel bridge is Assembly 4.

D. FUNCTION OF FLYBACK LEVER:

The function of the flyback lever is to do three things:

1. It disengages the brake lever from the seconds wheel.
2. It disengages the intermittent wheel from the seconds wheel dart tooth.
3. The ends "A" and "B" of flyback lever contact the hearts on the minute register wheel and seconds wheel forcing these wheels and the hands connected to these wheels to return to a zero position.

REFERENCE: Brake lever is Assembly 9.
Seconds wheel is Assembly 5.
Intermittent wheel is Assembly 11-A.
Seconds wheel dart tooth is Assembly 5-C.
Seconds wheel heart is Assembly 5-B.
Minute register wheel heart is Assembly 7-A.

REMARKS:

The flat ends "A" and "B" of flyback lever must be highly polished, as any roughness or pits of rust at this location may cause the flyback lever not to function properly.

When polishing these ends, care should be taken so as not to shorten one end more than the other, or they will not function correctly as described above.

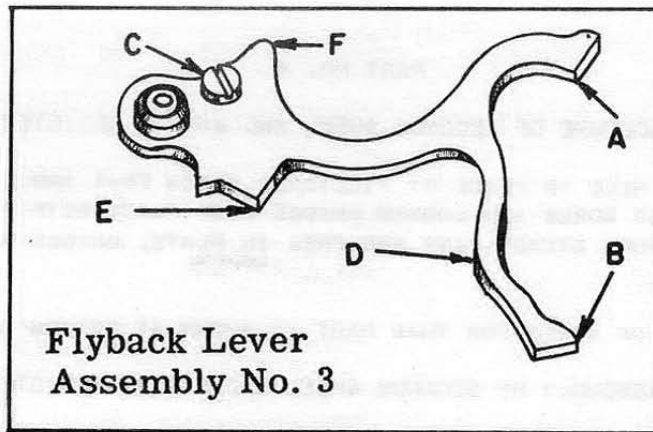

**Flyback Lever
Assembly No. 3**

OILING

These points on flyback lever should be slightly moistened with oil.

1. The stud that flyback lever pivots on.
2. Point D on flyback lever that contacts intermittent lever.
3. Point E on flyback lever that contacts Pin C on brake lever.
4. Point F on flyback lever that contacts Push Piece for setting back to zero.

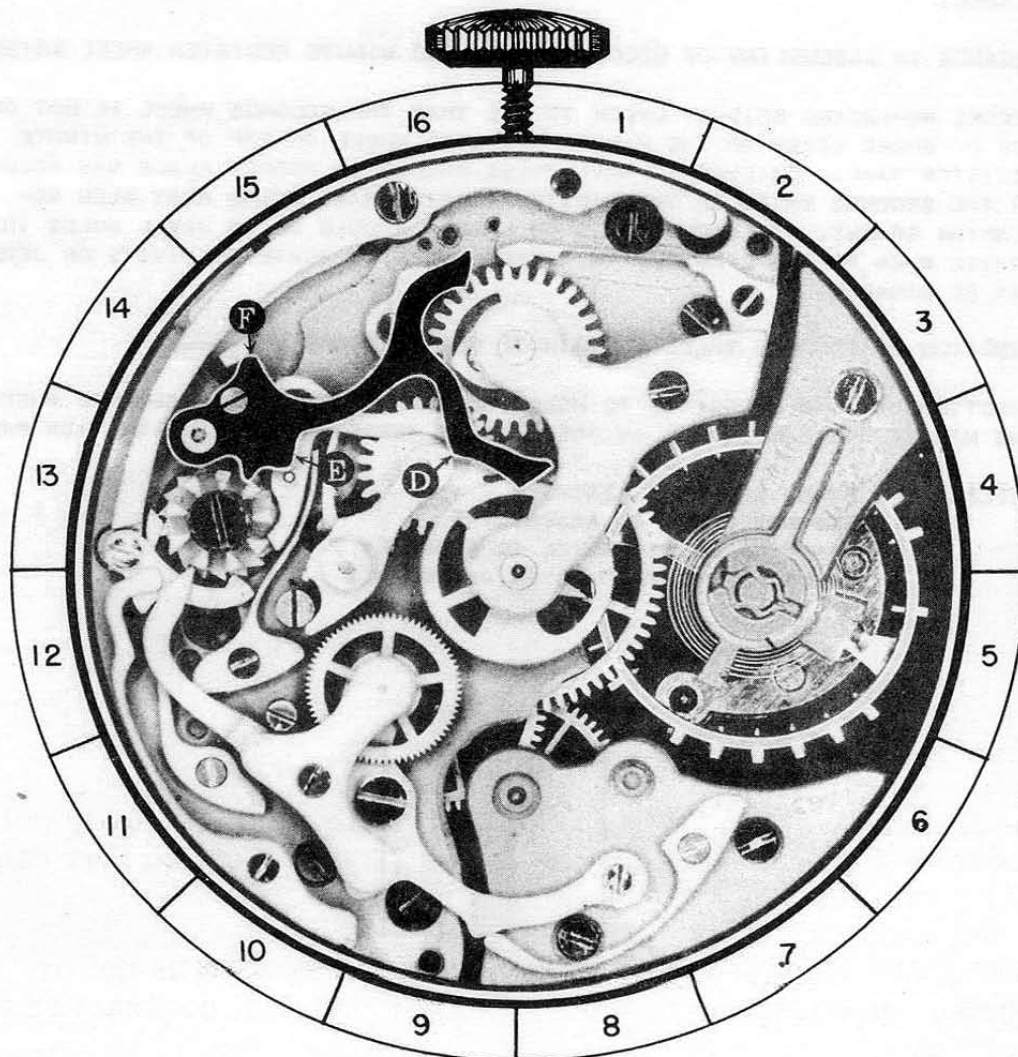

PART NO. 4

A. DISASSEMBLY PROCEDURE OF SECONDS WHEEL AND MINUTE REGISTER WHEEL BRIDGE:

THIS BRIDGE IS HELD IN PLACE BY FILLISTER SCREW FS-1 AND STEADY PINS. REMOVE FILLISTER SCREW AND LOOSEN BRIDGE FROM PLATE WITH A THIN BLADE SCREWDRIVER. WHEN STEADY PINS ARE FREE IN PLATE, BRIDGE MAY BE LIFTED FROM MOVEMENT.

(THE SHAPE OF SCREW FOR THIS PART IS SHOWN AT BOTTOM OF PAGE)

B. HAZARDS IN DISASSEMBLY OF SECONDS WHEEL AND MINUTE REGISTER WHEEL BRIDGE:

WHEN REMOVING BRIDGE FROM PLATE, DO NOT TWIST BRIDGE OR IT MAY DAMAGE PIVOTS ON WHEELS OR CHIP JEWELS IN BRIDGE. THE SCREWDRIVER SHOULD BE CAREFULLY USED IN THIS OPERATION TO PREVENT MARRING OF BRIDGE OR PLATE.

C. ASSEMBLY PROCEDURE OF SECONDS WHEEL AND MINUTE REGISTER WHEEL BRIDGE:

THIS BRIDGE IS PLACED ON PLATE WITH STEADY PINS IN BRIDGE OVER PROPER HOLES IN PLATE. PLACE TOP PIVOTS OF SECONDS WHEEL AND MINUTE REGISTER WHEEL SO THEY WILL ENTER JEWELS IN BRIDGE. BRIDGE MAY NOW BE PRESSED DOWN TO PROPER PLACE WITH BACK OF TWEEZERS AND FILLISTER SCREW FS-1 REPLACED.

D. HAZARDS IN ASSEMBLING OF SECONDS WHEEL AND MINUTE REGISTER WHEEL BRIDGE:

BEFORE REPLACING BRIDGE, CHECK TO SEE THAT THE SECONDS WHEEL IS NOT ON TOP OF BRAKE LEVER OR THE MINUTE REGISTER WHEEL ON TOP OF THE MINUTE REGISTER PAWL. FAILURE TO HAVE THESE WHEELS IN PROPER PLACE MAY RESULT IN THE SECONDS WHEEL OR THE MINUTE REGISTER PAWL BEING BENT WHEN REPLACING BRIDGE. THE TOP PIVOTS ON WHEELS SHOULD BE IN JEWEL HOLES IN BRIDGE WHEN PRESSING BRIDGE TO PROPER PLACE ON PLATE OR PIVOTS OR JEWELS MAY BE DAMAGED.

E. FUNCTION OF SECONDS WHEEL AND MINUTE REGISTER WHEEL BRIDGE:

FUNCTION OF THIS BRIDGE IS TO HOLD THE TOP PIVOTS OF THE SECONDS WHEEL AND MINUTE REGISTER WHEEL IN POSITION SO THESE WHEELS CAN FUNCTION PROPERLY.

REFERENCE: BRAKE LEVER IS ASSEMBLY 9
SECONDS WHEEL IS ASSEMBLY 5
MINUTE REGISTER WHEEL IS ASSEMBLY 7
MINUTE REGISTER PAWL IS ASSEMBLY 8

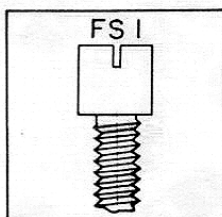

Seconds Wheel Minute Register
Wheel Bridge

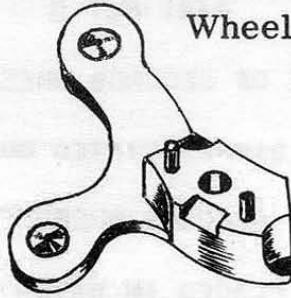

Assembly No. 4

OILING

The pivots in the jewels in the bridge should be oiled as you would properly oil a train pivot in a watch.

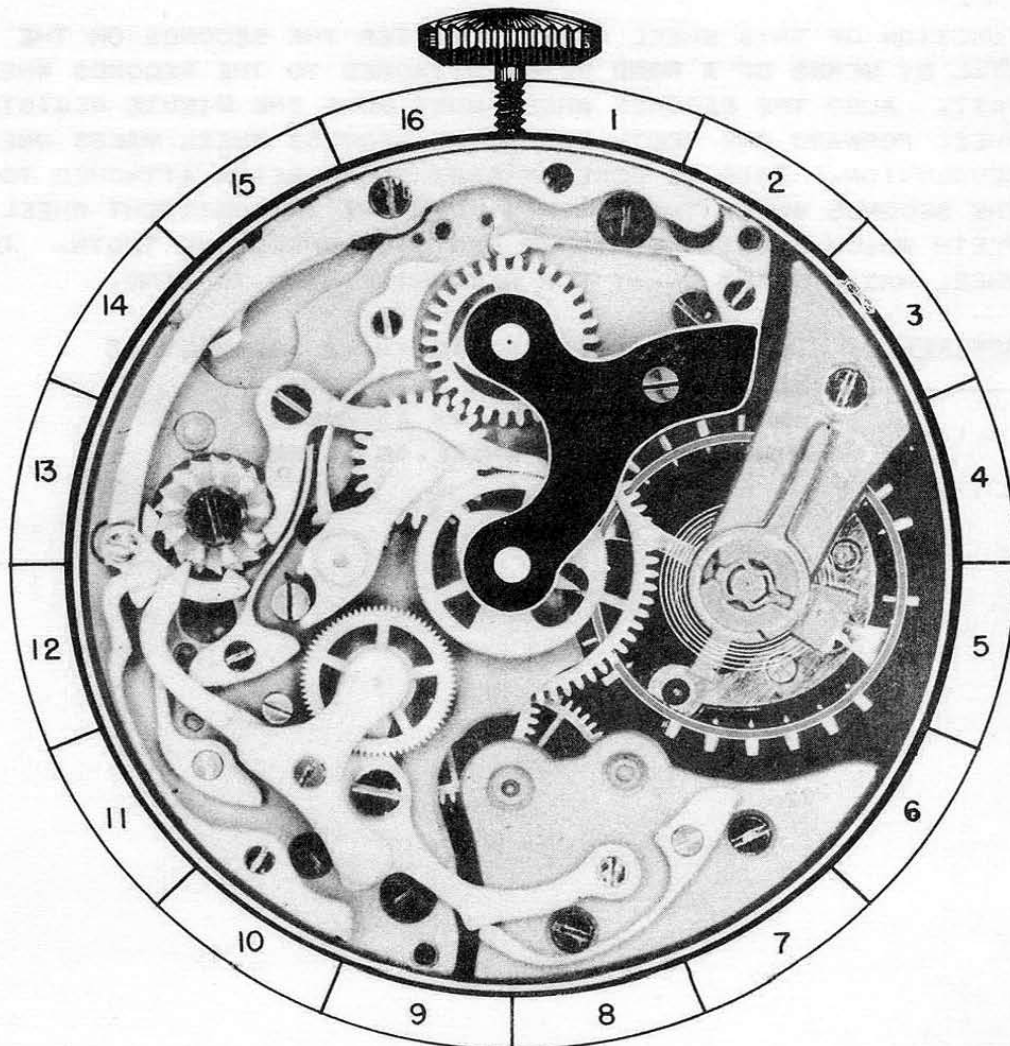

4 - A

PART NO. 5

A. DISASSEMBLY PROCEDURE OF SECONDS WHEEL:

THE SECONDS WHEEL IS SIMPLY LIFTED OUT OF PLACE.

B. ASSEMBLY PROCEDURE OF SECONDS WHEEL:

THE SECONDS WHEEL IS PLACED IN WATCH WITH THE LONG POST "A" DOWN IN HOLLOW CENTER WHEEL PINION. THE SECONDS WHEEL BRAKE SHOULD BE MOVED OUT SLIGHTLY SO THE SECONDS WHEEL DOES NOT SET ON TOP OF THE BRAKE LEVER.

C. HAZARDS IN ASSEMBLING OF SECONDS WHEEL:

FAILURE TO MOVE THE SECONDS WHEEL BRAKE FROM UNDER WHEEL MAY RESULT IN THE WHEEL BEING BENT WHEN BRIDGE IS REPLACED.

D. FUNCTION OF SECONDS WHEEL:

FUNCTION OF THIS WHEEL IS TO REGISTER THE SECONDS ON THE DIAL BY MEANS OF A HAND BEING ATTACHED TO THE SECONDS WHEEL POST. ALSO THE SECONDS WHEEL MUST MOVE THE MINUTE REGISTER WHEEL FORWARD ONE TOOTH EACH TIME SECONDS WHEEL MAKES ONE REVOLUTION. THIS IS DONE BY DART TOOTH BEING ATTACHED TO THE SECONDS WHEEL THAT MESHES INTO THE INTERMITTENT WHEEL TEETH WHICH MOVES THE MINUTE REGISTER WHEEL ONE TOOTH. THIS WHEEL HAS A HEART ON IT FOR RETURNING HAND TO ZERO.

REFERENCE: SECONDS WHEEL DART TOOTH IS ASSEMBLY 5C
SECONDS WHEEL HEART IS ASSEMBLY 5B
INTERMITTENT WHEEL IS ASSEMBLY 11A
MINUTE REGISTER WHEEL IS ASSEMBLY 7

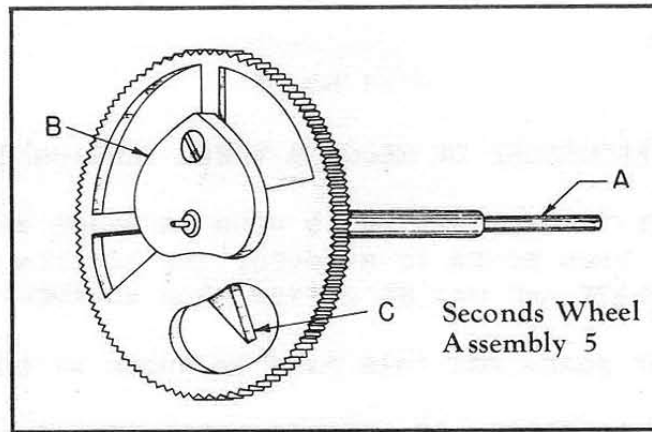

OILING

The top pivot of the seconds wheel should be oiled after bridge for this wheel is placed in watch.

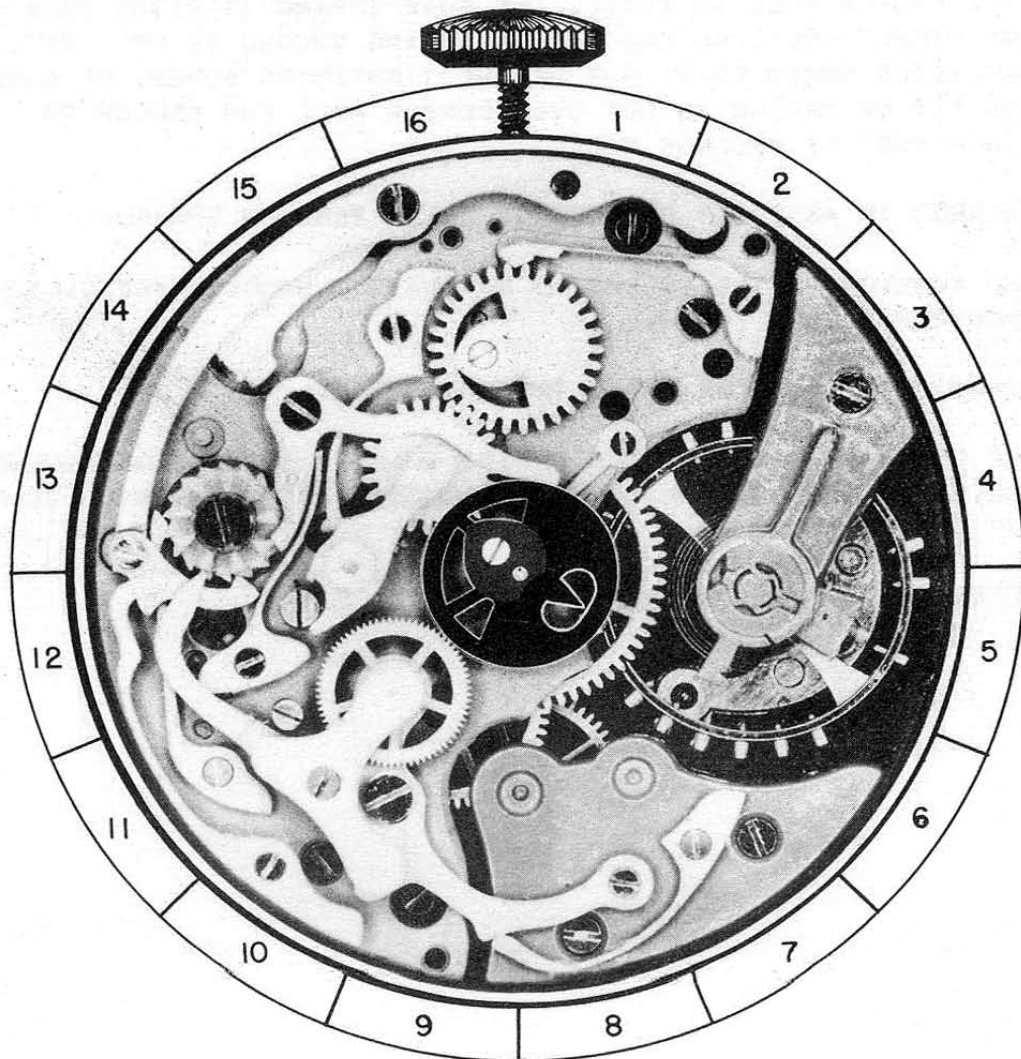

5 - A

PART NO. 6

A. DISASSEMBLY PROCEDURE OF SECONDS WHEEL TENSION SPRING:

SECONDS WHEEL TENSION SPRING IS HELD IN PLACE WITH FILLISTER SCREW FS-2. WHEN SCREW IS REMOVED, THE TENSION SPRING WILL BE FREE OF PLATE AND MAY BE LIFTED FROM MOVEMENT.

(THE SHAPE OF SCREW FOR THIS PART IS SHOWN AT BOTTOM OF PAGE)

B. HAZARDS IN DISASSEMBLY OF SECONDS WHEEL TENSION SPRING:

THE TENSION SPRING SHOULD BE HANDLED CAREFULLY WHEN REMOVING IT FROM WATCH. IT IS A VERY THIN SPRING AND CAN EASILY BE MUTILATED.

C. ASSEMBLY PROCEDURE OF SECONDS WHEEL TENSION SPRING:

THE TENSION SPRING IS PLACED ON PLATE WITH HOLE IN SPRING OVER PROPER HOLE IN PLATE. BE SURE SPRING IS RIGHT SIDE UP. THE HIGHLY POLISHED END "A" OF SPRING SHOULD BE UP. REPLACE FILLISTER SCREW FS-2, BUT BEFORE TIGHTENING SCREW, BE SURE END "A" OF SPRING IS NOT OVER CENTER HOLE FAR ENOUGH TO TOUCH POST OF SECONDS WHEEL.

D. HAZARDS IN ASSEMBLY OF SECONDS WHEEL TENSION SPRING:

THE TENSION SPRING IS EASILY MUTILATED, HANDLE CAREFULLY WHEN REPLACING.

E. FUNCTION OF SECONDS WHEEL TENSION SPRING:

THE SECONDS WHEEL TENSION SPRING HOLDS A TENSION ON SECONDS WHEEL TO KEEP IT TURNING WITH A SMOOTH ACTION WITH NO JUMPING OR JERKING.

REFERENCE: SECONDS WHEEL IS ASSEMBLY 5

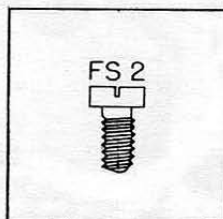



Seconds Wheel Tension Spring
Assembly No. 6

OILING

Seconds wheel tension spring should not be oiled.

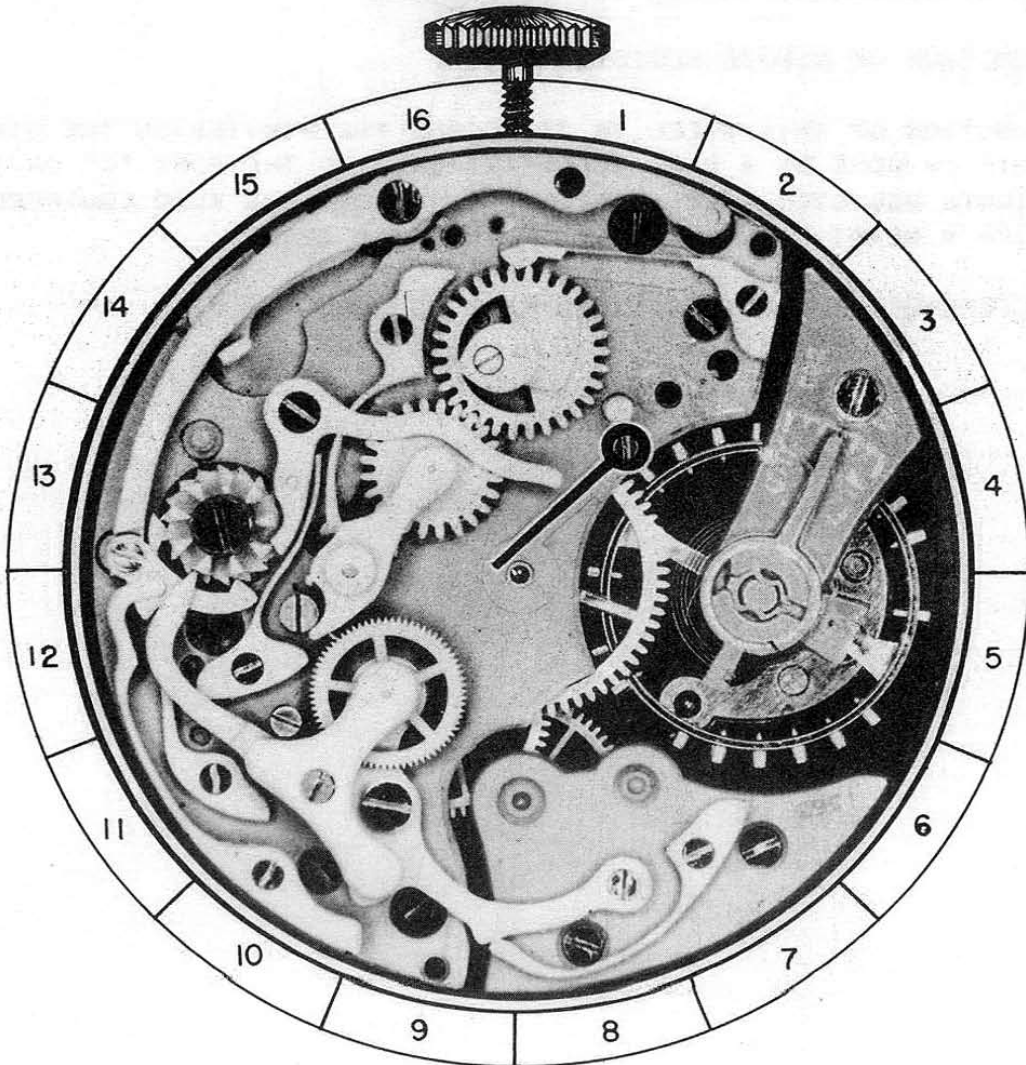

6 - A

PART NO. 7

A. DISASSEMBLY PROCEDURE OF MINUTE REGISTER WHEEL:

THIS WHEEL IS EASILY REMOVED. IT IS SIMPLY LIFTED OUT OF PLACE.

B. ASSEMBLY PROCEDURE OF MINUTE REGISTER WHEEL:

THE LONG POST "B" OF MINUTE REGISTER WHEEL SHOULD BE PLACED DOWN IN HOLE IN BUSHING. THE MINUTE REGISTER PAWL SHOULD BE MOVED SO THE MINUTE REGISTER WHEEL DOES NOT SET ON TOP OF MINUTE REGISTER PAWL. THE END "A" OF PAWL SHOULD BE BETWEEN TWO TEETH ON MINUTE REGISTER WHEEL.

C. HAZARDS IN ASSEMBLING OF MINUTE REGISTER WHEEL:

FAILURE TO MOVE END "A" OF MINUTE REGISTER PAWL FROM UNDER MINUTE REGISTER WHEEL MAY RESULT IN THE MINUTE REGISTER PAWL BEING BENT WHEN BRIDGE IS REPLACED.

D. FUNCTION OF MINUTE REGISTER WHEEL:

FUNCTION OF THIS WHEEL IS TO RECORD THE MINUTES ON THE DIAL. THIS IS DONE BY A HAND BEING ATTACHED TO THE POST "B" ON THE MINUTE REGISTER WHEEL PINION. THIS WHEEL IS ALSO EQUIPPED WITH A HEART FOR RETURNING THE HAND TO ZERO.

REFERENCE: MINUTE REGISTER PAWL IS ASSEMBLY 8

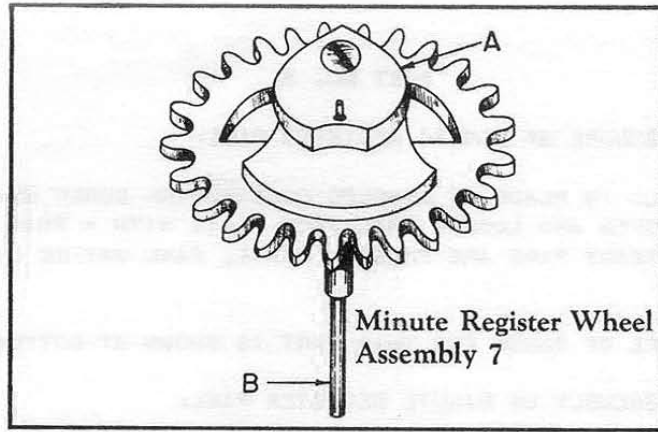

OILING

The top and bottom pivot of minute register wheel should be oiled as you would normally oil train pivots in a watch. These pivots of course should not be oiled until bridge is replaced.

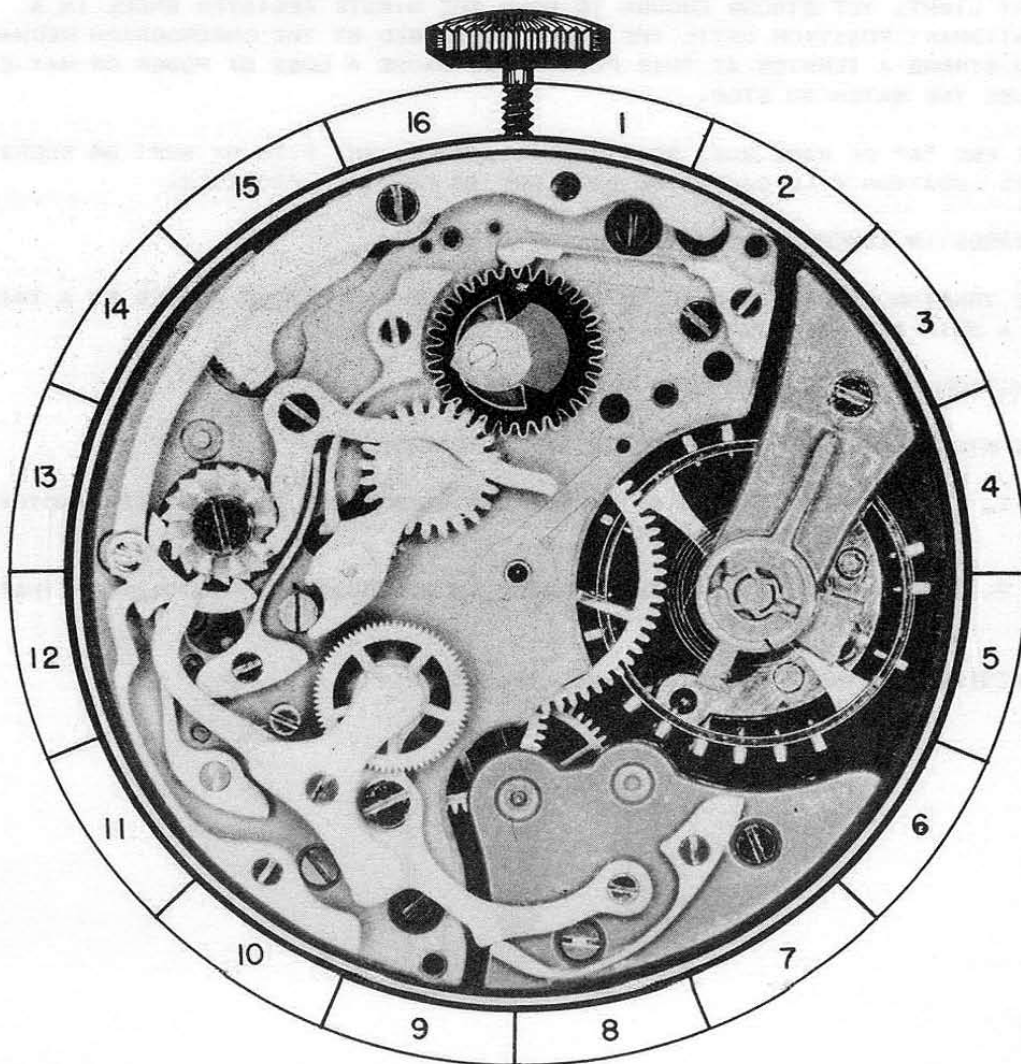

7 - A

PART NO. 8

A. DISASSEMBLY PROCEDURE OF MINUTE REGISTER PAWL:

THIS PAWL IS HELD IN PLACE BY BEVELED COUNTERSINK SCREW BS-2 AND STEADY PINS. REMOVE SCREW AND LOOSEN PAWL FROM PLATE WITH A THIN BLADE SCREW-DRIVER. WHEN STEADY PINS ARE FREE IN PLATE, PAWL MAY BE LIFTED FROM MOVEMENT.

(THE SHAPE OF SCREW FOR THIS PART IS SHOWN AT BOTTOM OF PAGE)

B. HAZARDS IN DISASSEMBLY OF MINUTE REGISTER PAWL:

THIS TENSION SPRING ON PAWL IS VERY DELICATE AND CAN BE EASILY RUINED BY A SLIGHT SLIP OF THE TOOL.

C. ASSEMBLY PROCEDURE OF MINUTE REGISTER PAWL:

PLACE PAWL ON PLATE WITH STEADY PINS OVER PROPER HOLES IN PLATE, THEN PRESS PAWL DOWN TO CORRECT POSITION AND REPLACE BEVELED COUNTERSINK SCREW BS-2.

CAUTION: THE TENSION OF END "A" OF PAWL ON MINUTE REGISTER WHEEL MUST BE VERY LIGHT, YET STRONG ENOUGH TO HOLD THE MINUTE REGISTER WHEEL IN A STATIONARY POSITION UNTIL THE WHEEL IS TURNED BY THE CHRONOGRAPH MECHANISM. TOO STRONG A TENSION AT THIS POINT WILL CAUSE A LOSS OF POWER OR MAY EVEN CAUSE THE WATCH TO STOP.

THE END "A" OF PAWL MUST BE HIGHLY POLISHED, ANY PITS OF RUST OR BURRS AT THIS LOCATION WILL CAUSE THE PAWL NOT TO FUNCTION PROPERLY.

D. HAZARDS IN ASSEMBLY OF MINUTE REGISTER PAWL:

THE TENSION SPRING ON PAWL IS VERY DELICATE AND CAN BE RUINED BY A TWIST OR A SLIP OF THE TOOL.

E. FUNCTION OF MINUTE REGISTER PAWL:

THE MINUTE REGISTER PAWL SERVES TWO PURPOSES:

1. IT HOLDS A TENSION ON MINUTE REGISTER WHEEL SO IT MOVES EXACTLY ONE TOOTH EACH MINUTE.
2. IT HOLDS MINUTE REGISTER WHEEL IN A STATIONARY POSITION SO THAT A BUMP CANNOT ALTER IT.

REFERENCE: MINUTE REGISTER WHEEL IS ASSEMBLY 7

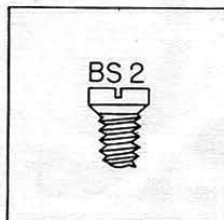

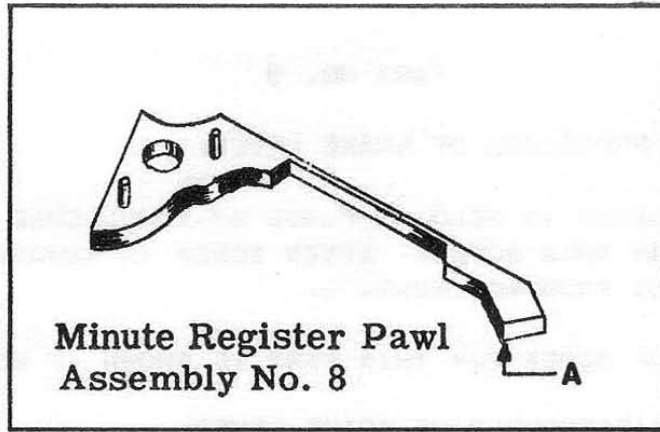

OILING

The minute register pawl should not be oiled.

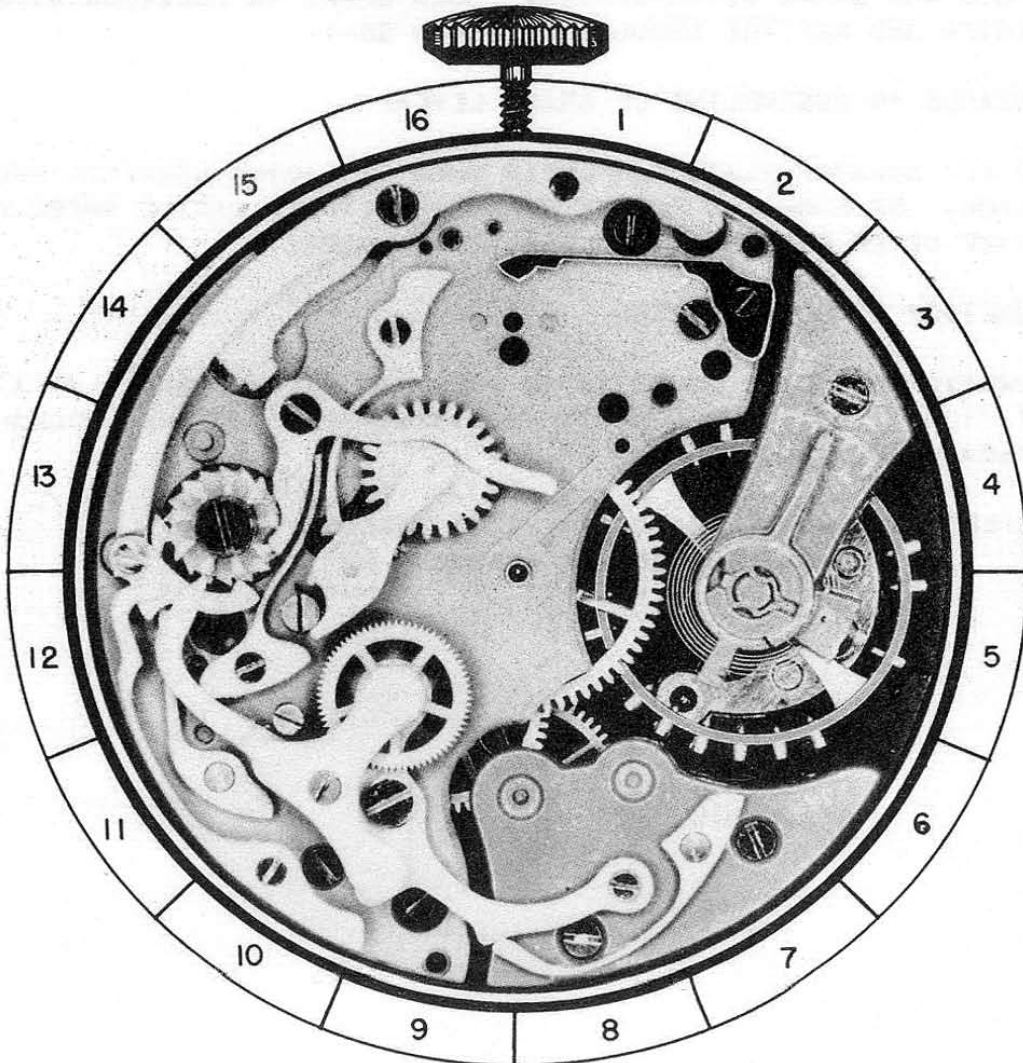

8 - A

PART NO. 9

A. DISASSEMBLY PROCEDURE OF BRAKE LEVER:

THIS BRAKE LEVER IS HELD IN PLACE BY SHOULDERED SCREW SS-1 AND PIVOTS ON THIS SCREW. AFTER SCREW IS REMOVED, BRAKE LEVER MAY BE LIFTED FROM MOVEMENT.

(THE SHAPE OF SCREW FOR THIS PART IS SHOWN AT BOTTOM OF PAGE)

B. HAZARDS IN DISASSEMBLY OF BRAKE LEVER:

HOLD FINGER ON BRAKE LEVER WHEN REMOVING SCREW SO SCREW DOES NOT SHOOT AWAY AND BE LOST.

C. ASSEMBLY PROCEDURE OF BRAKE LEVER:

PLACE BRAKE ON PLATE WITH PIN "C" UP. SLIDE BRAKE ON PLATE TO ITS PROPER POSITION WITH END "A" OF BRAKE BETWEEN CASTLE WHEEL AND BRAKE LEVER SPRING. HOLD BRAKE IN POSITION WITH FINGER AND REPLACE SHOULDERED SCREW SS-1.

D. HAZARDS IN ASSEMBLING OF BRAKE LEVER:

DO NOT SCRATCH PLATES OR LEVER WHEN REPLACING BRAKE TO PROPER PLACE. BE SURE END "A" OF BRAKE IS BETWEEN CASTLE WHEEL AND BRAKE LEVER SPRING BEFORE REPLACING SCREW.

E. FUNCTION OF BRAKE LEVER:

FUNCTION OF BRAKE LEVER IS TO HOLD THE SECONDS WHEEL IN A STATIONARY POSITION WHEN IT IS DISENGAGED FROM THE CHRONOGRAPH MECHANISM.

REFERENCE: BRAKE LEVER SPRING IS ASSEMBLY 16
CASTLE WHEEL IS ASSEMBLY 22

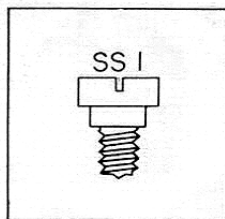

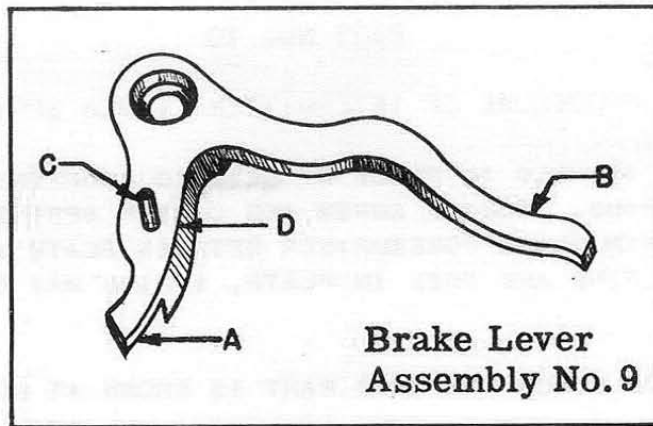

Brake Lever
Assembly No. 9

OILING

The shouldered screw the brake lever pivots on should be slightly moistened with oil. The point 'D' on brake lever should be slightly moistened with oil at point of contact with brake lever spring.

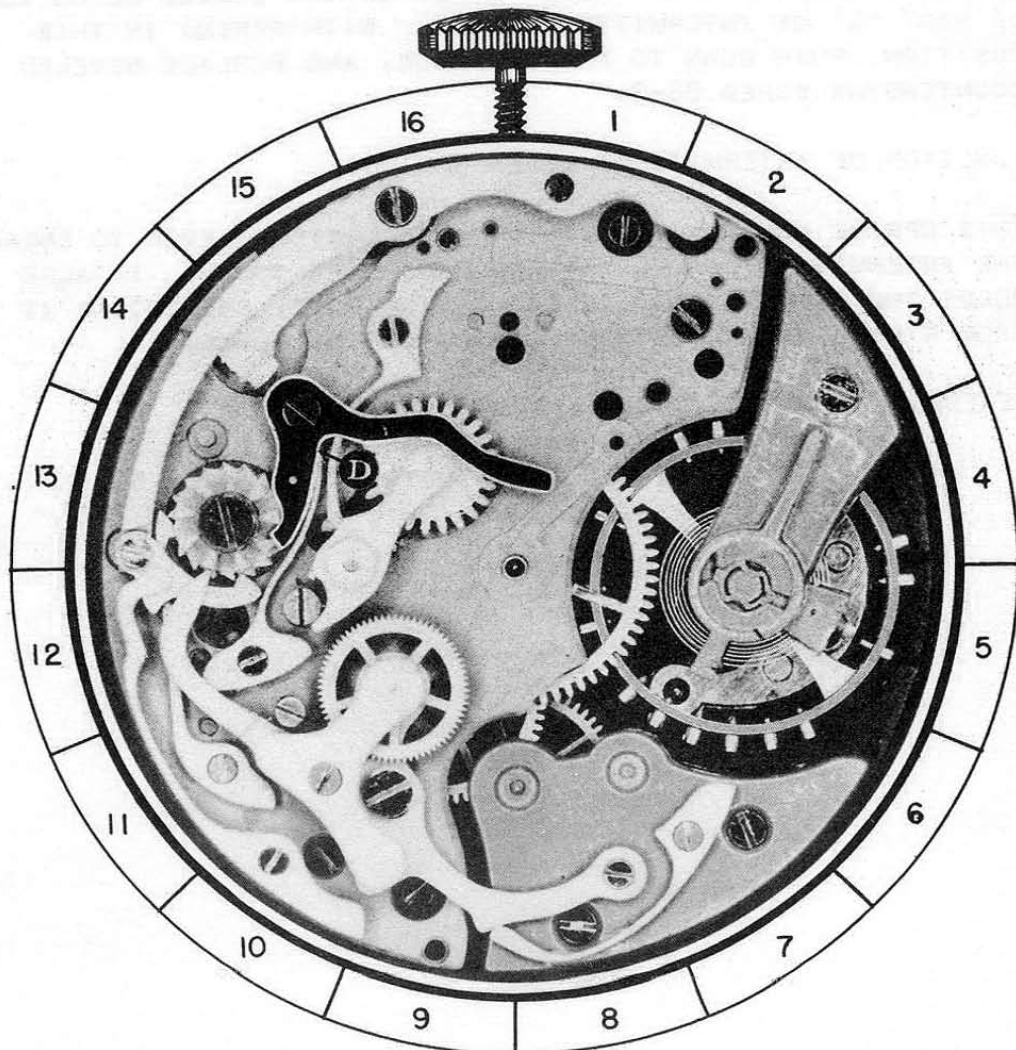

9 - A

PART NO. 10

A. DISASSEMBLY PROCEDURE OF INTERMITTENT LEVER SPRING:

THIS SPRING IS HELD IN PLACE BY BEVELED COUNTERSINK SCREW BS-3 AND STEADY PINS. REMOVE SCREW AND LOOSEN SPRING FROM PLATE BY SLIDING A THIN BLADE SCREWDRIVER BETWEEN PLATE AND SPRING. WHEN STEADY PINS ARE FREE IN PLATE, SPRING MAY BE LIFTED FROM MOVEMENT.

(THE SHAPE OF SCREW FOR THIS PART IS SHOWN AT BOTTOM OF PAGE)

B. HAZARDS IN DISASSEMBLY OF INTERMITTENT LEVER SPRING:

SCREWDRIVER SHOULD BE CAREFULLY USED WHEN LOOSENING SPRING FROM PLATE TO PREVENT MARRING OF PLATE OR SPRING.

C. ASSEMBLY PROCEDURE OF INTERMITTENT LEVER SPRING:

PLACE SPRING IN ITS PROPER POSITION WITH STEADY PINS OVER PROPER HOLES IN PLATE. END "A" OF SPRING SHOULD BE ON TOP OF PART "B" OF INTERMITTENT LEVER. WITH SPRING IN THIS POSITION, PUSH DOWN TO PROPER PLACE, AND REPLACE BEVELED COUNTERSINK SCREW BS-3.

D. FUNCTION OF INTERMITTENT LEVER SPRING:

THIS SPRING HOLDS A TENSION ON INTERMITTENT LEVER TO ENGAGE THE INTERMITTENT WHEEL WITH SECONDS DART TOOTH. IT ALSO HOLDS THE INTERMITTENT LEVER DOWN ON POST, PREVENTING IT FROM RIDING UP ON POST AND COMING OUT OF PLACE.

REFERENCE: INTERMITTENT LEVER IS ASSEMBLY 11
INTERMITTENT WHEEL IS ASSEMBLY 11A
SECONDS WHEEL DART TOOTH IS ASSEMBLY 5C

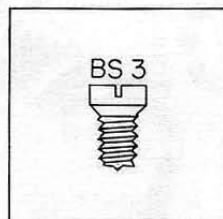

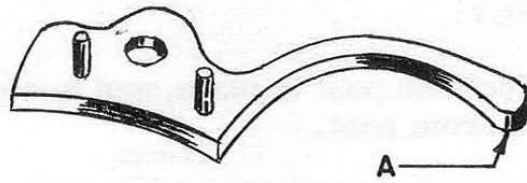

Intermittent Lever Spring
Assembly No. 10

OILING

End A of spring should be slightly moistened with oil at the point it contacts intermittent lever and wheel assembly.

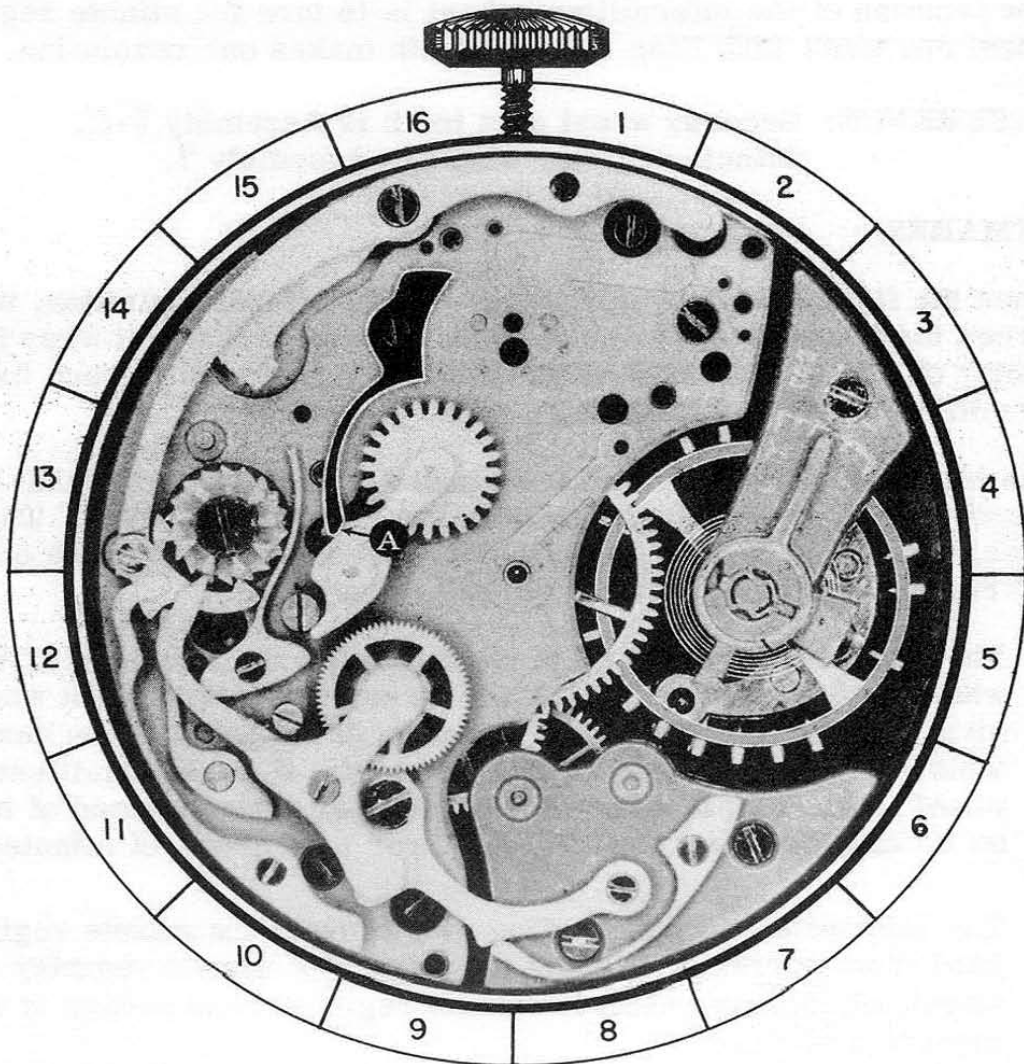

10 - A

PART NO. 11

A. DISASSEMBLY PROCEDURE OF INTERMITTENT LEVER AND WHEEL ASSEMBLY:

This assembly pivots on post in plate, and to remove it, simply lift intermittent lever from post.

B. ASSEMBLY PROCEDURE OF INTERMITTENT LEVER AND WHEEL ASSEMBLY:

Place hole in bushing in intermittent lever over proper post in plate as shown in picture. Now push assembly down to proper place. Assembly should pivot freely on post.

C. FUNCTION OF INTERMITTENT LEVER AND WHEEL ASSEMBLY:

The function of the intermittent lever is to engage and disengage the intermittent wheel with the seconds wheel dart tooth.

The function of the intermittent wheel is to turn the minute register wheel one tooth each time the dart tooth makes one revolution.

REFERENCE: Seconds wheel dart tooth is Assembly 5-C.
Minute register wheel is Assembly 7.

REMARKS:

When the flyback lever returns the wheels to a zero position, it forces the intermittent lever to move intermittent wheel away from center of watch, making it impossible for dart tooth to touch the intermittent wheel at this time.

The intermittent wheel should be carefully checked to see that it has proper endshake and spins freely in the intermittent lever. This wheel must, of necessity, spin freely, as any excess friction on the intermittent wheel may cause the following errors:

1. The intermittent wheel teeth meshing with the minute register wheel teeth which are stationary causes the intermittent wheel to pivot and turn on its axis as it moves to engage with the dart tooth. When engaging with the dart tooth, if the intermittent wheel is binding, it turns minute register wheel instead of turning on its axis and may result in an error in register of minutes.
2. The intermittent wheel binding may prevent the minute register pawl from correctly spacing the turning of minute register wheel, which may result in minute register hand setting at an incorrect position.

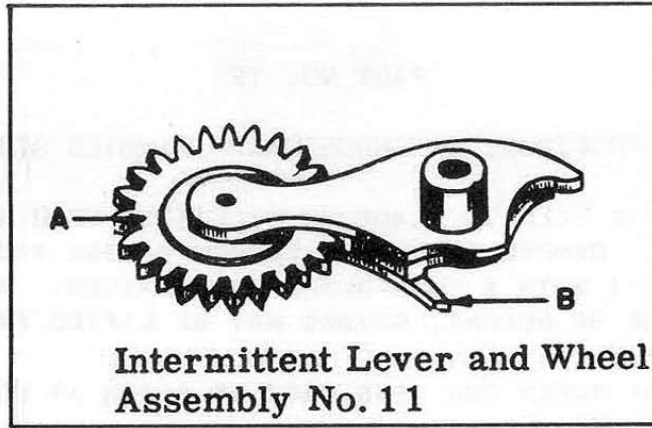

OILING

The post that intermittent lever and wheel assembly pivots on should be slightly moistened with oil.

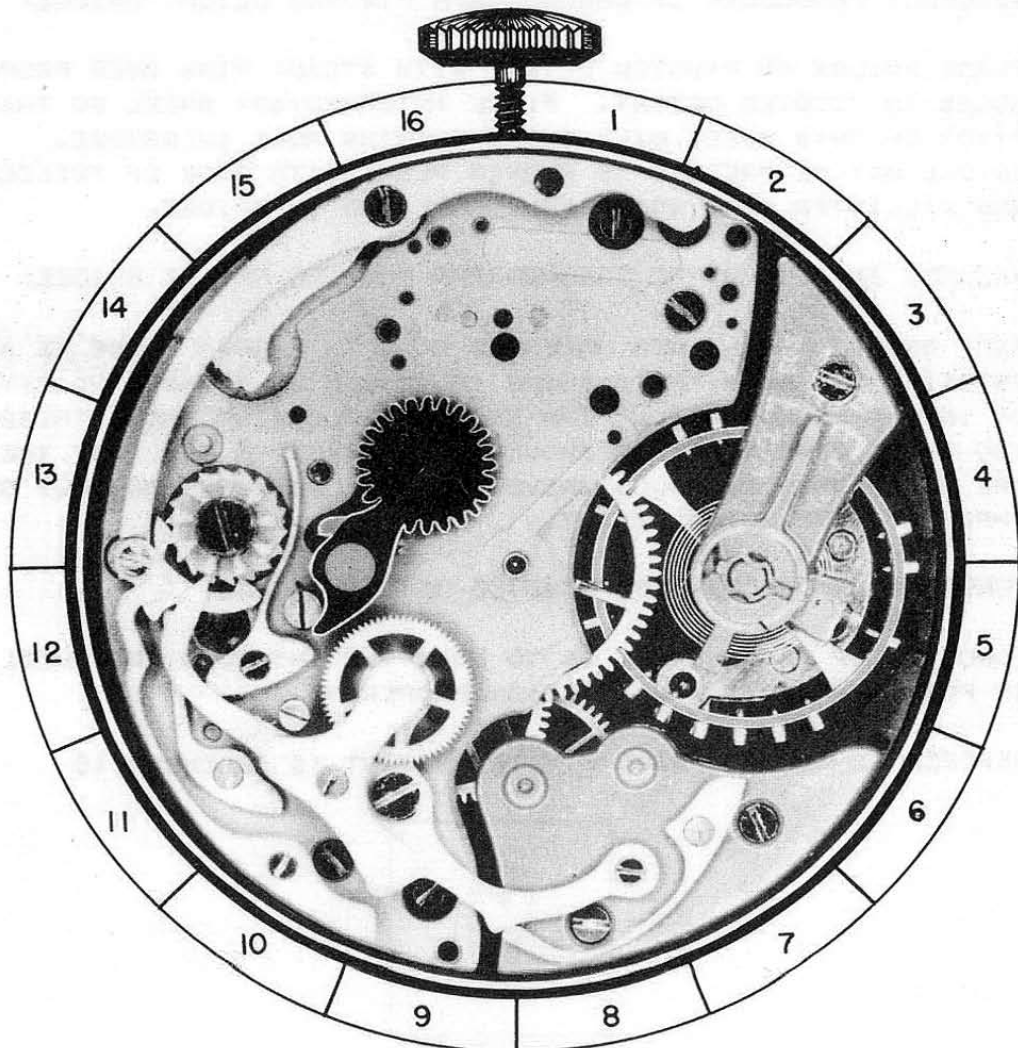

11 - A

PART NO. 12

A. DISASSEMBLY PROCEDURE OF CHRONOGRAPH PIVOTED DETENT BRIDGE:

THIS BRIDGE IS HELD IN PLACE BY FILLISTER HEAD SCREW FS-3 AND STEADY PINS. REMOVE SCREW AND LOOSEN BRIDGE FROM CHRONOGRAPH PIVOTED DETENT WITH A THIN BLADE SCREWDRIVER. WHEN STEADY PINS ARE FREE OF DETENT, BRIDGE MAY BE LIFTED FROM MOVEMENT.

(THE SHAPE OF SCREW FOR THIS PART IS SHOWN AT BOTTOM OF PAGE)

B. HAZARDS IN DISASSEMBLY OF CHRONOGRAPH PIVOTED DETENT BRIDGE:

WHEN USING A SCREWDRIVER TO LOOSEN THE BRIDGE FROM DETENT, CARE SHOULD BE TAKEN TO KEEP BRIDGE LEVEL, AS ANY TWISTING MAY DAMAGE PIVOT ON INTERMEDIARY WHEEL OR BURR THE BUSHINGS IN BRIDGE OR PIVOTED DETENT. THE SCREWDRIVER SHOULD BE CAREFULLY USED TO PREVENT MARRING OF BRIDGE OR DETENT.

C. ASSEMBLY PROCEDURE OF CHRONOGRAPH PIVOTED DETENT BRIDGE:

PLACE BRIDGE ON PIVOTED DETENT WITH STEADY PINS OVER PROPER HOLES IN PIVOTED DETENT. PLACE INTERMEDIARY WHEEL SO THAT PIVOT ON THIS WHEEL WILL ENTER BUSHING HOLE IN BRIDGE. BRIDGE MAY BE PRESSED TO PROPER PLACE WITH BACK OF TWEEZERS AND FILLISTER HEAD SCREW FS-3 REPLACED IN BRIDGE.

D. HAZARDS IN ASSEMBLING CHRONOGRAPH PIVOTED DETENT BRIDGE:

KEEP BRIDGE LEVEL WHEN PRESSING DOWN TO PROPER PLACE AS ANY TWISTING MAY BURR THE BUSHING IN BRIDGE OR DAMAGE THE PIVOT ON INTERMEDIARY WHEEL. THE BRIDGE AND DETENT WHERE THESE TWO PARTS COME TOGETHER SHOULD BE CHECKED TO SEE THAT THERE ARE NO BURRS THAT WOULD PREVENT BRIDGE SETTING PROPERLY ON CHRONOGRAPH PIVOTED DETENT.

E. FUNCTION OF CHRONOGRAPH PIVOTED DETENT BRIDGE:

FUNCTION OF THIS BRIDGE IS TO HOLD THE INTERMEDIARY WHEEL IN POSITION SO IT CAN FUNCTION PROPERLY.

REFERENCE: CHRONOGRAPH PIVOTED DETENT IS ASSEMBLY 15

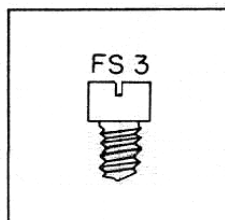

**Chronograph
Pivoted
Detent Bridge**

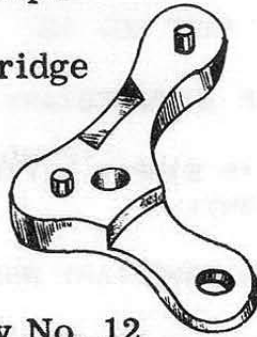

Assembly No. 12

OILING

The pivot in bushing in chronograph pivoted detent bridge should be oiled as you would properly oil a train pivot in a watch.

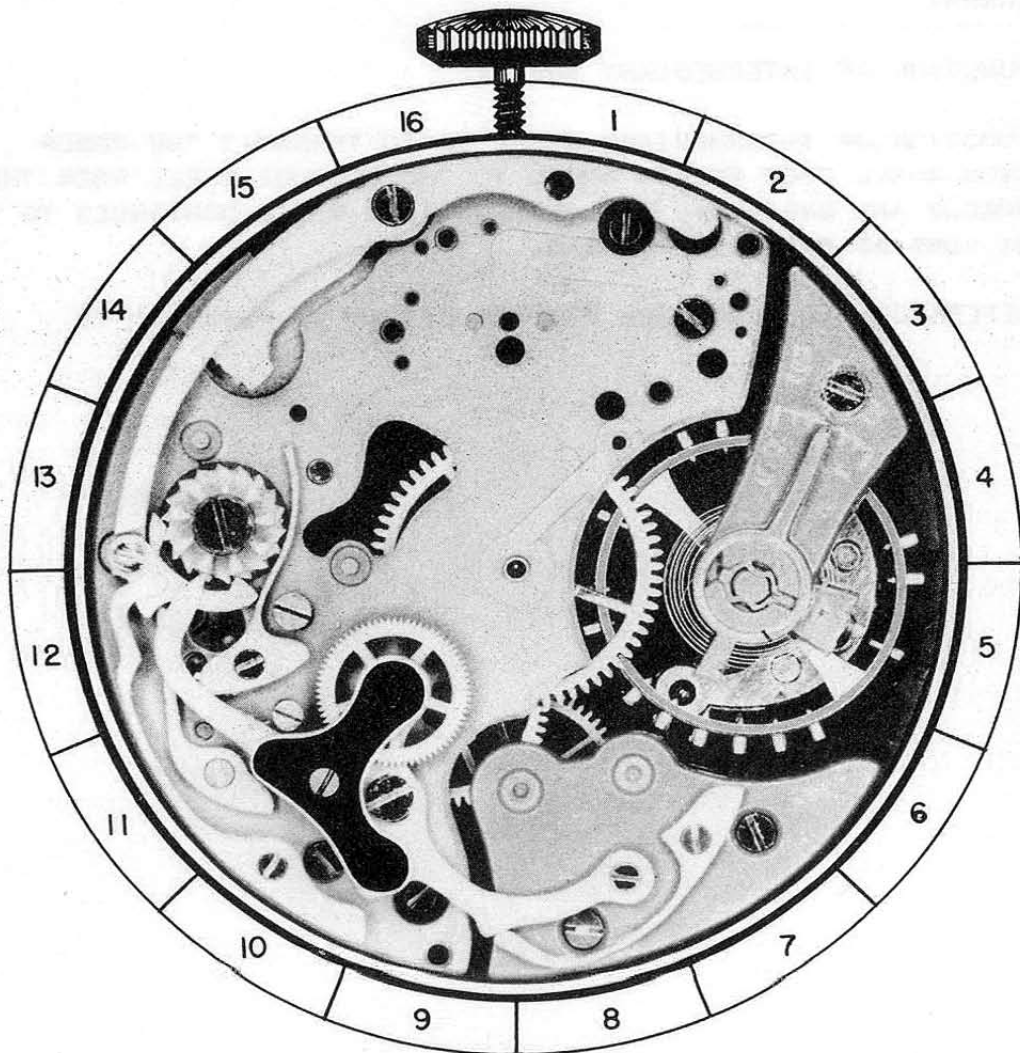

12 - A

PART NO. 13

A. DISASSEMBLY PROCEDURE OF INTERMEDIARY WHEEL:

THE INTERMEDIARY WHEEL IS SIMPLY LIFTED OUT OF BUSHING IN CHRONOGRAPH PIVOTED DETENT.

B. ASSEMBLY PROCEDURE OF INTERMEDIARY WHEEL:

WHEN REPLACING THE INTERMEDIARY WHEEL, THE LONG END OF STAFF "A" SHOULD BE UP. PLACE THE BOTTOM PIVOT OF STAFF IN HOLE IN BUSHING OF CHRONOGRAPH PIVOTED DETENT.

C. HAZARDS IN ASSEMBLING OF INTERMEDIARY WHEEL:

PIVOT HOLE IN BUSHING OF CHRONOGRAPH PIVOTED DETENT SHOULD BE CAREFULLY EXAMINED FOR BURRS BEFORE REPLACING INTERMEDIARY WHEEL. ANY IMPERFECTION HERE WILL AFFECT THE TIME-KEEPING OF THE WATCH AND HINDER PROPER OPERATION OF CHRONOGRAPH.

D. FUNCTION OF INTERMEDIARY WHEEL:

FUNCTION OF INTERMEDIARY WHEEL IS TO TRANSMIT THE POWER FROM WHEEL OVER FOURTH WHEEL TO THE SECONDS WHEEL WHEN THESE WHEELS ARE ENGAGED. THE INTERMEDIARY WHEEL CONTINUES TO TURN AS LONG AS WATCH IS RUNNING.

REFERENCE: CHRONOGRAPH PIVOTED DETENT IS ASSEMBLY 15

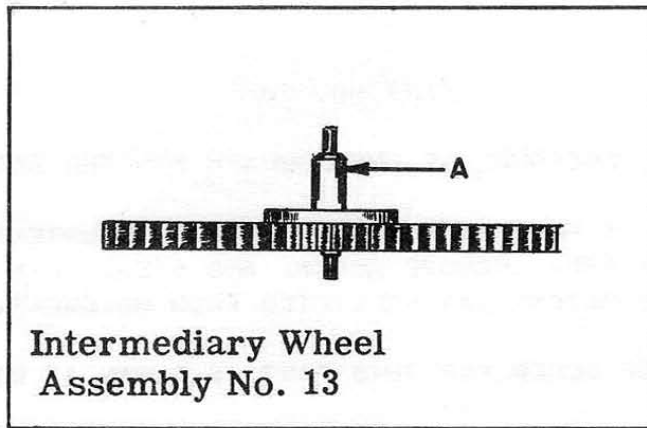

OILING
The bottom pivot of intermediary wheel should be oiled before replacing pivot in place in chronograph pivoted detent. The top pivot should be oiled after bridge for this wheel is placed in watch.

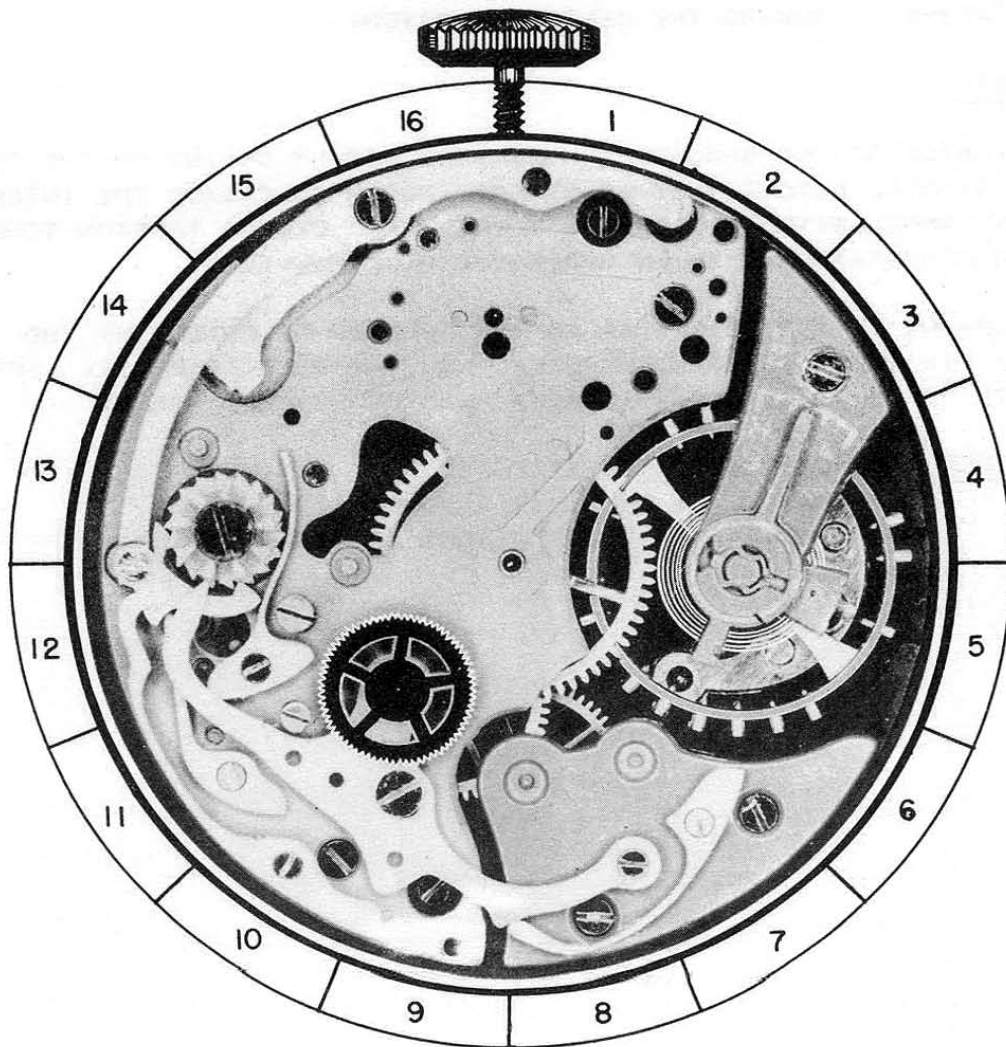

13 - A

PART NO. 14

A. DISASSEMBLY PROCEDURE OF CHRONOGRAPH PIVOTED DETENT SPRING:

THIS SPRING IS HELD IN PLACE BY BEVELED COUNTERSINK SCREW BS-4 AND A STEADY PIN. REMOVE SCREW, AND STEADY PIN WILL BE FREE IN PLATE AND DETENT MAY BE LIFTED FROM MOVEMENT.

(THE SHAPE OF SCREW FOR THIS PART IS SHOWN AT BOTTOM OF PAGE)

B. ASSEMBLY PROCEDURE OF CHRONOGRAPH PIVOTED DETENT SPRING:

PLACE SPRING ON PLATE WITH STEADY PIN OVER PROPER HOLE IN PLATE. PUSH SPRING DOWN TO PROPER PLACE AND REPLACE BEVELED COUNTERSINK SCREW BS-4.

C. FUNCTION OF CHRONOGRAPH PIVOTED DETENT SPRING:

THIS SPRING HOLDS A TENSION ON CHRONOGRAPH PIVOTED DETENT FORCING IT TOWARD THE CENTER OF WATCH.

REMARKS:

THE TENSION OF THE CHRONOGRAPH PIVOTED DETENT SPRING ON THE CHRONOGRAPH PIVOTED DETENT MUST BE STRONG ENOUGH TO ENGAGE THE INTERMEDIARY WHEEL WITH THE SECONDS WHEEL. ANY EXCESS TENSION TENDS TO MAKE CHRONOGRAPH MECHANISM HARDER TO WORK MANUALLY.

THIS SPRING IS ADJUSTABLE AS TO THE TENSION ON DETENT BY THE STEADY PIN BEING SOMEWHAT SMALLER THAN THE HOLE IN PLATE. THIS PERMITS THE SPRING TO PIVOT UNDER HEAD OF BEVELED SCREW.

REFERENCE: SECONDS WHEEL IS ASSEMBLY 5
INTERMEDIARY WHEEL IS ASSEMBLY 13
CHRONOGRAPH PIVOTED DETENT IS ASSEMBLY 15

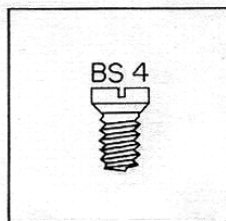

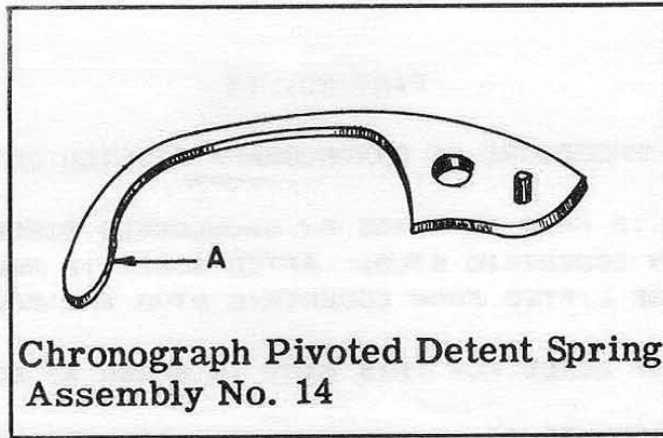

OILING

End "A" of chronograph pivoted detent spring should be slightly moistened with oil.

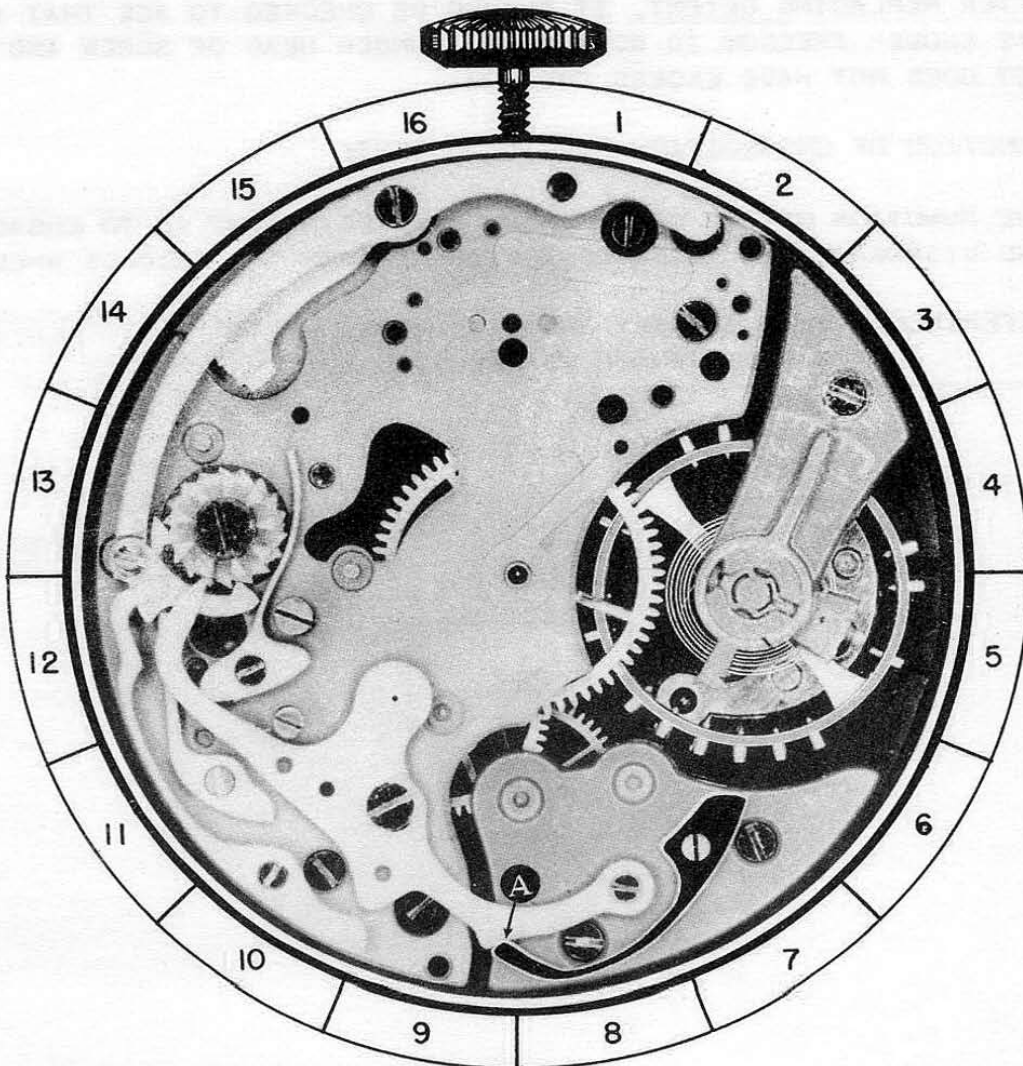

14 - A

PART NO. 15

A. DISASSEMBLY PROCEDURE OF CHRONOGRAPH PIVOTED DETENT:

THIS DETENT IS HELD IN PLACE BY SHOULDERED SCREW SS-2 AND PIVOTS ON AN ECCENTRIC STUD. AFTER SCREW IS REMOVED, THE DETENT MAY BE LIFTED FROM ECCENTRIC STUD AND FREE OF PLATE.

(THE SHAPE OF SCREW FOR THIS PART IS SHOWN AT BOTTOM OF PAGE)

B. ASSEMBLY PROCEDURE OF CHRONOGRAPH PIVOTED DETENT:

PLACE DETENT IN PROPER PLACE ON PLATE WITH HOLE IN END OF DETENT OVER ECCENTRIC STUD, AS DETENT PIVOTS ON THIS STUD. WHEN DETENT IS IN PROPER PLACE, SHOULDERED SCREW SS-2 MAY BE REPLACED. THE DETENT SHOULD WORK FREELY UNDER HEAD OF SCREW.

C. HAZARDS IN ASSEMBLING CHRONOGRAPH PIVOTED DETENT:

AFTER REPLACING DETENT, IT SHOULD BE CHECKED TO SEE THAT IT HAS ENOUGH FREEDOM TO WORK FREELY UNDER HEAD OF SCREW AND YET DOES NOT HAVE EXCESS FREEDOM.

D. FUNCTION OF CHRONOGRAPH PIVOTED DETENT:

THE FUNCTION OF THE CHRONOGRAPH PIVOTED DETENT IS TO ENGAGE AND DISENGAGE THE INTERMEDIARY WHEEL WITH THE SECONDS WHEEL.

REFERENCE: INTERMEDIARY WHEEL IS ASSEMBLY 13
SECONDS WHEEL IS ASSEMBLY 5

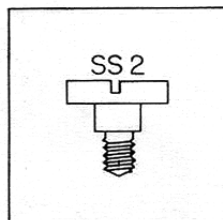

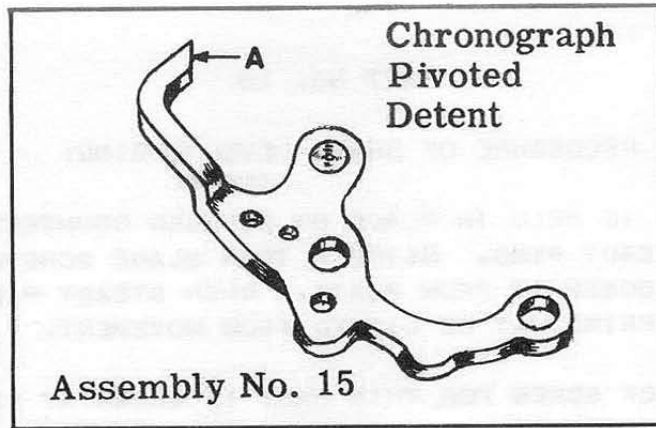

OILING

The Eccentric Stud that chronograph pivoted detent pivots on, should be slightly moistened with oil.

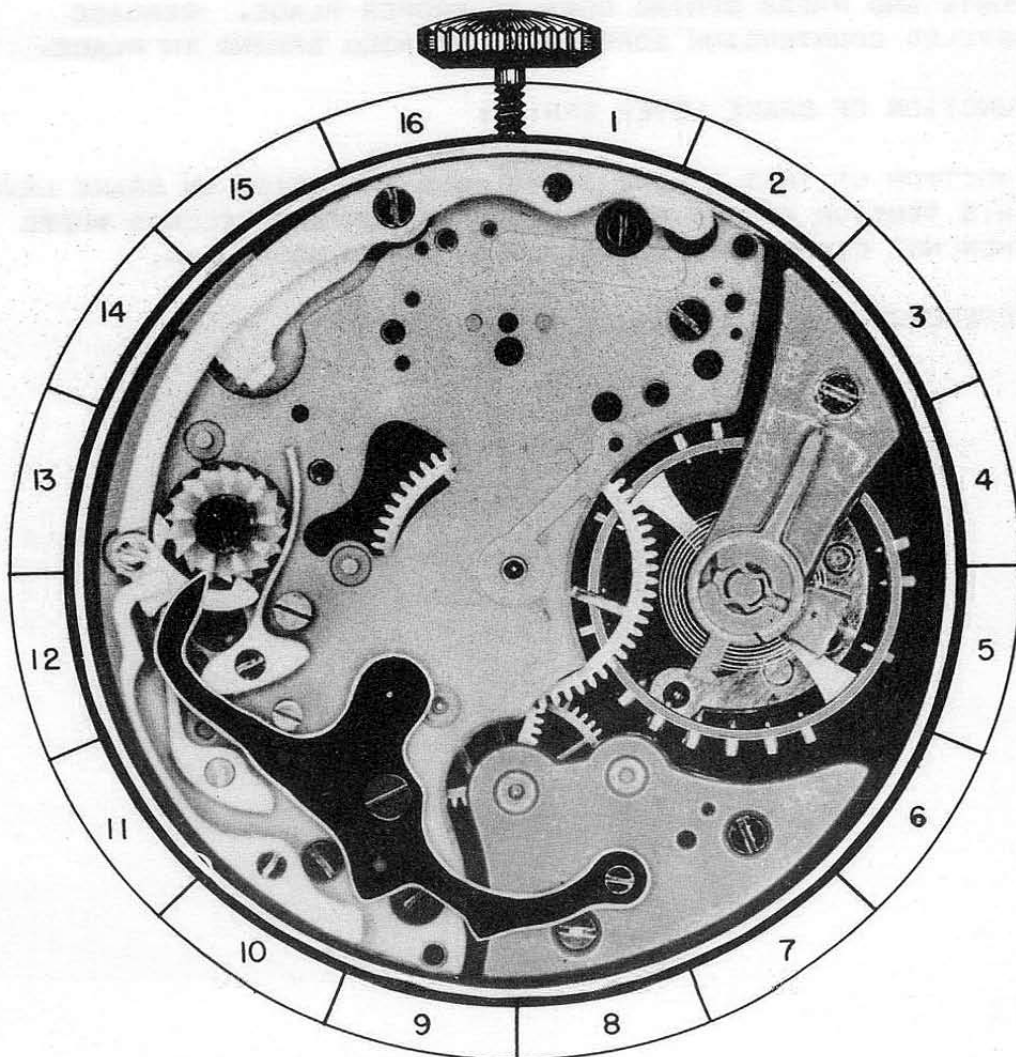

15 - A

PART NO. 16

A. DISASSEMBLY PROCEDURE OF BRAKE LEVER SPRING:

THIS SPRING IS HELD IN PLACE BY BEVELED COUNTERSINK SCREW BS-5 AND STEADY PINS. SLIDE A THIN BLADE SCREWDRIVER UNDER SPRING TO LOOSEN IT FROM PLATE. WHEN STEADY PINS ARE FREE IN PLATE, SPRING MAY BE LIFTED FROM MOVEMENT.

(THE SHAPE OF SCREW FOR THIS PART IS SHOWN AT BOTTOM OF PAGE)

B. HAZARDS IN DISASSEMBLY OF BRAKE LEVER SPRING:

WHEN LOOSENING SPRING FROM PLATE, THE SCREWDRIVER SHOULD BE CAREFULLY USED TO PREVENT MARRING OF SPRING OR PLATE.

C. ASSEMBLY PROCEDURE OF BRAKE LEVER SPRING:

PLACE SPRING ON PLATE WITH STEADY PINS OVER PROPER HOLES IN PLATE AND PRESS SPRING DOWN TO PROPER PLACE. REPLACE BEVELED COUNTERSINK SCREW BS-5 TO HOLD SPRING IN PLACE.

D. FUNCTION OF BRAKE LEVER SPRING:

FUNCTION OF THIS SPRING IS TO HOLD A TENSION ON BRAKE LEVER. THIS TENSION FORCES BRAKE LEVER TO CONTACT SECONDS WHEEL WHEN NOT DISENGAGED BY THE CHRONOGRAPH MECHANISM.

REFERENCE: SECONDS WHEEL IS ASSEMBLY 5

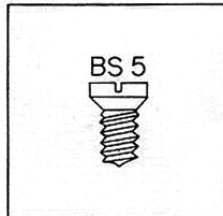

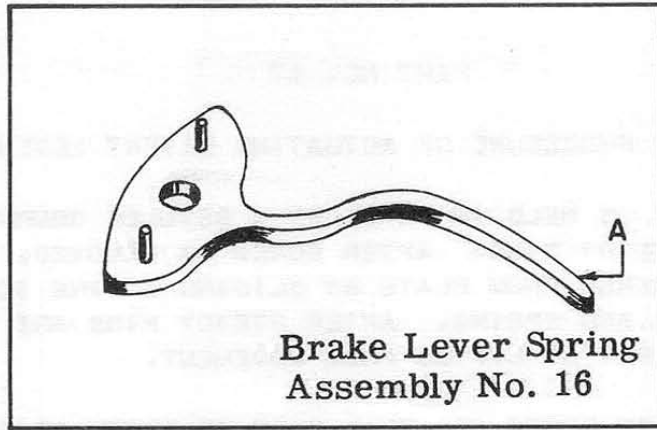

Brake Lever Spring
Assembly No. 16

OILING

The brake lever spring should be oiled after brake lever is replaced.

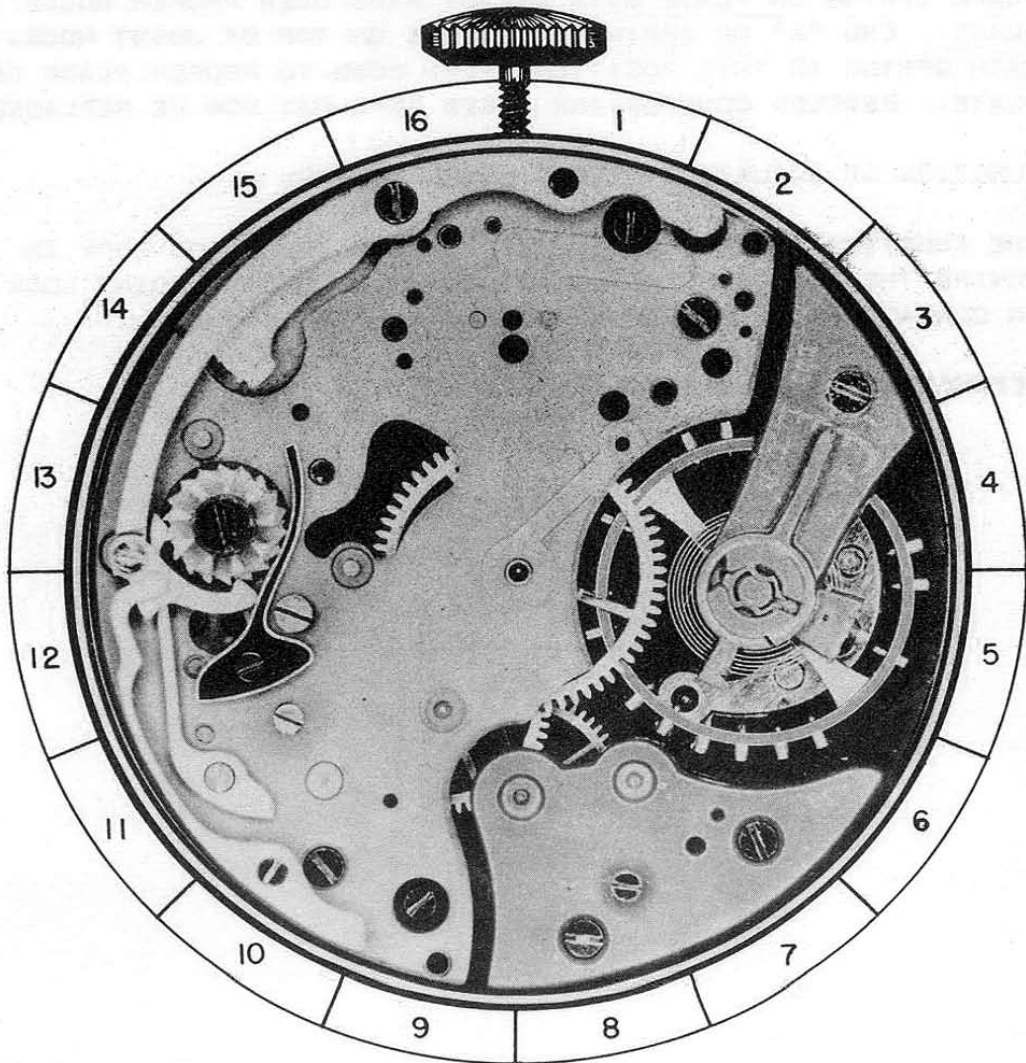

16 - A

PART NO. 17

A. DISASSEMBLY PROCEDURE OF ACTUATING DETENT LEVER SPRING:

THIS SPRING IS HELD IN PLACE BY A BEVELED COUNTERSINK SCREW BS-6 AND STEADY PINS. AFTER SCREW IS REMOVED, THE SPRING MAY BE LOOSENED FROM PLATE BY SLIDING A FINE SCREWDRIVER BETWEEN PLATE AND SPRING. AFTER STEADY PINS ARE FREE IN PLATE, THE SPRING MAY BE LIFTED FROM MOVEMENT.

(THE SHAPE OF SCREW FOR THIS PART IS SHOWN AT BOTTOM OF PAGE)

B. HAZARDS IN DISASSEMBLY OF DETENT LEVER SPRING:

HOLD FINGER OVER SPRING WHEN REMOVING SCREW SO THAT SPRING OR SCREW DOES NOT SHOOT AWAY.

C. ASSEMBLY PROCEDURE OF ACTUATING DETENT LEVER SPRING:

PLACE SPRING ON PLATE WITH STEADY PINS OVER PROPER HOLES IN PLATE. END "A" OF SPRING SHOULD BE ON TOP OF JOINT HOOK. WITH SPRING IN THIS POSITION, PUSH DOWN TO PROPER PLACE ON PLATE. BEVELED COUNTERSINK SCREW BS-6 MAY NOW BE REPLACED.

D. FUNCTION OF ACTUATING DETENT LEVER SPRING:

THE FUNCTION OF THIS SPRING IS TO MOVE THE JOINT HOOK IN TOWARD THE CENTER OF WATCH; ALSO, IT HOLDS THE JOINT HOOK IN CONTACT WITH THE RATCHET TEETH ON CASTLE WHEEL.

REFERENCE: CASTLE WHEEL IS ASSEMBLY 22
JOINT HOOK IS ASSEMBLY 18

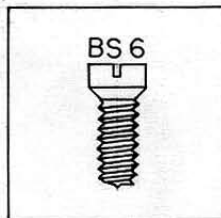

Actuating Detent Lever Spring
Assembly No. 17

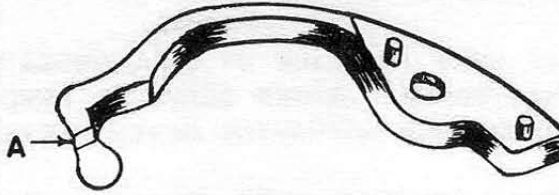

OILING

End "A" of actuating detent lever spring should be slightly moistened with oil. At the point it contacts joint hook.

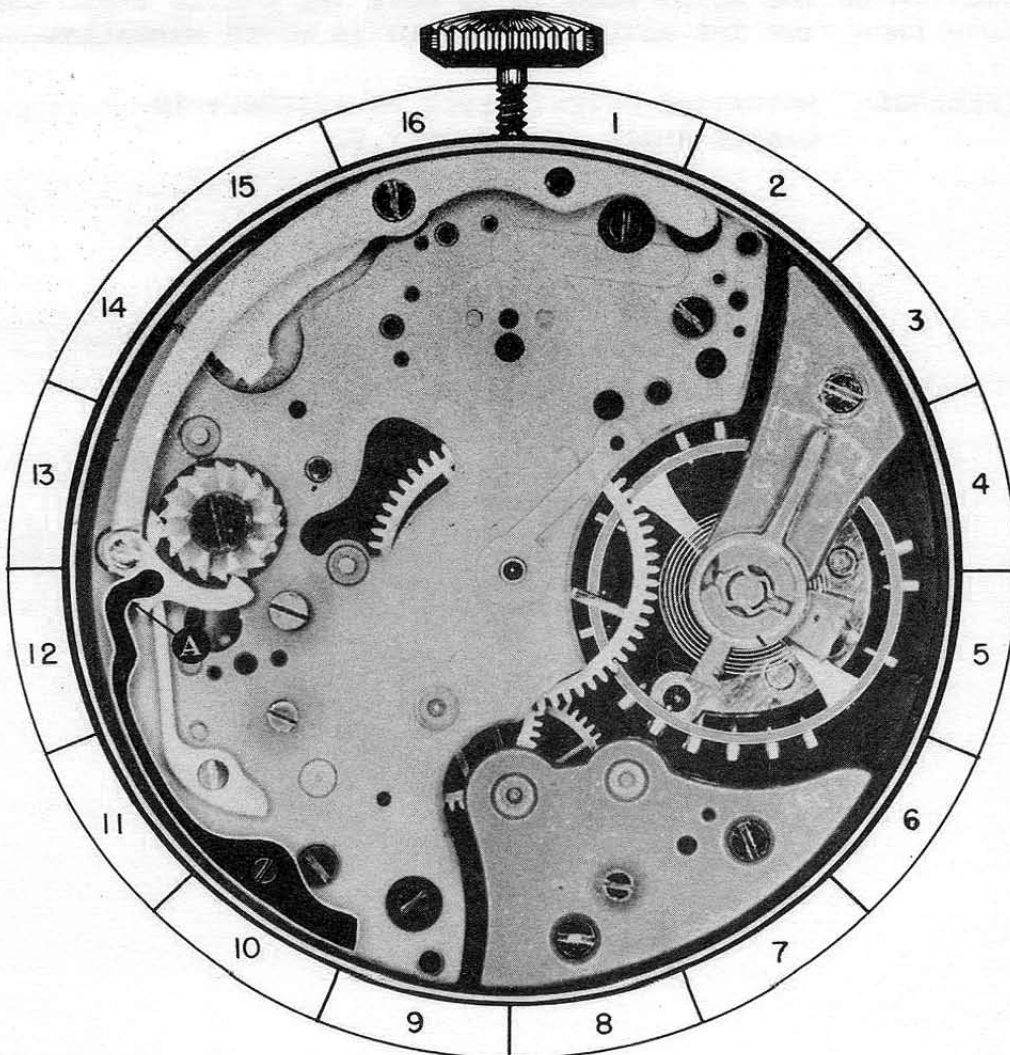

17 - A

PART NO. 18

A. DISASSEMBLY PROCEDURE OF JOINT HOOK:

THE JOINT HOOK IS HELD IN PLACE BY SHOULDERED SCREW SS-3 AND PIVOTS ON THIS SCREW. AFTER SCREW IS REMOVED, THE JOINT HOOK MAY BE REMOVED FROM ACTUATING DETENT LEVER.

(THE SHAPE OF SCREW FOR THIS PART IS SHOWN AT BOTTOM OF PAGE)

B. ASSEMBLY PROCEDURE OF JOINT HOOK:

THE JOINT HOOK IS PLACED IN POSITION ON END OF ACTUATING DETENT LEVER. REPLACE SHOULDERED SCREW SS-3 TO HOLD JOINT HOOK TO ACTUATING LEVER. JOINT HOOK MUST TURN FREELY UNDER HEAD OF SCREW.

C. FUNCTION OF THE JOINT HOOK:

FUNCTION OF THE JOINT HOOK IS TO MOVE THE CASTLE WHEEL ONE TOOTH EACH TIME THE ACTUATING DETENT IS MOVED MANUALLY.

REFERENCE: ACTUATING DETENT LEVER IS ASSEMBLY 19
CASTLE WHEEL IS ASSEMBLY 22

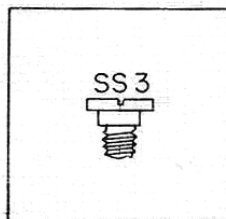

**Joint Hook
Assembly No. 18**

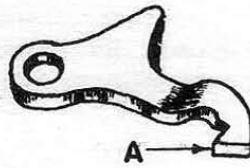

OILING

The shouldered screw that joint hook pivots on should be slightly moistened with oil.

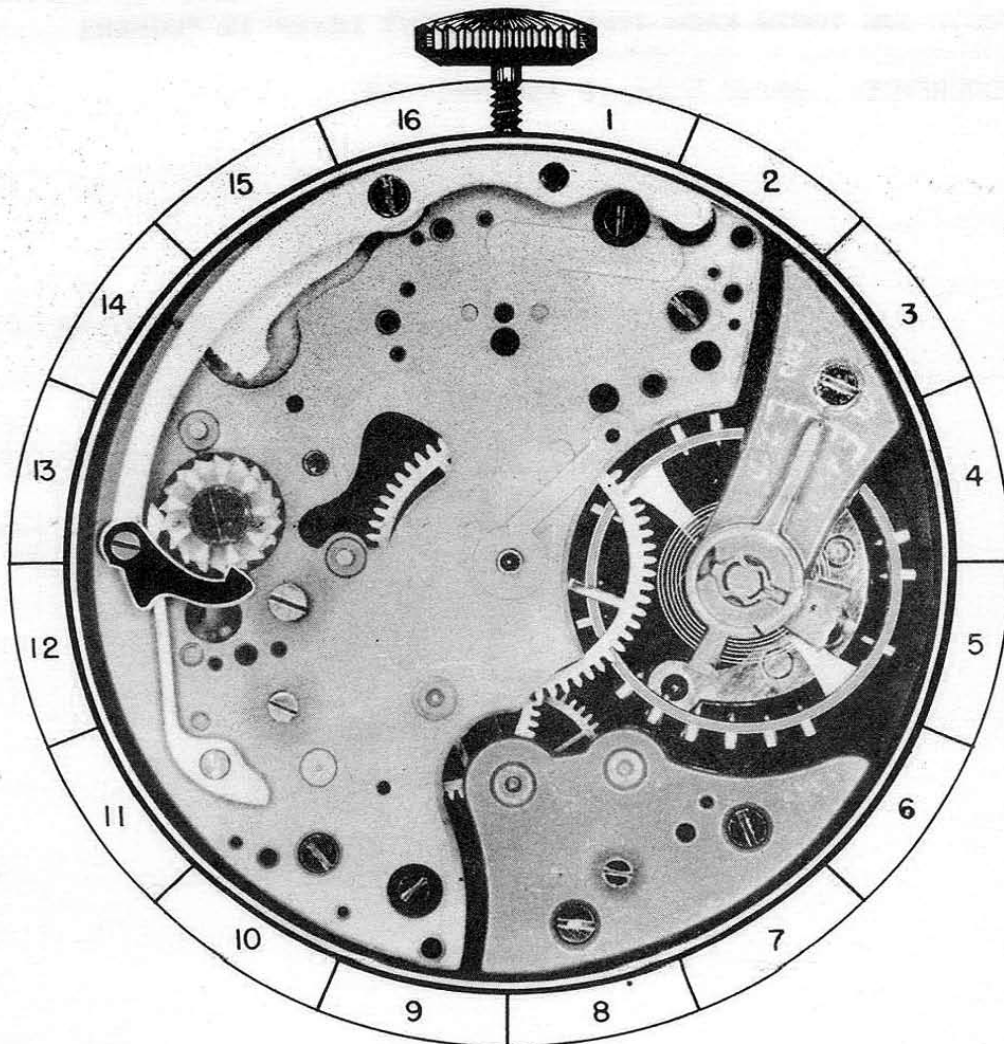

18 - A

PART NO. 19

A. DISASSEMBLY PROCEDURE OF ACTUATING DETENT LEVER:

THIS LEVER IS HELD IN PLACE BY SHOULDERED SCREW SS-4 AND PIVOTS ON THIS SCREW. REMOVE SCREW AND LIFT LEVER FROM PLATE.

(THE SHAPE OF SCREW FOR THIS PART IS SHOWN AT BOTTOM OF PAGE)

B. ASSEMBLY PROCEDURE OF ACTUATING DETENT LEVER:

THE ACTUATING DETENT IS PLACED IN PROPER POSITION ON PLATE AS SHOWN IN PICTURE AND SHOULDERED SCREW SS-4 REPLACED. THE DETENT SHOULD PIVOT FREELY UNDER HEAD OF SCREW.

C. FUNCTION OF ACTUATING DETENT LEVER:

THE FUNCTION OF ACTUATING DETENT LEVER IS TO MOVE THE JOINT HOOK AWAY FROM THE CENTER OF WATCH. THIS TURNS THE CASTLE WHEEL ONE TOOTH EACH TIME THE DETENT LEVER IS PUSHED.

REFERENCE: JOINT HOOK IS ASSEMBLY 18

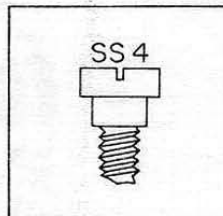

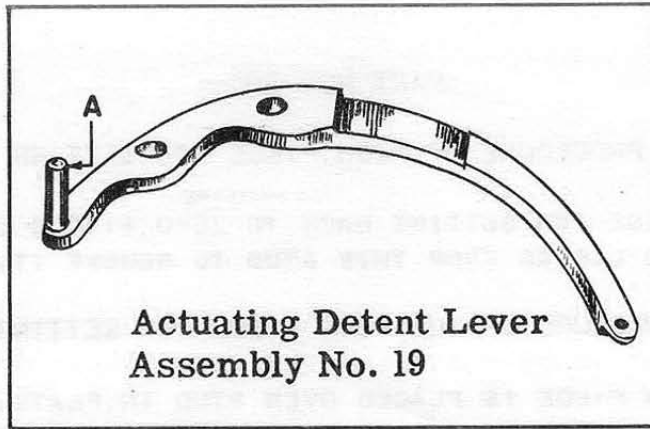

Actuating Detent Lever
Assembly No. 19

OILING

The shouldered screw that actuating detent lever pivots on should be slightly moistened with oil.

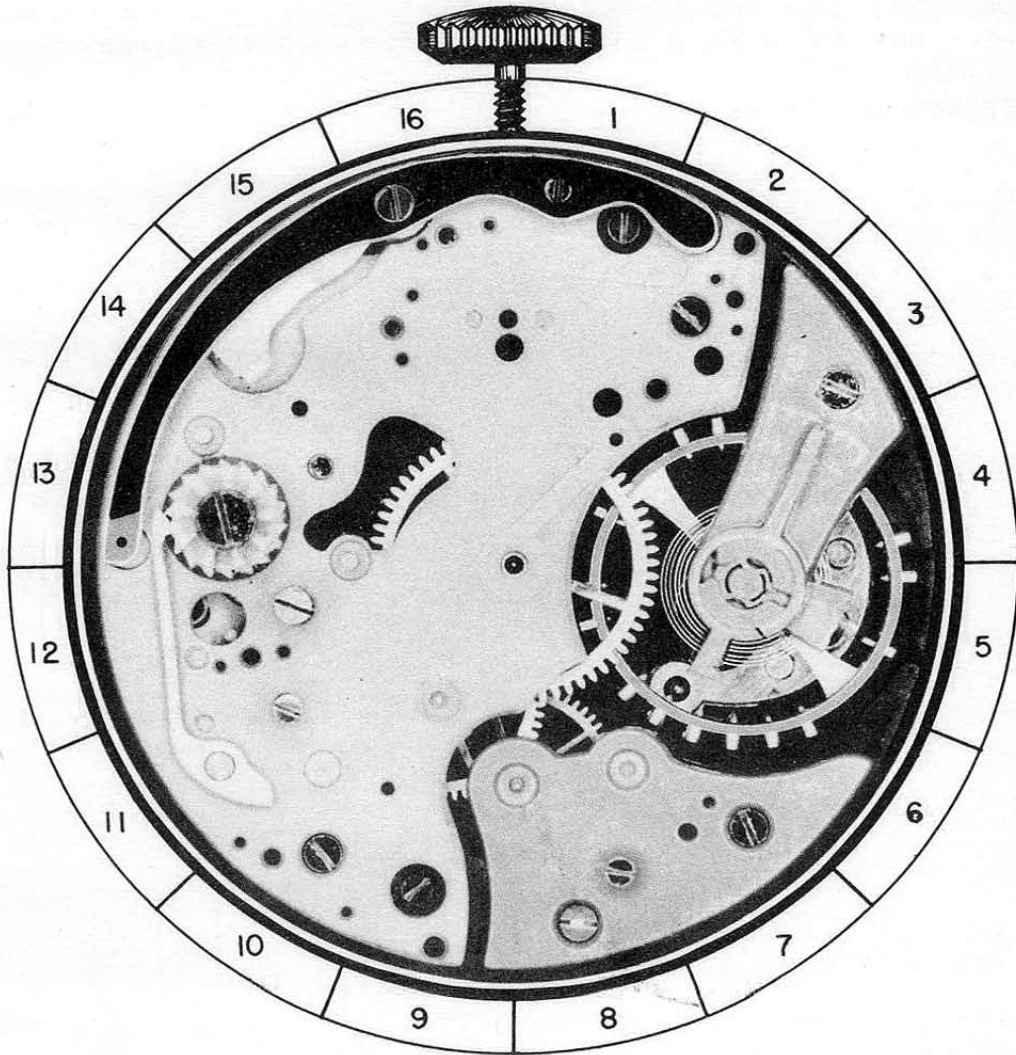

19 - A

PART NO. 20

A. DISASSEMBLY PROCEDURE OF PUSH PIECE FOR SETTING BACK TO ZERO:

THE PUSH PIECE FOR SETTING BACK TO ZERO PIVOTS ON STUD IN PLATE AND IS LIFTED FROM THIS STUD TO REMOVE IT.

B. ASSEMBLY PROCEDURE OF THE PUSH PIECE FOR SETTING BACK TO ZERO:

HOLE IN PUSH PIECE IS PLACED OVER STUD IN PLATE. THE SCREW TO HOLD PUSH PIECE IN PLACE IS REPLACED AFTER REPLACING ACTUATING DETENT LEVER AS THE SAME SCREW HOLDS BOTH PARTS IN PLACE.

C. FUNCTION OF PUSH PIECE FOR SETTING BACK TO ZERO:

FUNCTION OF THIS PUSH PIECE IS WHEN PUSHED TO MOVE THE FLY-BACK LEVER IN TOWARD THE CENTER OF WATCH.

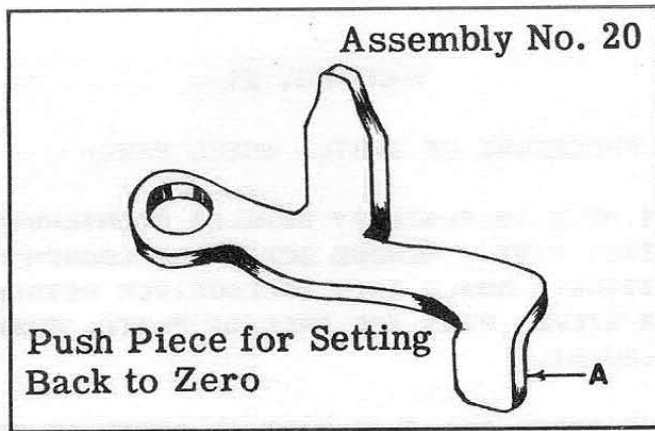

OILING

The stud that push piece for setting back to zero turns on should be slightly moistened with oil.

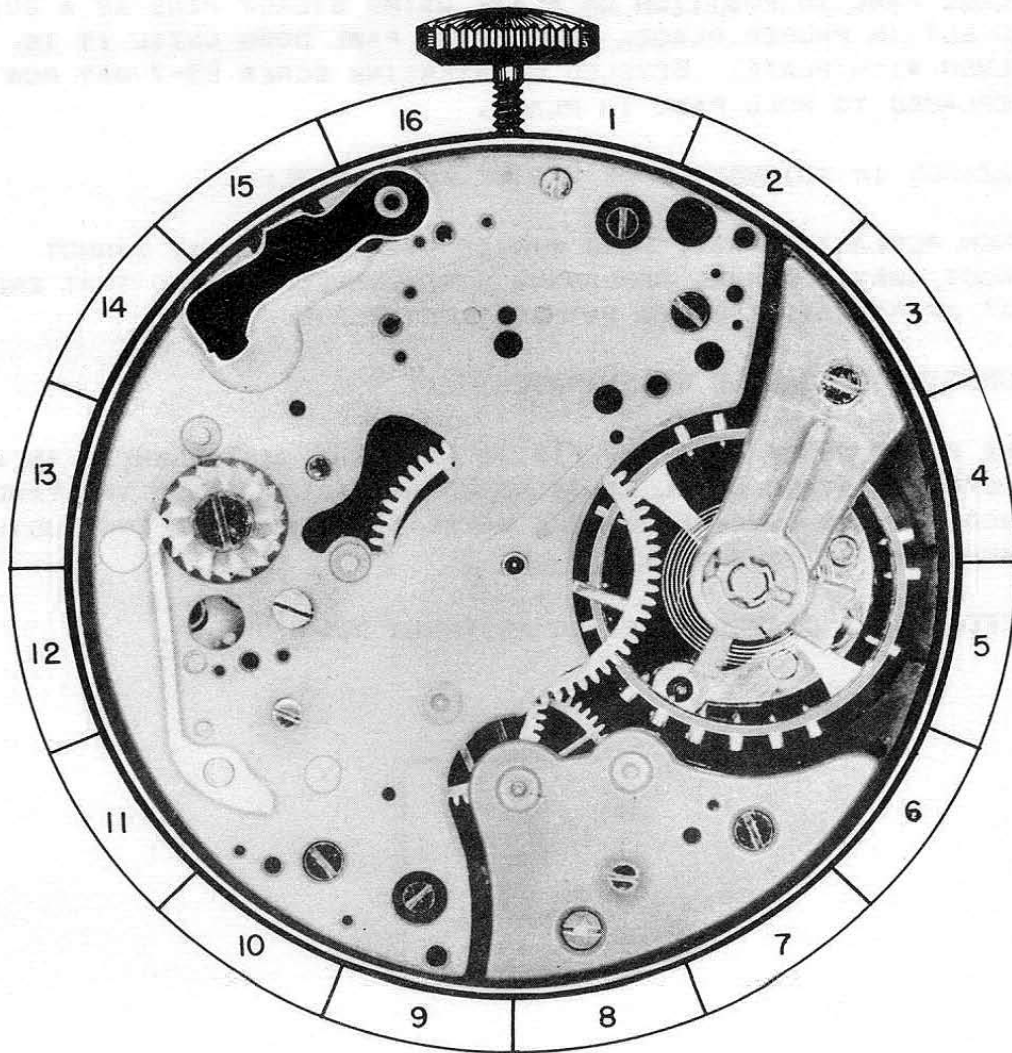

20 - A

PART NO. 21

A. DISASSEMBLY PROCEDURE OF CASTLE WHEEL PAWL:

THIS PAWL IS HELD IN PLACE BY BEVELED COUNTERSINK SCREW BS-7 AND STEADY PINS. REMOVE SCREW AND LOOSEN PAWL FROM PLATE BY SLIDING A SMALL THIN SCREWDRIVER BETWEEN PLATE AND PAWL. AFTER STEADY PINS ARE FREE OF PLATE, PAWL MAY BE LIFTED FROM MOVEMENT.

(THE SHAPE OF SCREW FOR THIS PART IS SHOWN AT BOTTOM OF PAGE)

B. HAZARDS IN DISASSEMBLY OF CASTLE WHEEL PAWL:

WHEN REMOVING SCREW, HOLD FINGER OVER PAWL SO THERE IS NO DANGER OF PAWL OR SCREW SHOOTING AWAY.

C. ASSEMBLY PROCEDURE OF CASTLE WHEEL PAWL:

PLACE PAWL IN POSITION ON PLATE USING STEADY PINS AS A GUIDE TO SET IN PROPER PLACE. THEN PUSH PAWL DOWN UNTIL IT IS FLUSH WITH PLATE. BEVELED COUNTERSINK SCREW BS-7 MAY NOW BE REPLACED TO HOLD PAWL IN PLACE.

D. HAZARDS IN ASSEMBLING OF CASTLE WHEEL PAWL:

WHEN REPLACING PAWL, HOLD FINGER OVER PAWL SO IT CANNOT SHOOT AWAY. BEFORE REPLACING SCREW, CHECK TO SEE THAT END "A" OF PAWL IS ENGAGED WITH RATCHET TEETH.

E. FUNCTION OF CASTLE WHEEL PAWL:

THE FUNCTION OF THIS PAWL IS TO HOLD THE CASTLE WHEEL IN ITS PROPER POSITION UNTIL IT IS MOVED MANUALLY. ALSO THE PAWL IS USED TO MAKE SURE THE CASTLE WHEEL TURNS EXACTLY ONE TOOTH EACH TIME IT IS MOVED.

REFERENCE: CASTLE WHEEL IS ASSEMBLY 22.

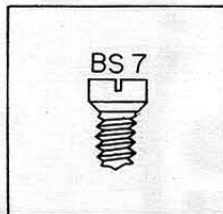

Castle Wheel Pawl
Assembly No. 21

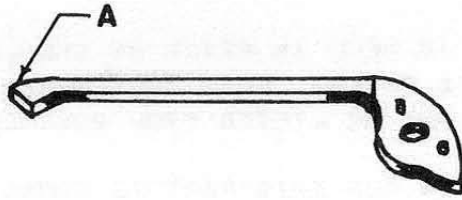

OILING

The castle wheel pawl should not be oiled.

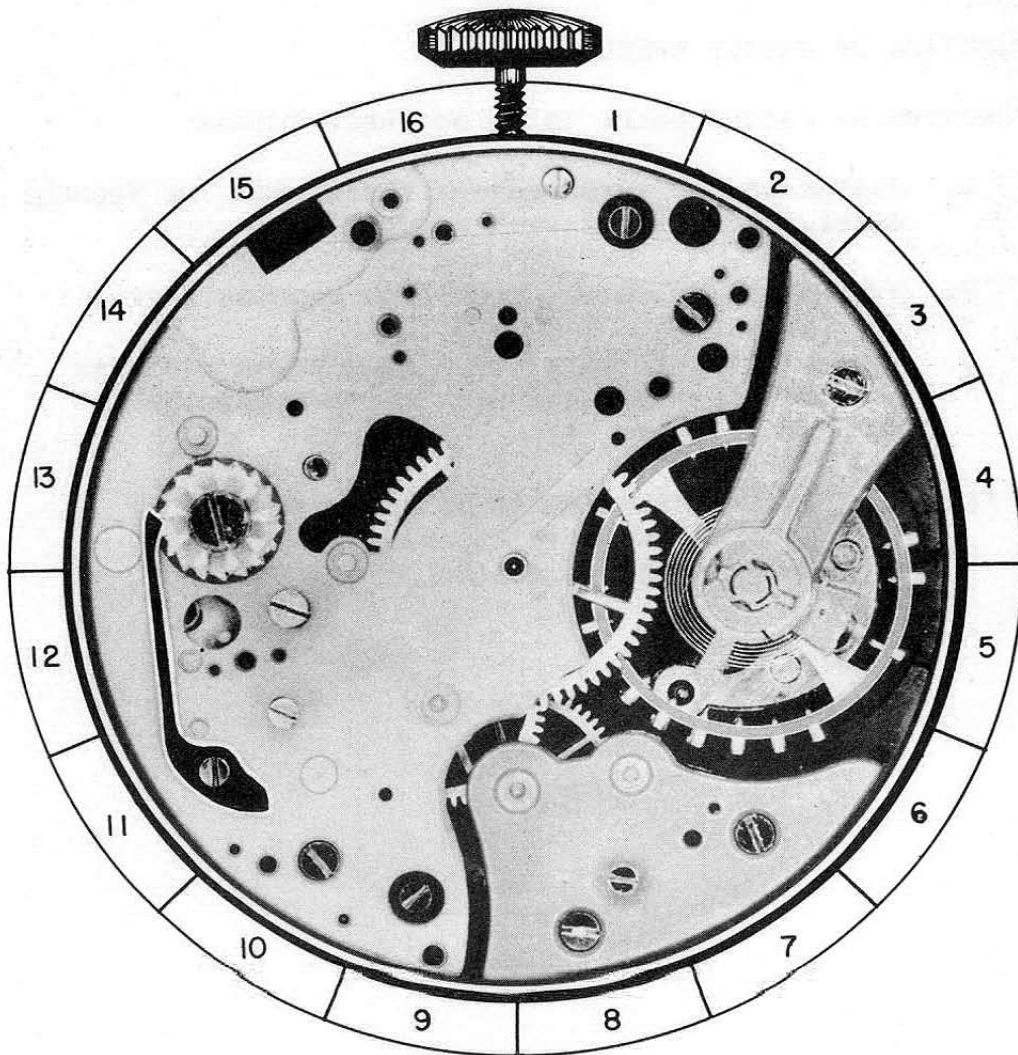

21 - A

PART NO. 22

A. DISASSEMBLY PROCEDURE OF THE CASTLE WHEEL:

THE CASTLE WHEEL IS HELD IN PLACE BY SHOULDERED SCREW SS-5 AND PIVOTS ON THIS SCREW. WHEN SHOULDERED SCREW IS REMOVED, THE CASTLE WHEEL MAY BE LIFTED FROM MOVEMENT.

(THE SHAPE OF SCREW FOR THIS PART IS SHOWN AT BOTTOM OF PAGE)

B. ASSEMBLY PROCEDURE OF CASTLE WHEEL:

PLACE CASTLE WHEEL IN ITS PROPER POSITION ON PLATE AND REPLACE SHOULDERED SCREW SS-5. THE CASTLE WHEEL SHOULD TURN EASILY UNDER THE HEAD OF SCREW AND YET NOT HAVE EXCESS FREEDOM.

C. HAZARDS IN ASSEMBLING OF CASTLE WHEEL:

THE PLATE AND WHEEL SHOULD BE EXAMINED FOR BURRS THAT COULD PREVENT IT FROM TURNING FREELY.

D. FUNCTION OF CASTLE WHEEL:

FUNCTION OF CASTLE WHEEL IS TO DO THREE THINGS:

1. DISENGAGE THE INTERMEDIARY WHEEL FROM THE SECONDS WHEEL.
2. DISENGAGE THE BRAKE LEVER FROM SECONDS WHEEL.
3. PREVENTS THE FLYBACK LEVER FROM BEING MOVED TO CENTER OF WATCH WHEN CHRONOGRAPH MECHANISM IS ENGAGED.

REFERENCE: INTERMEDIARY WHEEL IS ASSEMBLY 13
SECONDS WHEEL IS ASSEMBLY 5
BRAKE LEVER IS ASSEMBLY 16

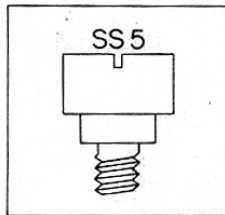

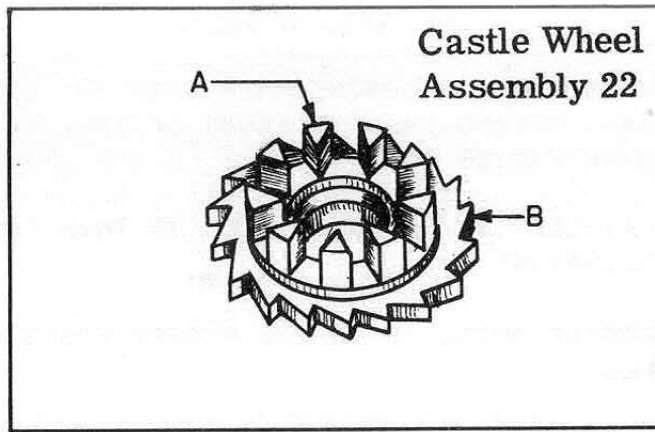

OILING

These parts of castle wheel should be slightly moistened with oil.

1. The shouldered screw that castle wheel pivots on.
2. The columns 'A' on castle wheel at the points they contact the parts of this mechanism.
3. The ratchet teeth B on castle wheel should be slightly moistened with oil.

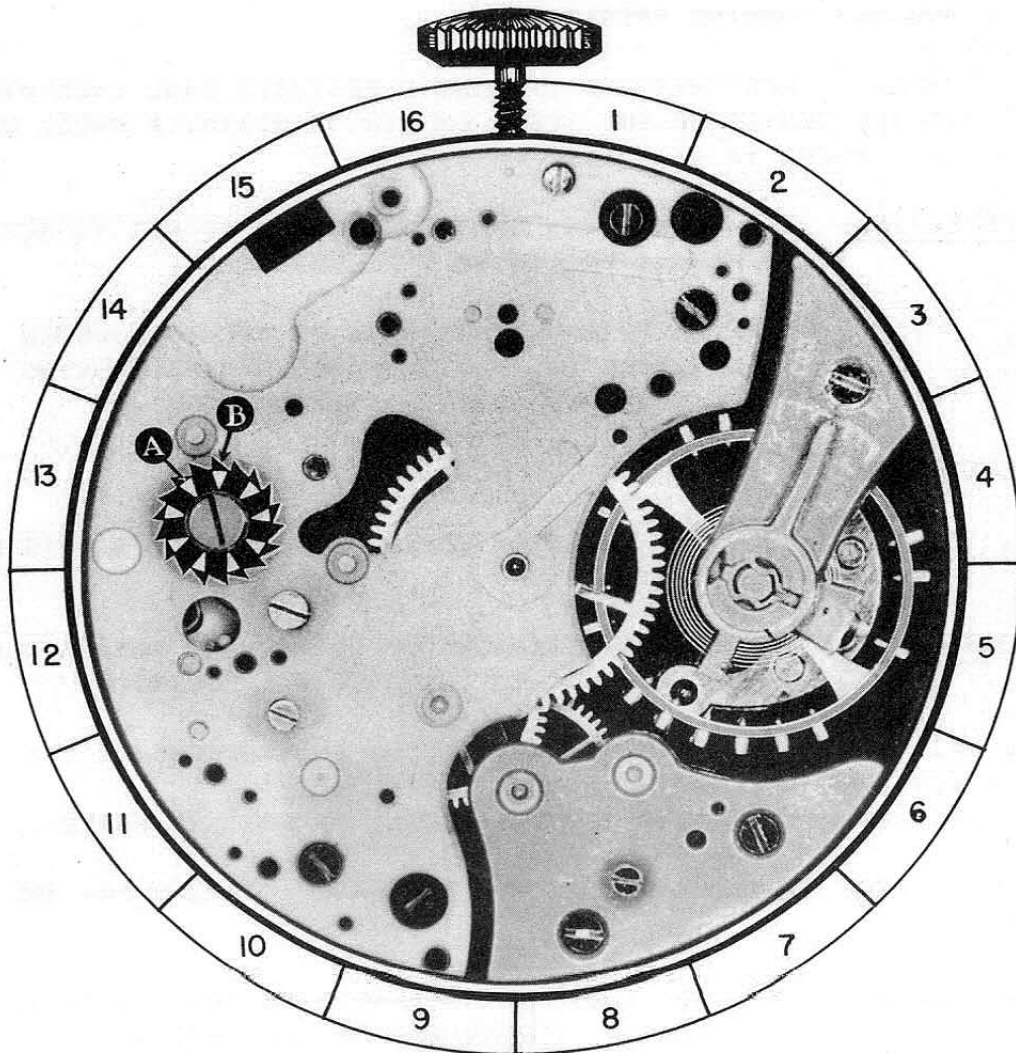

22 - A

FUNCTIONAL RESULTS

AFTER COMPLETELY ASSEMBLING CHRONOGRAPH WITH THE EXCEPTION OF BACK OF CASE, PLACE CHRONOGRAPH IN FRONT OF YOU, PENDANT UP WITH BACK OF CHRONOGRAPH FACING YOU.

1. PUSH BUTTON AT LEFT OF PENDANT, HOLD IN THIS POSITION AND CHECK THE FOLLOWING:

(MAKE SURE CASTLE WHEEL IS IN THE PROPER POSITION SO BUTTON CAN BE PUSHED)

- A. CHECK TO SEE THAT SECONDS WHEEL AND MINUTE REGISTER WHEEL RETURN THE HANDS CONNECTED TO THESE WHEELS TO A ZERO POSITION.

CORRECTION: THE FOLLOWING ERRORS COULD PREVENT THESE HANDS FROM RETURNING TO ZERO POSITION.

1. LOOSE HANDS OR HANDS NOT BEING SET CORRECTLY.
 2. THE MINUTE REGISTER WHEEL OR THE SECONDS WHEEL BINDING AND NOT TURNING FREELY.
- B. CHECK TO SEE THAT END OF MINUTE REGISTER PAWL LIES DIRECTLY IN THE CENTER OF TWO TEETH ON MINUTE REGISTER WHEEL WHEN THIS WHEEL IS AT A ZERO POSITION.

CORRECTION: THE PAWL BEING BENT WILL CAUSE IT NOT TO SET CORRECTLY ON MINUTE REGISTER WHEEL.

FAILURE TO HAVE THIS PAWL PROPERLY ADJUSTED WILL RESULT IN MINUTE REGISTER WHEEL MOVING AFTER FLY BACK MOVES AWAY FROM HEART.

2. RELEASE BUTTON AND CHECK THE FOLLOWING:

- A. CHECK TO SEE THAT FLY BACK LEVER RETURNS TO ITS ORIGINAL POSITION.

CORRECTION: THE FOLLOWING ERRORS COULD PREVENT FLY BACK LEVER FROM RETURNING TO ITS ORIGINAL POSITION.

1. FLY BACK LEVER SPRING NOT HOLDING ENOUGH TENSION ON FLY BACK LEVER.
 2. FLY BACK LEVER NOT TURNING FREELY ON POST IN PLATE.
3. PUSH BUTTON AT RIGHT OF PENDANT, RELEASE IT AND CHECK THE FOLLOWING:

- A. CHECK DEPTHING OF TEETH ON INTERMEDIARY WHEEL WITH TEETH ON SECONDS WHEEL. (CONTINUED ON NEXT PAGE)

FUNCTIONAL RESULTS
(CONTINUED)

CORRECTION: THE FOLLOWING ERRORS COULD PREVENT CORRECT DEPTHING OF THESE TEETH.

1. CHRONOGRAPH PIVOTED DETENT SPRING NOT HOLDING ENOUGH TENSION ON CHRONOGRAPH PIVOTED DETENT.
2. CHRONOGRAPH PIVOTED DETENT NOT TURNING FREELY.
3. IMPROPERLY ADJUSTED ECCENTRIC STUDS COULD PREVENT THE PROPER DEPTHING OF THESE WHEELS.
(SEE ADJUSTMENT OF ECCENTRIC STUDS IN FRONT OF BOOK)

- B. CHECK DEPTHING OF SECONDS WHEEL DART TOOTH WITH INTERMITTENT WHEEL TEETH.

CORRECTION: THE FOLLOWING ERRORS COULD PREVENT PROPER DEPTHING OF DART TOOTH WITH INTERMITTENT WHEEL TEETH.

1. INTERMITTENT LEVER NOT TURNING FREELY ON POST IN PLATE.
2. IMPROPERLY ADJUSTED ECCENTRIC STUD COULD PREVENT PROPER DEPTHING OF THESE PARTS.
(SEE ADJUSTMENT OF ECCENTRIC STUDS IN FRONT OF BOOK)

REMARKS: IF THE DEPTHING OF THE INTERMITTENT WHEEL TEETH WITH THE SECONDS WHEEL DART TOOTH IS DEEP, THE MINUTE REGISTER WHEEL MAY MOVE TWO TEETH EACH TIME THE SECONDS WHEEL MAKES ONE REVOLUTION.

IF THE DEPTHING IS SHALLOW IT MAY CAUSE THE MINUTE REGISTER WHEEL NOT TO MOVE A FULL TOOTH AND THUS WILL NOT REGISTER THE MINUTES ON DIAL.

- C. CHECK TO SEE THAT SECONDS HAND MOVES FORWARD IN A STEADY MANNER WITH NO JUMPING OR JERKING.

CORRECTION: THIS IRREGULAR MOVEMENT OF THE SECONDS HAND IS USUALLY CAUSED BY THE SECONDS WHEEL TENSION SPRING NOT HOLDING ENOUGH TENSION ON SECONDS WHEEL

4. PUSH BUTTON AT RIGHT OF PENDANT A SECOND TIME, RELEASE IT AND CHECK THE FOLLOWING:
 - A. CHECK TO SEE THAT BRAKE LEVER IS IN CONTACT WITH SECONDS WHEEL.

CORRECTION: THE FOLLOWING ERRORS COULD PREVENT BRAKE LEVER CONTACTING SECONDS WHEEL.

1. BRAKE LEVER NOT TURNING FREELY UNDER HEAD OF SCREW.
2. BRAKE LEVER SPRING NOT HOLDING ENOUGH TENSION ON BRAKE LEVER.

DIRECTIONS FOR READING CHRONOGRAPH DIAL

THE TACHOMETER

- A. The tachometer is used to indicate the speed of an object in miles per hour. A tachometer can only indicate the average speed of an object traveling over a course of a measured mile.

METHOD OF USING TACHOMETER

1. Start chronograph sweep second hand at the exact moment the object starts to travel the measured distance of one mile.
2. When the object has traveled the course of one mile, stop the chronograph at the point on the tachometer scale where the sweep second hand stopped. It will indicate the average speed in miles per hour.

SPLIT SECOND SCALE

- B. This scale is divided into 300 divisions. Each indicating $1/5$ of a second every fifth division is marked with extra long lines denoting one second.

The main purpose of this scale is to measure a fraction of a second accurately.

SECOND HAND

- C. The second hand indicates the passing of seconds and should move one space each second. One complete revolution of hand denotes passage of one minute. This hand is independent of chronograph mechanism and continues to register the seconds as long as watch is running.

TELEMETER

- D. The telemeter is used to denote the number of miles between two points. This is done by comparing the speed of light to the speed of sound.

METHOD OF USING TELEMETER

1. Start chronograph sweep second hand when you see lightning.
2. Stop the chronograph sweep second hand when you hear the thunder. The point on the telemeter scale where the sweep second hand stopped will indicate the distance in miles the lightning is away from you.

MINUTE REGISTER

- E. The minute register hand registers the number of minutes the chronograph has been in operation. This hand should move forward one space each minute that the chronograph is in operation.

THE CHRONOGRAPH DIAL

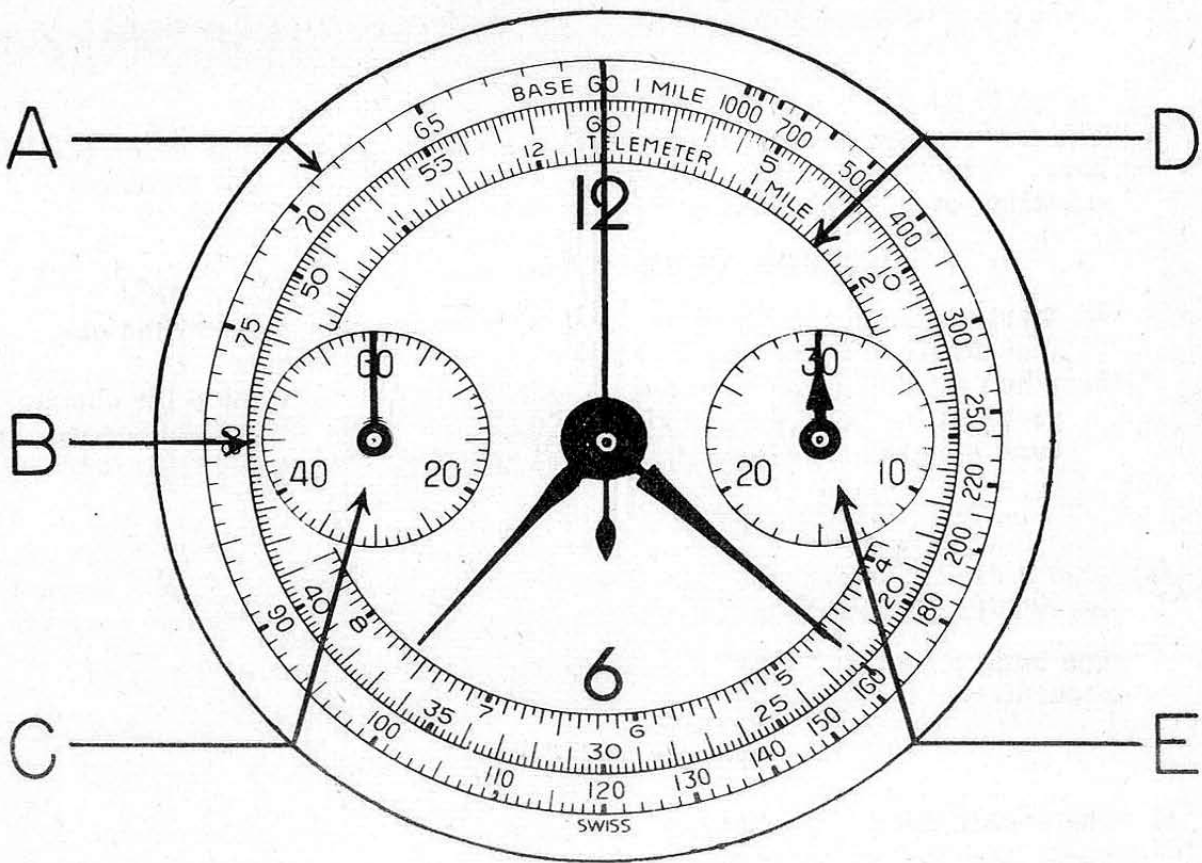

SETTING THE HANDS CORRECTLY ON A CHRONOGRAPH:

After the chronograph is completely assembled and in working condition, place chronograph in its case. Now replace the hands, replace the hour hand, minute hand and second hand as you would on a regular watch. At this point, do not replace the sweep second or the minute register hand. Now push the button and bring the flyback lever in toward the center of the watch. When the flyback lever is held in toward the center of the watch, place the sweep second hand at 60 on split second scale 'B'. Place the minute register hand at 30 on minute register scale 'E'. After these hands are replaced, start chronograph mechanism with sweep second hand turning. Leave chronograph mechanism run for at least one minute, now push the button to bring the flyback lever in toward the center of the watch again, and check to see that the minute register hand and the sweep second hand goes back to their original position.