

# IDENTIFICATION OF CHRONOGRAPH



13'''



VALJOUX  
CAL. 72-C

## INSTRUCTIONS

For use of book

### DISASSEMBLY OF THE CHRONOGRAPH MECHANISM:

1. Study the isometric drawing at top of page 1-A. The isometric drawing was made for the following purposes:
  - A. It helps to identify the part to be removed.
  - B. This drawing aids in pointing out certain locations on the part that are mentioned in the oiling procedure.
  - C. The text refers to certain points on the part. These points are shown in the isometric drawing. This should aid you in finding the exact location on the part that is described in the text.
  - D. It helps you to know the shape of the part in case a new part has to be made.
2. At the bottom of the page 1-A is a photograph of a chronograph. In this photograph is the same part painted in black. The part is in its exact location that this part occupies in the watch. Find this location in the watch.
3. Read the disassembly procedure and the hazards in disassembly on page 1 in this book.
4. Remove this part in the same procedure as described in the text.
5. A very important item in disassembling a chronograph is keeping the screws in order, much time will be lost in putting the chronograph together if screws are mixed up. This means you have to hunt for each screw, sometimes trying three or four screws before finding the correct one. It cannot be stressed too strongly that care should be taken so that screws are not mixed up. The system that we advise for beginners, is to replace each individual screw after each part is removed. This naturally eliminates the hazard of mixing up the screws and will save you much time in the end. Do this at least until you become so thoroughly familiar with the chronograph that you no longer feel it is necessary.
6. Continue to follow this procedure throughout the book and disassemble each part until the last part of the chronograph is removed.

### ASSEMBLY OF THE CHRONOGRAPH MECHANISM:

7. When you are ready to assemble the chronograph mechanism, study the isometric drawing on the last part in this book. This drawing should aid you in identifying the part to be assembled.
8. At the bottom of this page is a photograph of a chronograph. In this photograph is the same part painted in black. The part is in its exact location that this part occupies in the watch.
9. Read the assembly procedure and the hazards in assembling for the last part in this book. (Continued on next page)

## INSTRUCTIONS (Continued)

10. Replace the part in its exact location as shown in photograph, using the procedure as described in the text.

11. After you find the correct location for this part in the watch, read the oiling procedure for this part. The oiling procedure for this part is located underneath the isometric drawing. It is best to read the oiling procedure before you put each part in place as there are certain parts that must be oiled immediately as it may prove difficult to oil them later.

12. Replace the screw that holds this part in place. Of course, the screws should be kept in order as we advised above, but if the screws are not in order or the watch was received with screws mixed up, you will find a screw drawn for each part that requires a screw at the bottom of the text page.

13. After replacing this part, replace the next part, etc., until the last part is replaced, which will be part No. 1. Each part should be replaced using the same procedure as described in the text.

(Naturally, the assembly of the chronograph is exactly the reverse of the disassembly)

14. After disassembling and assembling the chronograph mechanism, start on page 1 and read the function of this part. After reading the function of this part, continue to read the function of each part throughout the book. Study each part, one at a time. This text should help you to understand more fully the purpose of each part in the chronograph mechanism.

15. Now put movement in its case with dial on, then replace hands.

16. Study the text on functional results in this book, and check the chronograph mechanism as described in this text.

### NOMENCLATURE OF PARTS FOR CHRONOGRAPH MECHANISM







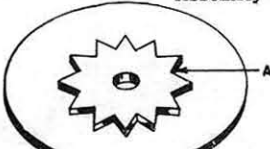
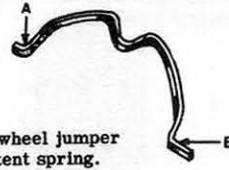
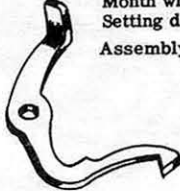
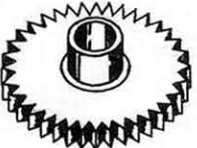
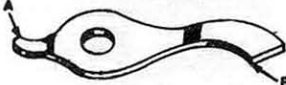

17. After you have become familiar with the chronograph mechanism, you can disassemble and assemble the chronograph by using the nomenclature of parts as a guide. This makes it possible for you to use a procedure without going through each page in the book.

#### 18. ADJUSTMENT OF ECCENTRIC STUDS:

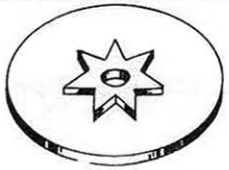
Read the text on adjustment of eccentric studs, this text should be read in reference to the eccentric stud picture. Now adjust each eccentric stud one at a time in the watch, as described in the text. Use the picture to show you the position of these studs.

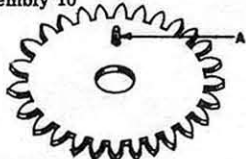
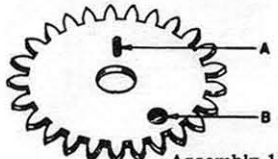

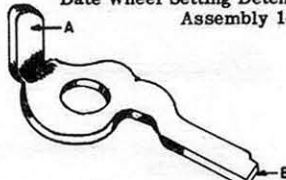
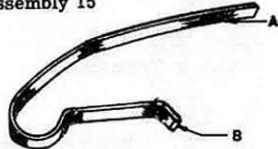
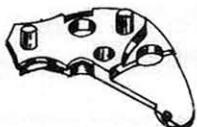

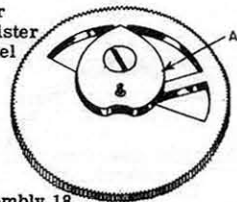
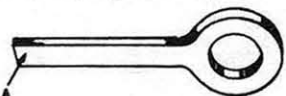
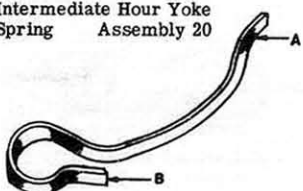





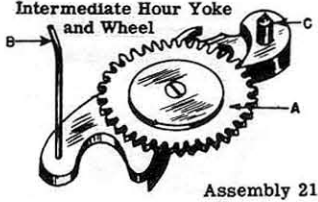

19. On each page in this book the part number and the page number are the same. This makes it convenient for the reader and eliminates any confusion.

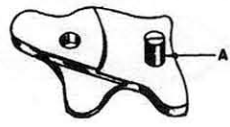
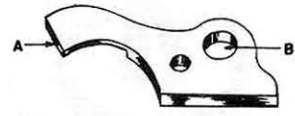
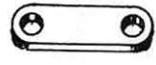
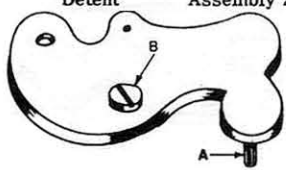
# NOMENCLATURE OF PARTS FOR CHRONOGRAPH MECHANISM

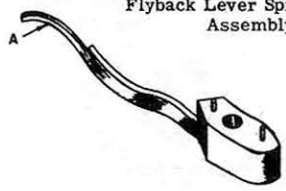
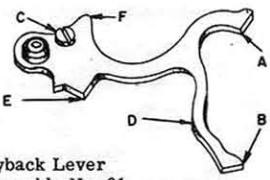
<p>Assembly 1.</p>  <p>The star wheel of months</p>	 <p>Month wheel jumper and detent spring. Assembly 2.</p>	 <p>Month wheel Setting detent Assembly 3.</p>
<p>Date Wheel Assembly 4</p> 	<p>Date Wheel Jumper Assembly 5</p> 	<p>Date Wheel Jumper Spring Assembly 6</p> 
<p>Star Wheel Of Days Assembly 7</p> 	<p>Days Wheel Jumper Assembly 8</p> 	<p>Days Wheel Jumper Spring Assembly 9</p> 
<p>Intermediate Days Wheel Assembly 10</p> 	<p>Intermediate Date Wheel Assembly 11</p> 	<p>Hour wheel with hairing wheel Assembly 12</p> 
<p>Cannon Pinion Assembly 13</p> 	<p>Date Wheel Setting Detent Assembly 14</p> 	<p>Date Wheel Setting Detent Spring Assembly 15</p> 
<p>Hour Register Wheel Bridge Assembly 16</p> 	<p>Hour Register Wheel Tension Spring Assembly 17</p> 	<p>Hour Register Wheel Assembly 18</p> 
<p>Intermediate Hour Wheel Tension Spring Assembly 19</p> 	<p>Intermediate Hour Yoke Spring Assembly 20</p> 	

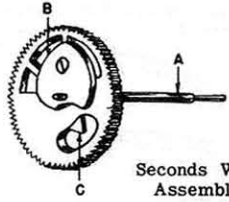

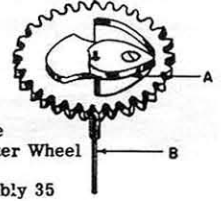

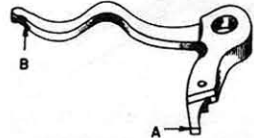
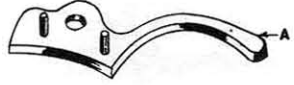
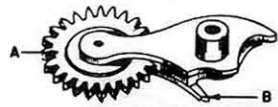
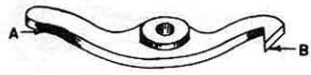





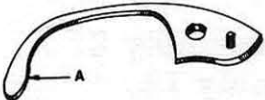
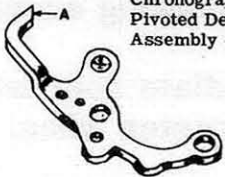

Continued on the next page

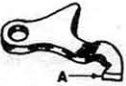
# NOMENCLATURE OF PARTS FOR CHRONOGRAPH MECHANISM

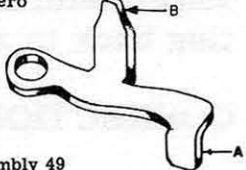
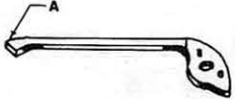
 <p>Intermediate Hour Yoke and Wheel Assembly 21</p>	 <p>Transmission pinion Assembly 22.</p>	 <p>Hour Flyback Detent Assembly 23</p>
 <p>Hour Flyback Spring Assembly 24</p>	 <p>Hour Flyback Lever Bridge Assembly 25</p>	 <p>Hour Flyback Lever Assembly 26</p>
 <p>Articulation Arm Assembly 27</p>	 <p>Intermediate Hour Flyback Detent Assembly 28</p>	 <p>Wheel Over Fourth Wheel Assembly 29</p>
 <p>Flyback Lever Spring Assembly 30</p>	 <p>Flyback Lever Assembly No. 31</p>	 <p>Seconds Wheel and Minute Register Wheel Bridge Assembly 32</p>
 <p>Seconds Wheel Assembly 33.</p>	 <p>Seconds Wheel Tension Spring Assembly 34</p>	 <p>Minute Register Wheel Assembly 35</p>
 <p>Minute Register Pawl Assembly 36</p>	 <p>Brake Lever Assembly 37.</p>	 <p>Intermittent Lever Spring Assembly 38</p>
 <p>Intermittent Lever and Wheel Assembly Assembly 39</p>		 <p>Lever Arm Hour Yoke Assembly 40</p>

Continued on the next page

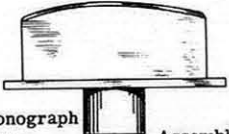
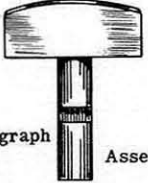
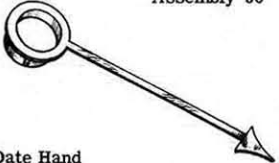
# NOMENCLATURE OF PARTS FOR CHRONOGRAPH MECHANISM

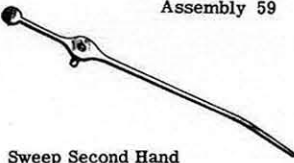
 Brake Lever Spring Assembly 41	Chronograph Pivoted Detent Bridge.  Assembly 42	Intermediary wheel Assembly 43.  Assembly 43
Chronograph Pivoted Detent Spring  Assembly 44	Chronograph Pivoted Detent Assembly 45  Assembly 45	Actuating Detent Lever Spring Assembly 46  Assembly 46
Joint Hook Assembly 47  Assembly 47	Actuating Detent Lever Assembly 48  Assembly 48	Push Piece for Setting Back To Zero  Assembly 49
Castle Wheel Pawl Assembly 50  Assembly 50	Castle Wheel Assembly 51  Assembly 51	Date Pusher Assembly 52  Assembly 52
Month Pusher Assembly 53  Assembly 53	Chronograph Button  Assembly 54	Chronograph Button  Assembly 55
Assembly 56  Date Hand	Assembly 57  Numerator Hour Hand	Assembly 58  Minute Register Hand
Assembly 59  Sweep Second Hand		

## ADJUSTMENT OF ECCENTRIC STUDS - DIAL SIDE

Listed below are a number of depthings and adjustments controlled by the eccentric studs.

1. Check the depthing of the hour register wheel teeth with the pinion leaves on the intermediate hour wheel, when these wheels are engaged.

**CORRECTION:** If this depthing is incorrect, it can be corrected by adjusting eccentric stud ES-4.

**REFERENCE:** Intermediate hour wheel is Assembly 21 A.  
Hour register wheel is Assembly 18.

2. Check to see that the seconds wheel and the hour register wheel returns to a zero position, when the push piece for setting back to zero is pushed.

**CORRECTION:** If one of these wheels do not return to a zero position when the push piece is pushed, this condition can be corrected by adjusting eccentric stud ES-5.

**REFERENCE:** Seconds wheel is Assembly 33.  
Hour register wheel is Assembly 18.  
Push piece for setting back to zero is  
Assembly 49.

# ADJUSTING ECCENTRIC STUDS

DO NOT REMOVE THESE STUDS  
DIAL SIDE

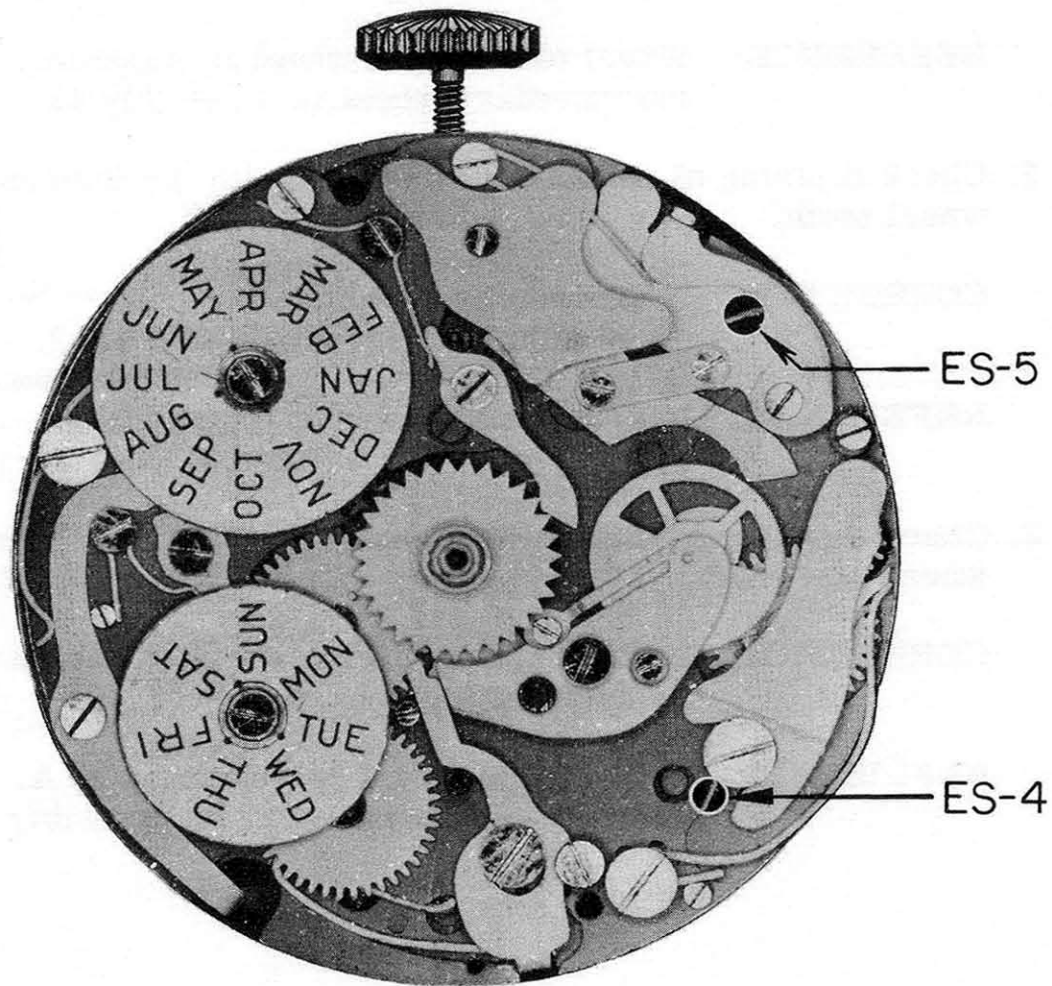

## CAUTION

In disassembling or assembling chronograph it is a good policy not to turn the eccentric studs. These eccentric studs are used to adjust one part to another, and, naturally, in turning these studs, you will lose the desired adjustment of the chronograph mechanism, which will cause the chronograph to function incorrectly. Another reason for not turning these studs, unless it is necessary, is, that they soon become loose and will not hold the desired adjustment.



## ADJUSTMENT OF ECCENTRIC STUDS - TRAIN SIDE

Listed below are a number of depthings and adjustments controlled by the eccentric studs.

1. Check the depthing of the wheel over fourth wheel teeth with the intermediary wheel teeth.

**CORRECTION:** If this depthing is incorrect, it can be corrected by adjusting eccentric stud ES-1.

**REFERENCE:** Wheel over fourth wheel is Assembly 29.  
Intermediary wheel is Assembly 43.

2. Check depthing of seconds wheel teeth with the intermediary wheel teeth.

**CORRECTION:** If this depthing is incorrect, it can be corrected by adjusting eccentric stud ES-2.

**REFERENCE:** Intermediary wheel is Assembly 43.  
Seconds wheel is Assembly 33.

3. Check depthing of intermittent wheel teeth with the seconds wheel dart tooth.

**CORRECTION:** If this depthing is incorrect, it can be corrected by adjusting eccentric stud ES-3.

**REFERENCE:** Intermittent wheel is Assembly 39 A.  
Seconds wheel dart tooth is Assembly 33 C.

# ADJUSTING ECCENTRIC STUDS

DO NOT REMOVE THESE STUDS  
TRAIN SIDE

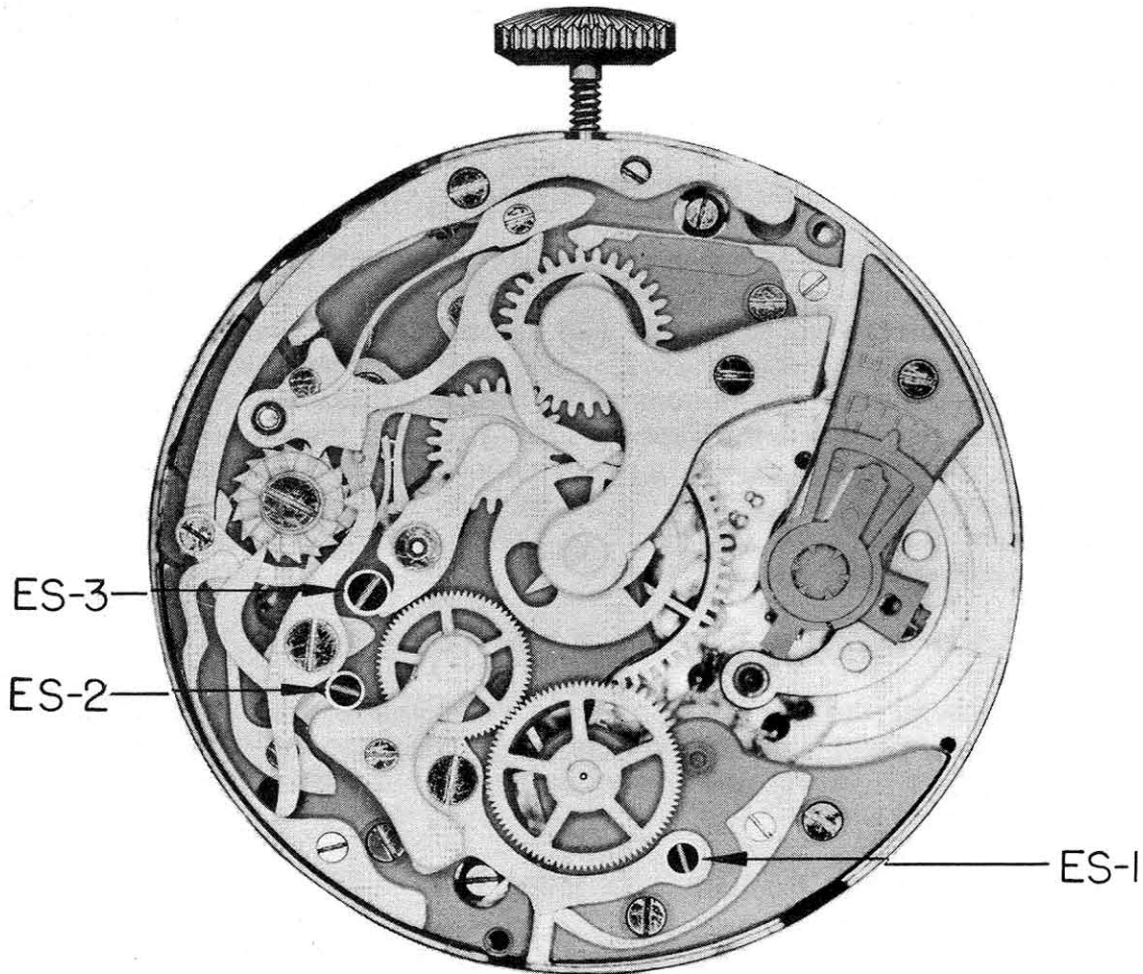

## CAUTION

In disassembling or assembling chronograph it is a good policy not to turn the eccentric studs. These eccentric studs are used to adjust one part to another, and, naturally, in turning these studs, you will lose the desired adjustment of the chronograph mechanism, which will cause the chronograph to function incorrectly. Another reason for not turning these studs, unless it is necessary, is, that they soon become loose and will not hold the desired adjustment.

**A. DISASSEMBLY PROCEDURE OF STAR WHEEL OF MONTHS:**

The star wheel of months is held in place by shouldered screw SS-1 and pivots on this screw. After screw is removed, the wheel may be lifted from the plate.

(The shape of screw for this part is shown at bottom of the page.)

**B. HAZARDS IN DISASSEMBLY OF STAR WHEEL OF MONTHS:**

Hold finger over star wheel when removing screw, so that screw or wheel does not shoot away. The dial on this wheel is very easily scratched. Care should be taken so that a slight slip of the screwdriver or tweezers does not damage the dial.

**C. ASSEMBLY PROCEDURE OF STAR WHEEL OF MONTHS:**

Place the star wheel of months in position on the plate with the hole in the wheel over the proper screw hole. Place a screwdriver at location "C" on the month wheel jumper and detent spring. Location "C" is shown in the photograph. Now apply pressure at location "C" in the direction away from the center of the watch. This will force the end "B" of the jumper from under the star of month wheel, permitting this wheel to set on the plate in its proper position. End "B" of jumper spring is shown in the isometric drawing on Page 2. Now replace shouldered screw SS-1 and check to see that the star wheel of months is not binding under head of screw.

**D. HAZARDS IN ASSEMBLY OF STAR WHEEL OF MONTHS:**

When replacing the star wheel of months, check to see that end "B" of the month wheel jumper and detent spring is not under the star of the wheel. Also, while replacing the screw, use care not to scratch the dial of this wheel.

**E. FUNCTION OF STAR WHEEL OF MONTHS:**

The function of this wheel is to register the months. This wheel is not controlled by calendar mechanism, but is manually controlled.

**REFERENCE:** Month wheel jumper and detent spring is Assembly 2.

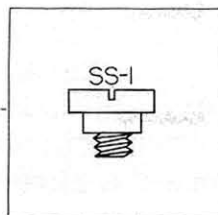

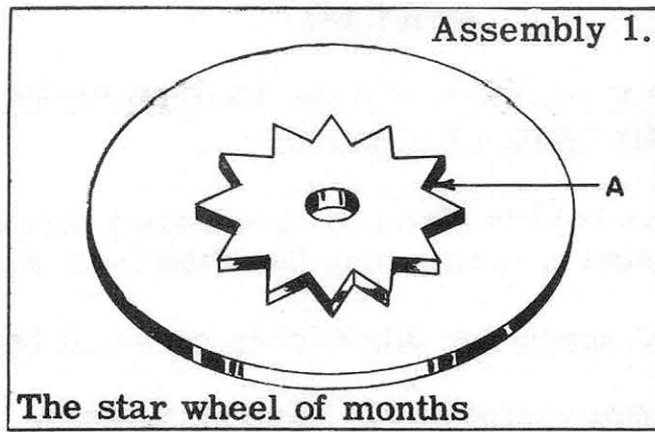

### OILING

The star wheel of months should not be oiled.

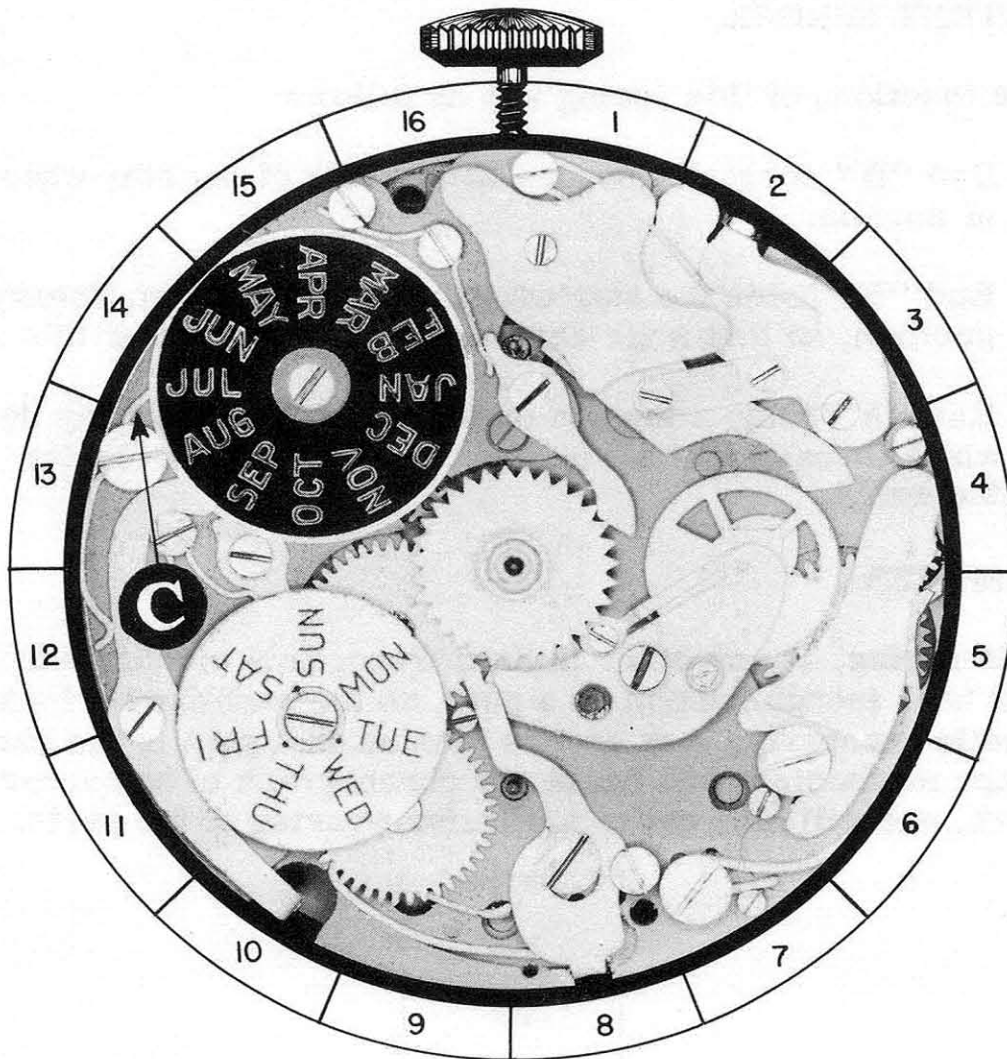

**A. DISASSEMBLY PROCEDURE OF MONTH WHEEL JUMPER AND DETENT SPRING:**

This spring is held in place by shouldered screw SS-2. When screw is removed, spring may be lifted from plate.

(The shape of screw for this part is shown at bottom of page.)

**B. ASSEMBLY PROCEDURE OF MONTH WHEEL JUMPER AND DETENT SPRING:**

Place the spring in position, with end "A" on the outside of the month wheel setting detent. Now replace the shouldered screw SS-2, which holds this spring in place.

**C. FUNCTION OF MONTH WHEEL JUMPER AND DETENT SPRING:**

The functions of this spring are as follows:

1. End "B" correctly spaces the turning of the star wheel of months.
2. End "B" holds the star wheel of months in a stationary position, so that a jar cannot alter the position of this wheel.
3. End "A" holds a tension on the month wheel setting detent, which forces end "A" of this detent toward the center of the watch.

**REMARKS:**

This spring, as any other in the chronograph mechanism, should just hold enough tension on a part, so the part can perform its function properly. Any excess tension on a part in the chronograph mechanism will cause the chronograph to be harder to work, and will also cause excessive wearing of the parts.

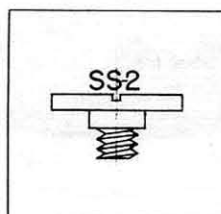

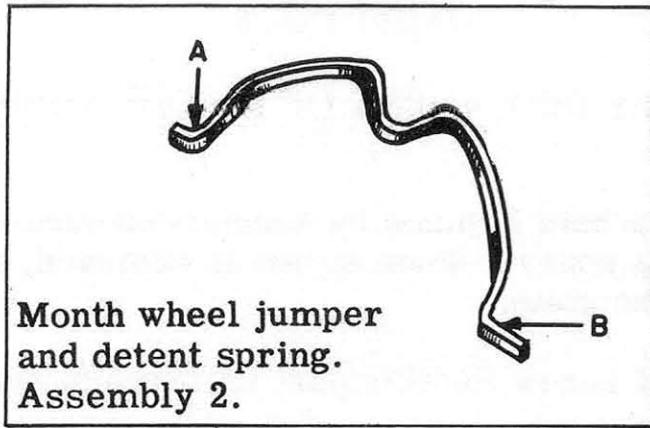

### OILING

End "A" of the month wheel jumper and detent spring should be slightly moistened with oil at point of contact with the month wheel setting detent.

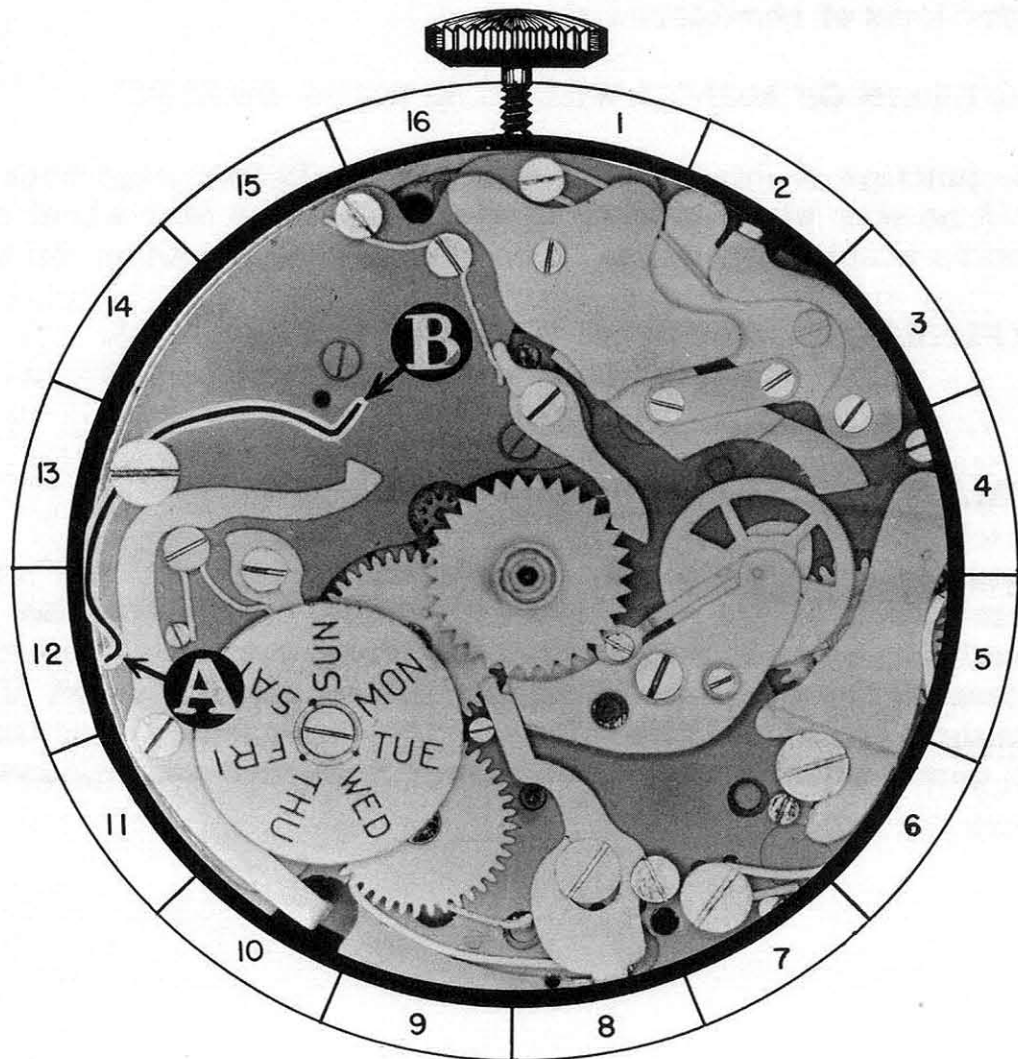

**A. DISASSEMBLY PROCEDURE OF MONTH WHEEL SETTING DETENT:**

This detent is held in place by shouldered screw SS-3, and pivots on this screw. When screw is removed, detent may be lifted from the plate.

(The shape of screw for this part is shown at bottom of page.)

**B. ASSEMBLY PROCEDURE OF MONTH WHEEL SETTING DETENT:**

Place the month wheel setting detent in position on the plate, with hole in detent over proper screw hole, as shown in the photograph. Now replace shouldered screw SS-3, which holds this detent in place. Check detent to see that it moves freely under head of shouldered screw.

**C. FUNCTION OF MONTH WHEEL SETTING DETENT:**

The function of this detent, when pushed, is to engage with teeth on star wheel of months and to move the star wheel of months exactly one tooth. This changes the month on the dial.

**REFERENCE:** Star wheel of months is Assembly 1.  
Month wheel jumper and detent spring is Assembly 2.

**REMARKS:**

When the month wheel setting detent is pushed, end "A" contacts a tooth on the star wheel of months, forcing the star wheel of months to rotate slightly. When the setting detent is released, the month wheel jumper forces the star wheel of months to rotate a little further. This is repeated each time the month wheel setting detent lever is pushed and released.

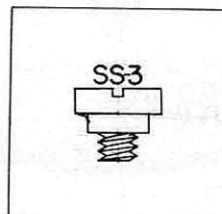

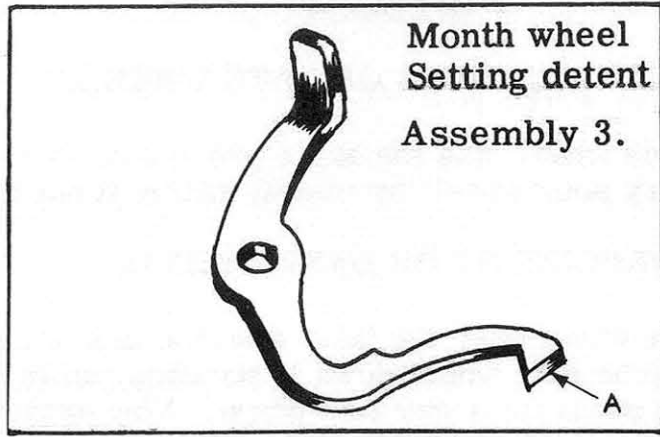

### OILING

The shouldered screw, that month wheel setting detent pivots on, should be slightly moistened with oil.

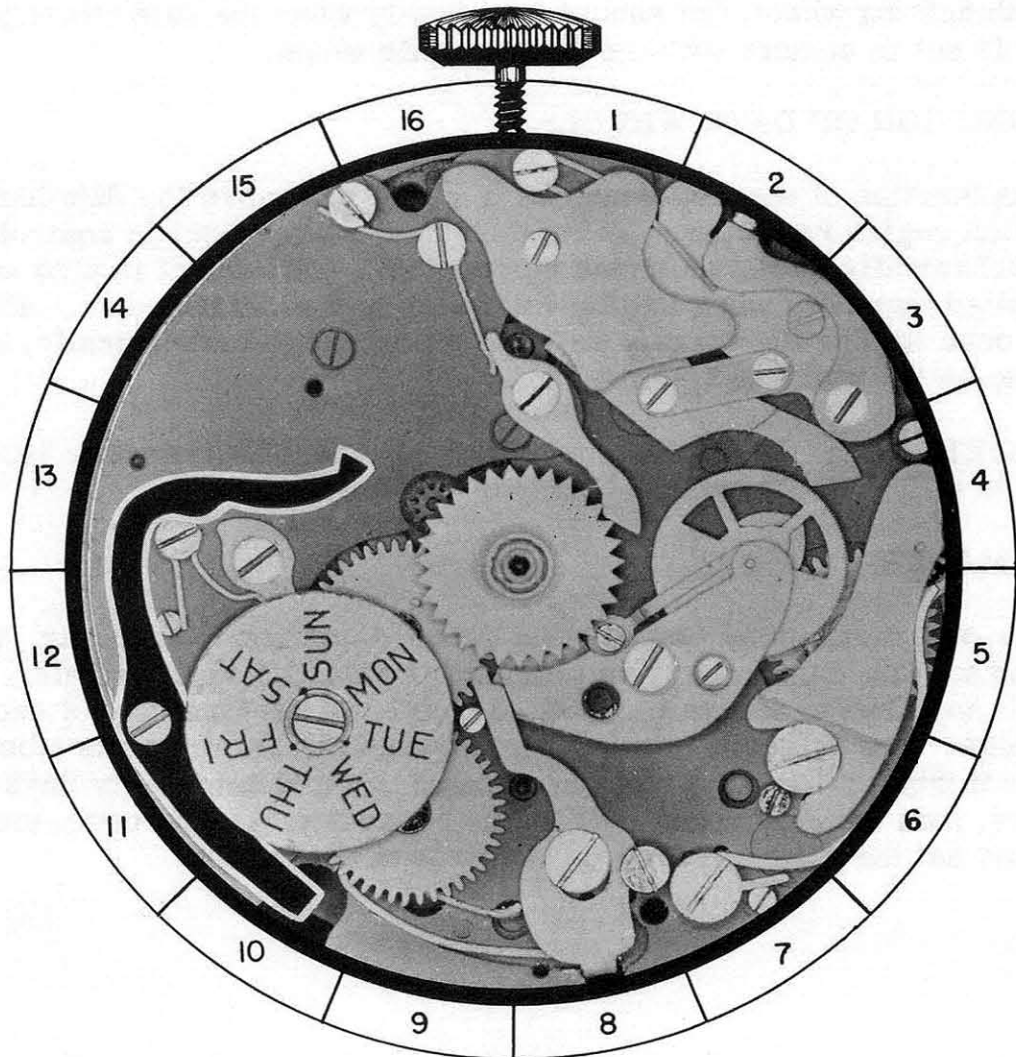

3-A



**A. DISASSEMBLY PROCEDURE OF DATE WHEEL:**

To remove this wheel, use the same procedure as used in removing an ordinary hour wheel, by simply lifting it out of place.

**B. ASSEMBLY PROCEDURE OF DATE WHEEL:**

Place the date wheel over the hour wheel with hairing wheel. Before pressing the date wheel down in position, move the date wheel jumper out from under this wheel. Now press the wheel down to place, so that end "B" of the date wheel jumper meshes with the teeth on the date wheel.

**C. HAZARDS IN ASSEMBLY OF DATE WHEEL:**

When placing the date wheel in position, be sure the date wheel jumper is not under the date wheel, but meshes with the teeth on the date wheel. The date wheel should not bind on the hour wheel with hairing wheel, but should turn freely when the date wheel jumper is not in contact with the teeth on this wheel.

**D. FUNCTION OF DATE WHEEL:**

The function of the date wheel is to carry and move the date hand, which registers the date on the dial. This date wheel is controlled mechanically by the calendar mechanism. This wheel is also controlled manually when setting the watch to the correct date. After it is once set for the correct date, it is controlled mechanically, as long as the watch is running.

**REFERENCE:** Hour wheel with hairing wheel is Assembly 12.  
Date wheel jumper is Assembly 5.

**REMARKS:**

The date mechanism changes the date automatically each day. Of course, this mechanism, as in most all calendar mechanisms, will not always change the date correctly on the first day of each month. The date will only change correctly if the previous month has thirty-one days. If the previous month had only thirty days or less, then the date would not change correctly. In this case, you must set the date manually on the first of the month.

Date Wheel

Assembly 4

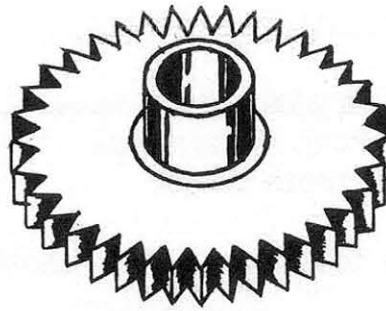

### OILING

The date wheel should not be oiled

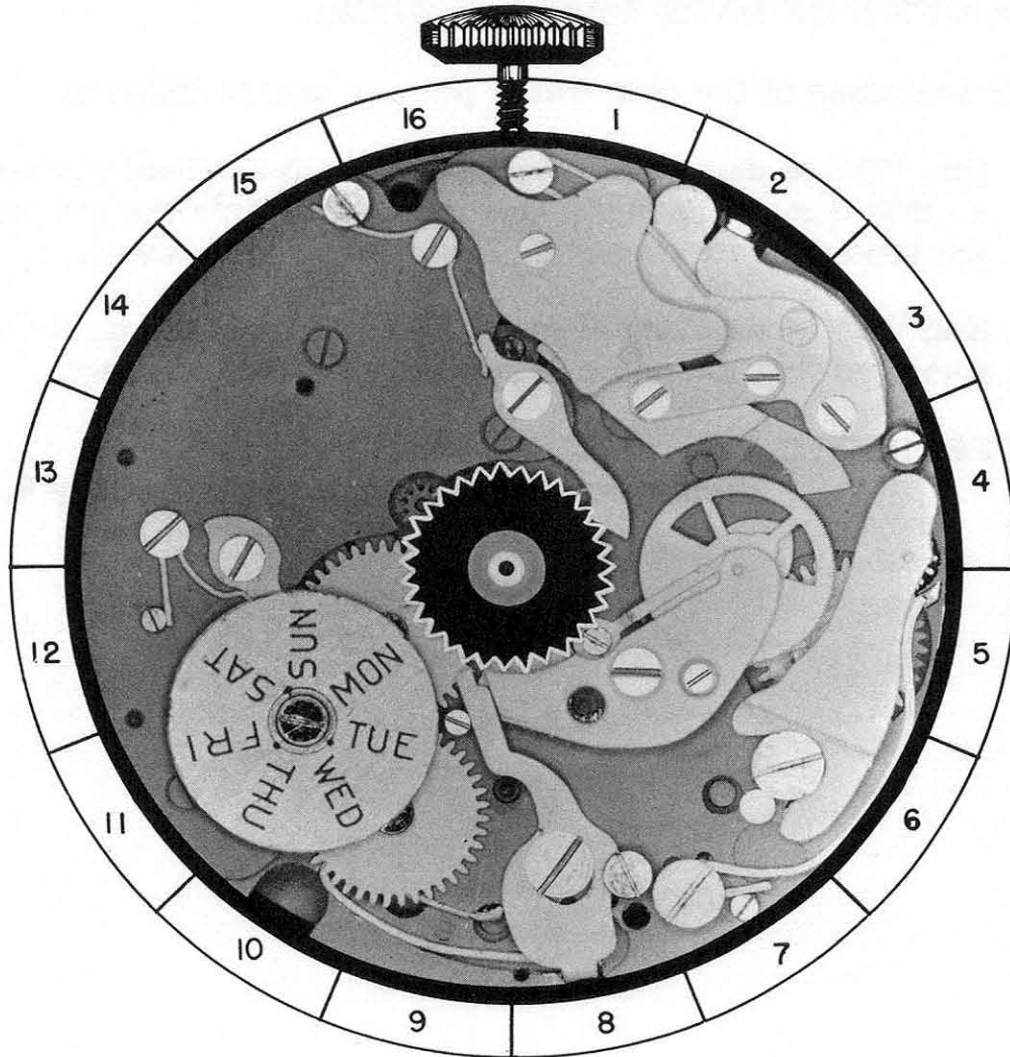

4-A

**A. DISASSEMBLY PROCEDURE OF DATE WHEEL JUMPER:**

This jumper is held in place by a shouldered screw SS-4 and pivots on this screw. When this screw is removed, jumper may be lifted from plate.

(The shape of screw for this part is shown at bottom of page.)

**B. ASSEMBLY PROCEDURE OF DATE WHEEL JUMPER:**

Place the date wheel jumper in proper position on the plate, with end "A" of jumper on the outside of date wheel jumper spring, as shown in the photograph. Then replace shouldered screw SS-4 which holds this jumper in position. The jumper must pivot freely under head of shouldered screw.

**C. FUNCTION OF DATE WHEEL JUMPER:**

The functions of the date wheel jumper are as follows:

1. End "B" of date wheel jumper holds date wheel in place so that it moves exactly one tooth each time the pin on the intermediate date wheel moves the date wheel.
2. End "B" of date wheel jumper keeps a tension on the date wheel so that a bump cannot alter position of wheel.

**REFERENCE:** Date wheel is assembly 4.  
Date wheel jumper spring is Assembly 6.

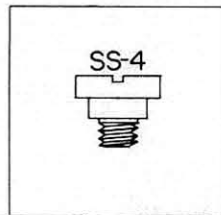

Date Wheel Jumper  
Assembly 5

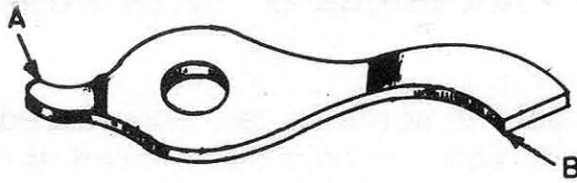

OILING

The shouldered screw, that date wheel jumper pivots on, should be slightly moistened with oil.

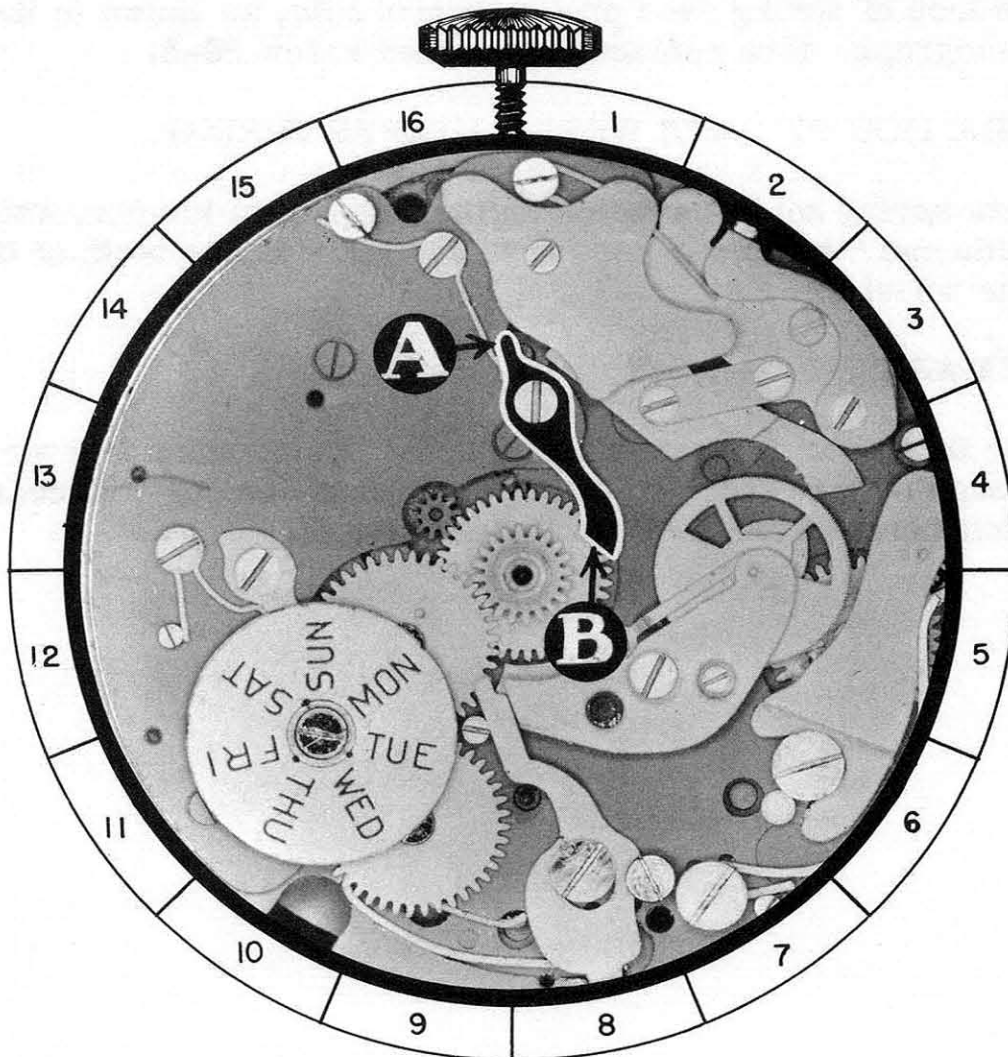

**A. DISASSEMBLY PROCEDURE OF DATE WHEEL JUMPER SPRING:**

This spring is held in place by two shouldered screw, though it is necessary to remove only shouldered screw SS-5. When this screw is removed, end "A" of the spring may be moved out from under the head of the other screw, and the spring lifted from the plate.

(The shape of screw for this part is shown at bottom of page.)

**B. ASSEMBLY PROCEDURE OF DATE WHEEL JUMPER SPRING:**

Place the date wheel jumper spring in position on the plate, with the end "A" under the head of the shouldered screw and the loop of spring over proper screw hole, as shown in the photograph. Now replace shouldered screw SS-5.

**C. FUNCTION OF DATE WHEEL JUMPER SPRING:**

This spring holds a tension on the date wheel jumper, which holds end "A" of the jumper in contact with the teeth of the date wheel.

**REMARKS:**

The tension of the date wheel jumper spring should be strong enough so that end "B" of the date wheel jumper will center itself between two teeth on the date wheel.

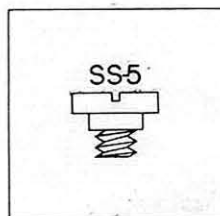

Date Wheel Jumper Spring  
Assembly 6



OILING

End "B" of the date wheel jumper spring should be slightly moistened with oil at point of contact with the date wheel jumper.

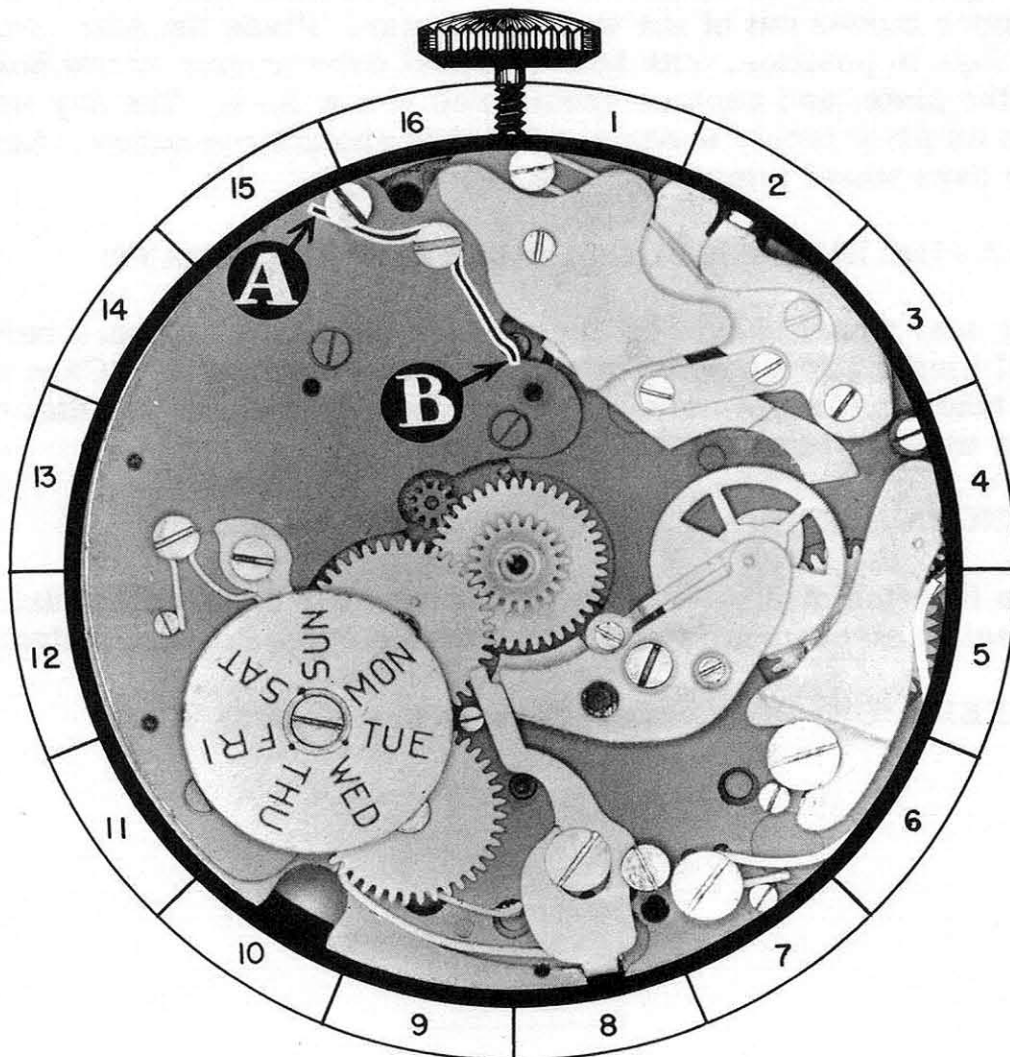

**A. DISASSEMBLY PROCEDURE OF STAR WHEEL OF DAYS:**

This wheel is held in place by shouldered screw SS-6 and pivots on this screw. After the screw is removed, the wheel may be lifted from the plate.

(The shape of screw for this part is shown at bottom of page.)

**B. HAZARDS IN DISASSEMBLY OF STAR WHEEL OF DAYS:**

The dial on the days wheel is very easily marred, so care should be taken that the screwdriver or tweezers do not scratch the dial.

**C. ASSEMBLY PROCEDURE OF STAR WHEEL OF DAYS:**

Place a screwdriver at location "B" on the days wheel jumper, and push in the direction of the arrow, so that end "A" of the jumper moves out of the way of the star. Place the star wheel of days in position, with hole in wheel over proper screw hole in the plate, and replace shouldered screw SS-6. The day wheel should pivot freely under head of this shouldered screw. Now the days wheel jumper may be released.

**D. HAZARDS IN ASSEMBLY OF STAR WHEEL OF DAYS:**

The star wheel should be checked for burrs, as any burr here will hinder proper operation of calendar mechanism. Care should be taken that screwdrivers or tweezers do not mar the dial on this wheel, while it is being replaced.

**E. FUNCTION OF STAR WHEEL OF DAYS:**

The function of this wheel is to register the days on the dial. This wheel is mechanically controlled by the calendar mechanism.

**REFERENCE:** Days wheel jumper is Assembly 8.

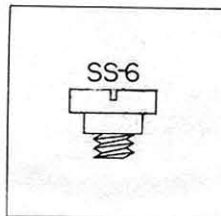

# Star Wheel Of Days Assembly 7

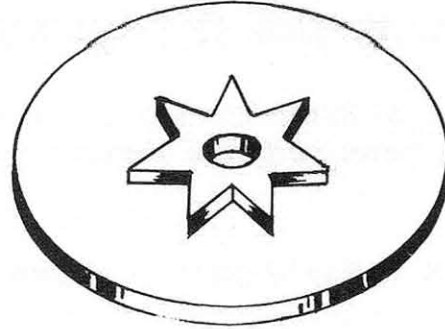

## OILING

The star wheel of days should not be oiled.

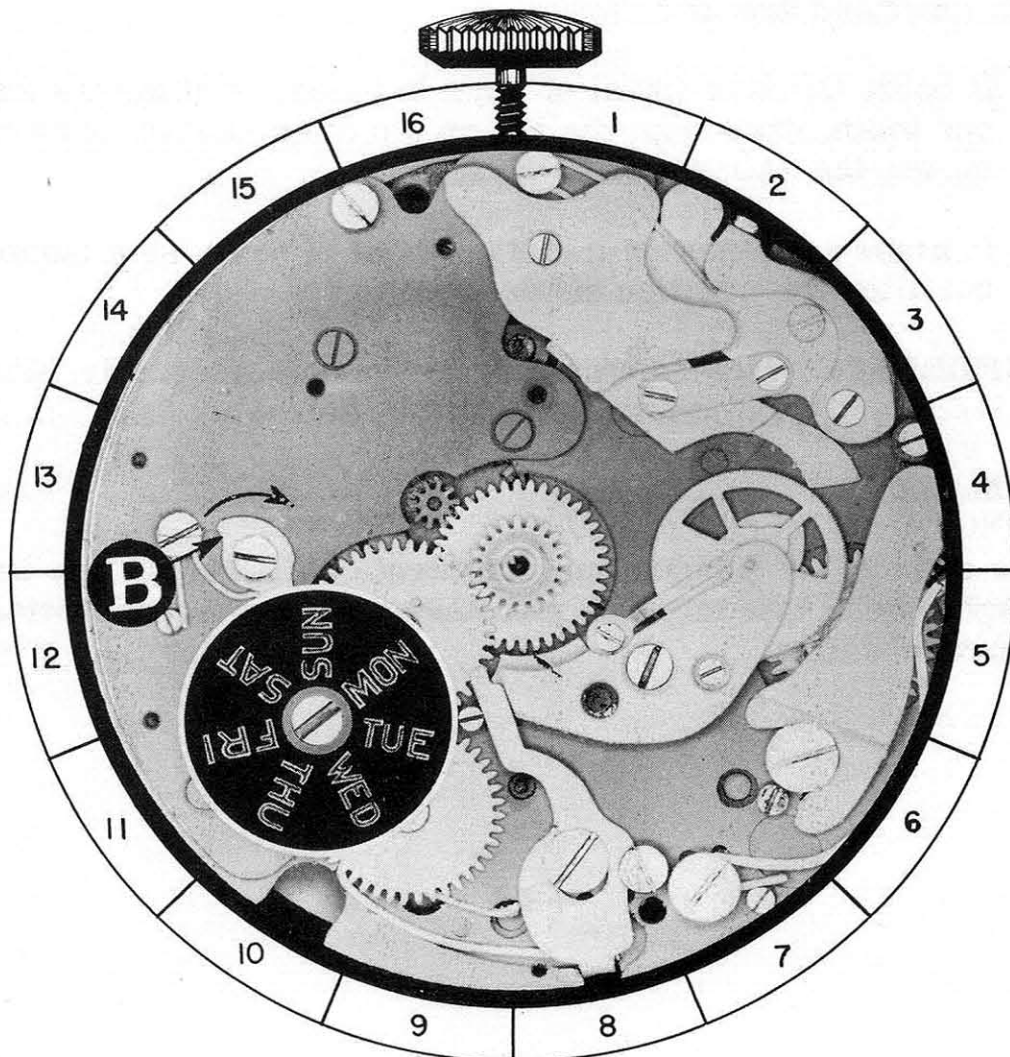

7-A



**A. DISASSEMBLY PROCEDURE OF DAYS WHEEL JUMPER:**

This jumper is held in place by shouldered screw SS-7.  
When this screw is removed, the jumper may be lifted from the plate.

(The shape of screw for this part is shown at bottom of page.)

**B. ASSEMBLY PROCEDURE OF DAYS WHEEL JUMPER:**

Place the jumper in proper position on the plate. Then replace shouldered screw SS-7, which holds jumper in place. This jumper should pivot freely under the head of shouldered screw.

**C. FUNCTION OF DAYS WHEEL JUMPER:**

The functions are as follows:

1. It holds the star wheel of days in place, so it moves exactly one tooth, each time the pin on the intermediate days wheel moves the star wheel of days.
2. It keeps a tension on the star wheel of days, so a bump cannot alter the position of the wheel.

**REFERENCE:** Intermediate days wheel is Assembly 10.  
Star wheel of days is Assembly 7.

**REMARKS:**

The end "A" of jumper must be highly polished, as any burrs or roughness at this location will hinder the proper operation of this mechanism.

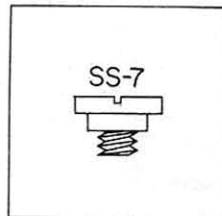

Days Wheel Jumper  
Assembly 8

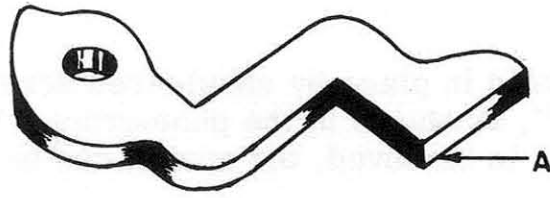

OILING

The shouldered screw, that days wheel jumper pivots on, should be slightly moistened with oil.

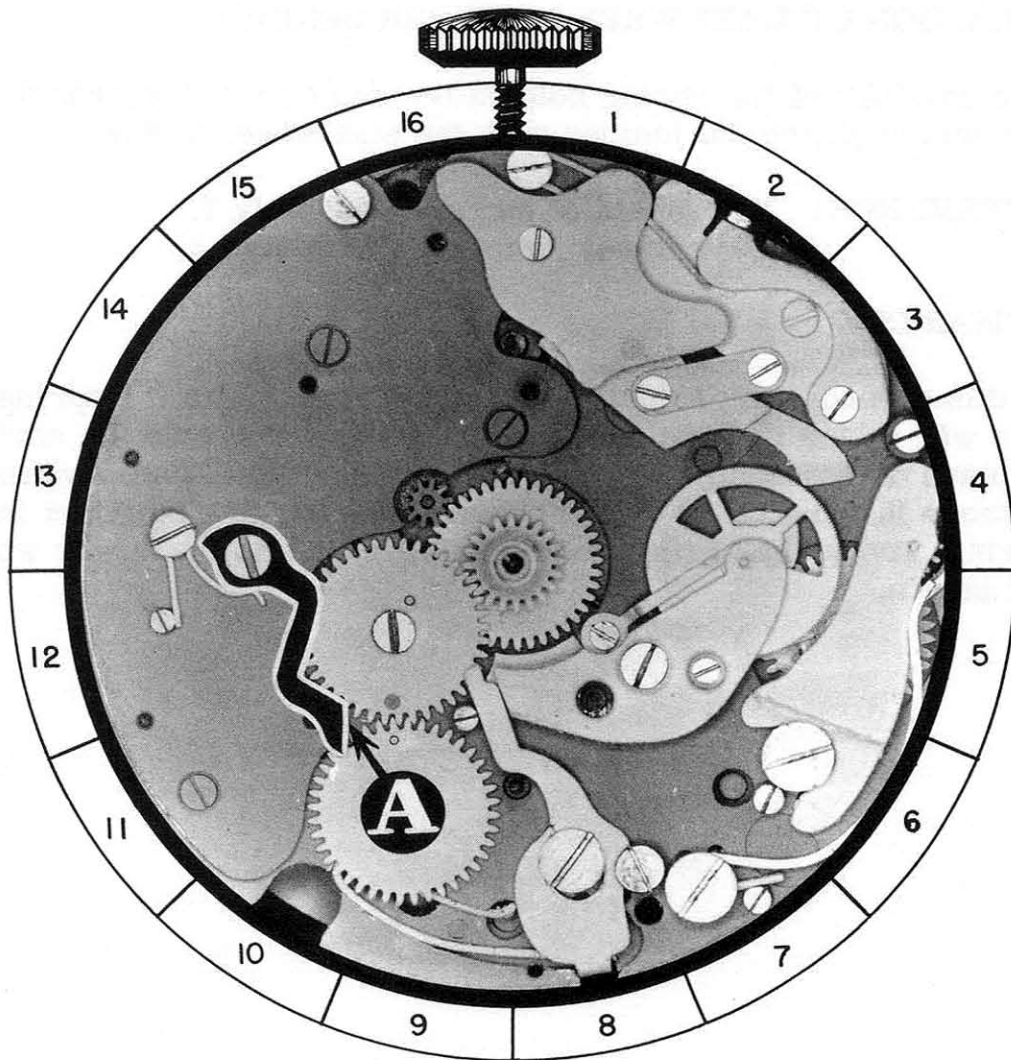

**A. DISASSEMBLY PROCEDURE OF DAYS WHEEL JUMPER SPRING:**

This spring is held in place by shouldered screw SS-8 and screw head "B", as shown in the photograph. When the shouldered screw SS-8 is removed, the spring can be lifted from the plate.

(The shape of screw for this part is shown at bottom of page.)

**B. ASSEMBLY PROCEDURE OF DAYS WHEEL JUMPER SPRING:**

Place the spring in proper position on the plate, as shown in the photograph. Notice position of the spring in relation to the screw head "B". Now replace shouldered screw SS-8.

**C. FUNCTION OF DAYS WHEEL JUMPER SPRING:**

The end "A" of the spring holds a tension on the days wheel jumper, engaging the jumper with the star wheel of days.

**REFERENCE:** Star wheel of days is Assembly 7.  
Days wheel jumper is Assembly 8.

**REMARKS:**

In this chronograph I would like to call attention to the springs. You will notice that the heads of the screws that hold the springs in place do not tighten down on the spring. This is an advantage because in most cases this increases the working length of the spring, giving the spring more flexibility due to its longer working length.

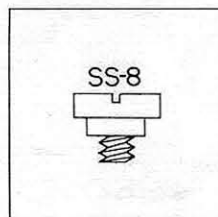

Days Wheel Jumper Spring  
Assembly 9

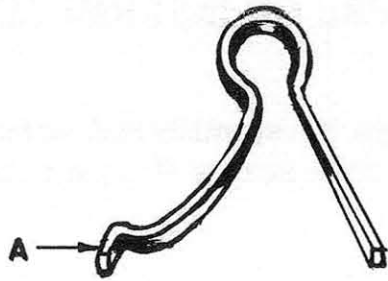

OILING

End "A" of the days wheel jumper spring should be slightly moistened with oil at point of contact with the days wheel jumper.

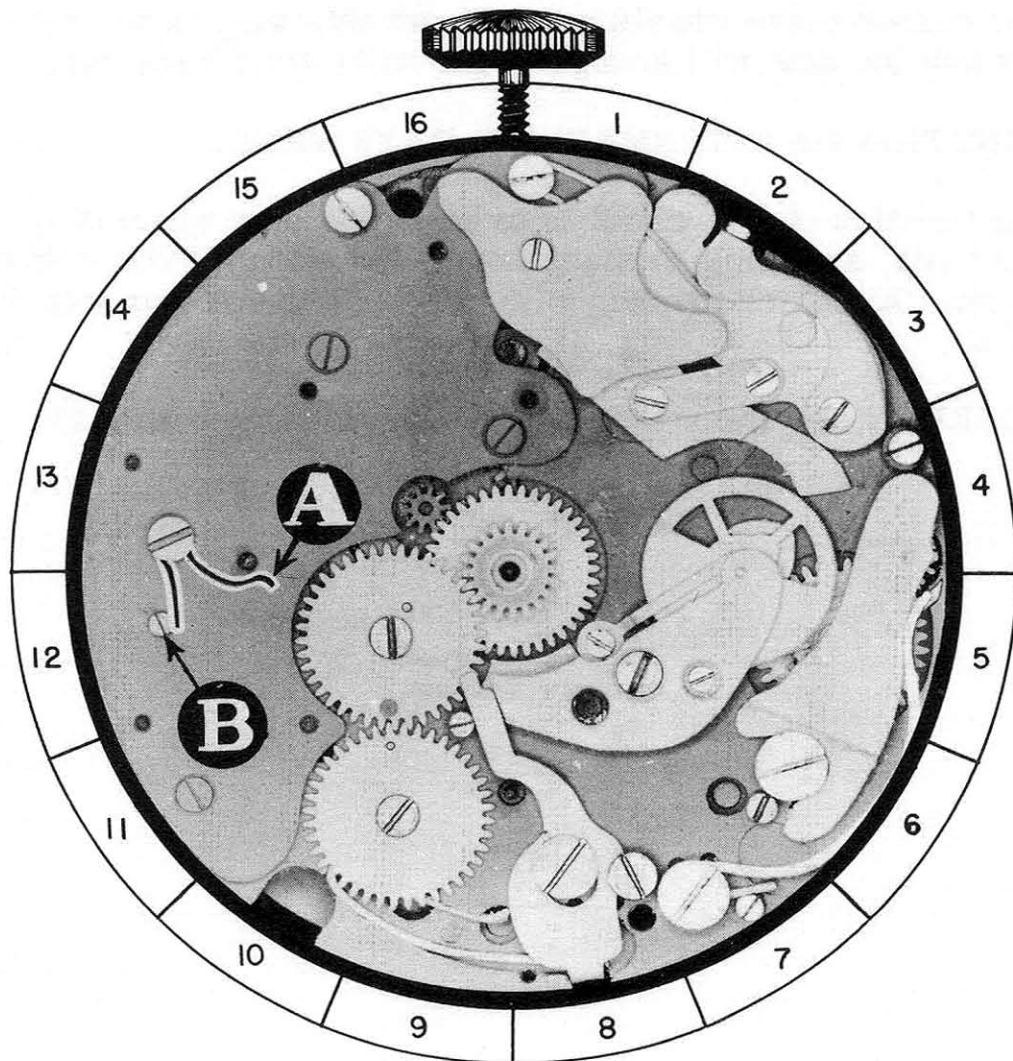

**A. DISASSEMBLY PROCEDURE OF INTERMEDIATE DAYS WHEEL:**

This wheel is held in place by shouldered screw SS-9, and pivots on this screw. When this screw is removed, wheel may be lifted from plate.

(The shape of screw for this part is shown at bottom of page.)

**B. ASSEMBLY PROCEDURE OF INTERMEDIATE DAYS WHEEL:**

Place this wheel in such a position that pin "A" is located directly in line with the countersink "B" on the intermediate date wheel, as shown in the photograph. When this wheel is set correctly, replace shouldered screw SS-9.

The reason these wheels must be set this way, is to assure the day and the date will change at the same time each day.

**C. FUNCTION OF INTERMEDIATE DAYS WHEEL:**

The function of this wheel is to move the star wheel of days one tooth, each time it makes one revolution. This is done by pin "A" which meshes with the teeth on the star wheel of days.

**REFERENCE:** Intermediate date wheel is Assembly 11.

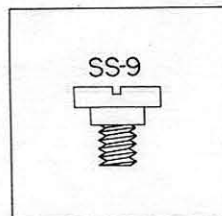

Intermediate Days Wheel  
Assembly 10

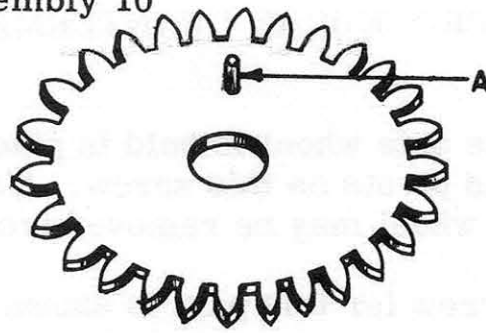

OILING

The intermediate days wheel should not be oiled.

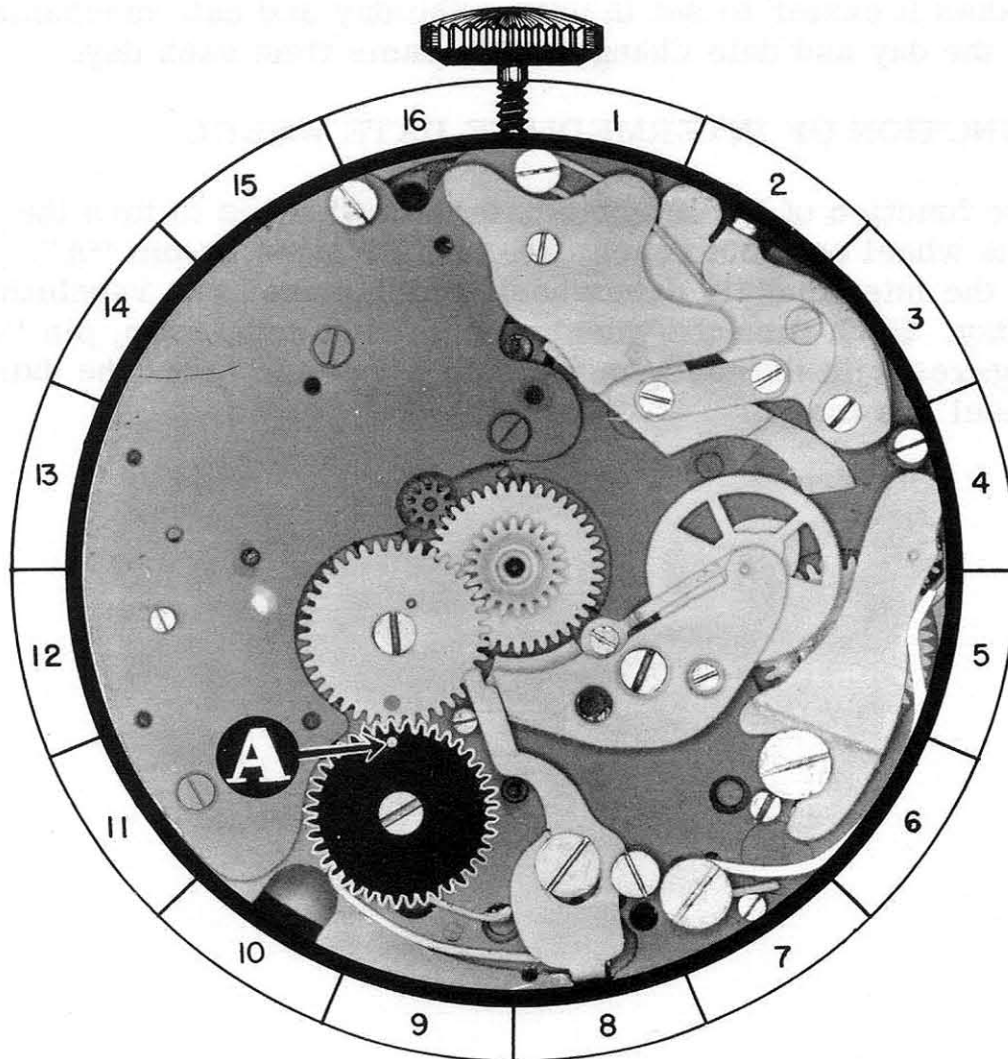

10-A

**A. DISASSEMBLY PROCEDURE OF INTERMEDIATE DATE WHEEL:**

The intermediate date wheel is held in place by shouldered screw SS-10, and pivots on this screw. After screw is removed, the date wheel may be removed from the plate.

(The shape of screw for this part is shown at bottom of page.)

**B. ASSEMBLY PROCEDURE OF INTERMEDIATE DATE WHEEL:**

Place the date wheel on the plate, so countersink "B" is in the exact position shown in the photograph. Now replace shouldered screw SS-10, which holds the wheel in place. The advantage in setting this wheel in its correct position is, it makes it easier to set in unison the day and date mechanism, so the day and date change at the same time each day.

**C. FUNCTION OF INTERMEDIATE DATE WHEEL:**

The function of the intermediate date wheel is to turn the date wheel one tooth each day. This is done by pin "A" on the intermediate date wheel, which makes one revolution a day. Each time the wheel completes a revolution, pin "A" engages with the teeth on the date wheel and turns the date wheel one tooth.

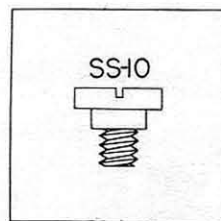

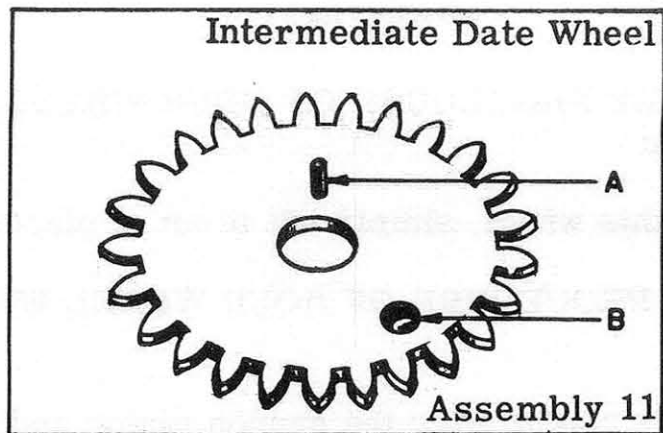

**OILING**

The intermediate date wheel should not be oiled.

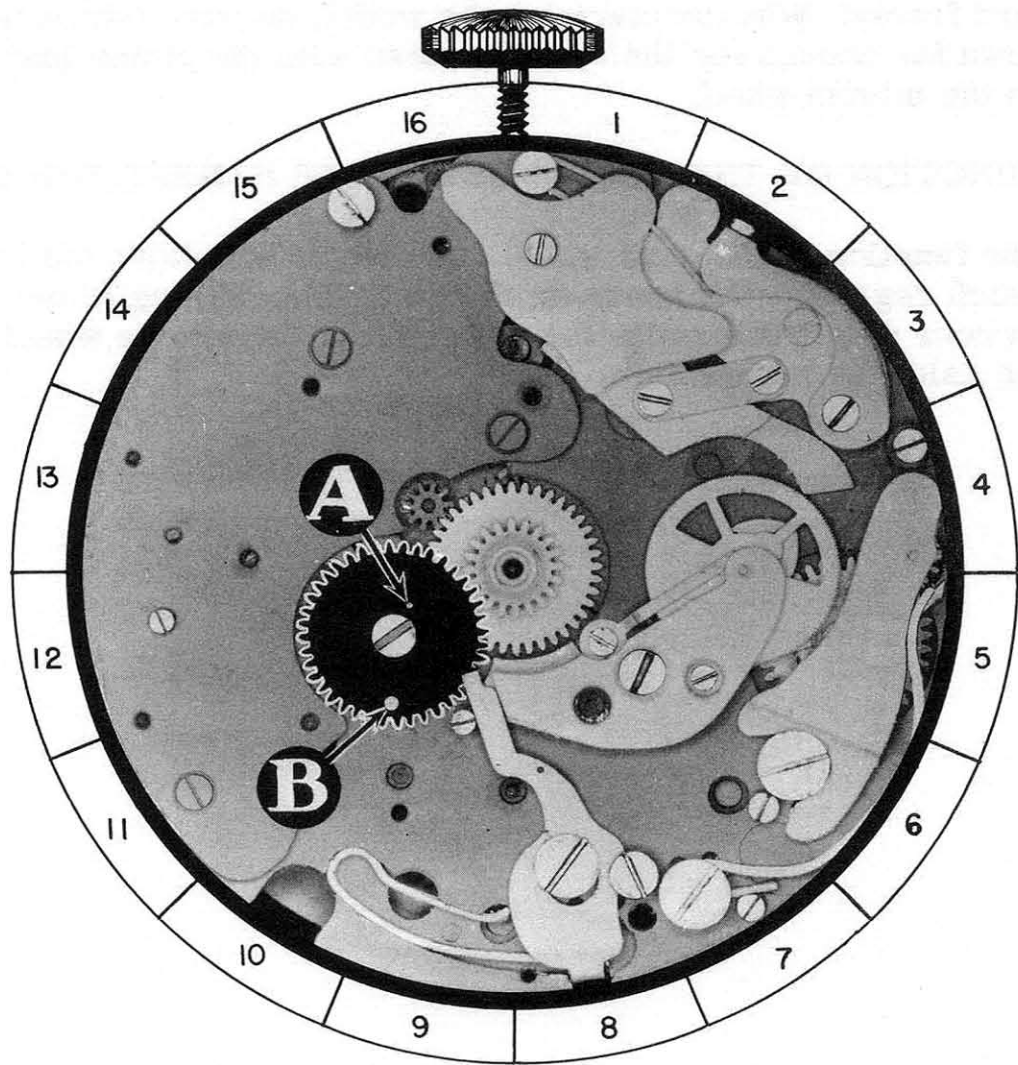

11-A



**A. DISASSEMBLY PROCEDURE OF HOUR WHEEL WITH HAIRING WHEEL:**

To remove this wheel, simply lift it out of place.

**B. ASSEMBLY PROCEDURE OF HOUR WHEEL WITH HAIRING WHEEL:**

This wheel is placed over the cannon pinion and pushed down until the teeth on the hour wheel engage with the teeth on the minute wheel.

**C. HAZARDS IN ASSEMBLY OF HOUR WHEEL WITH HAIRING WHEEL:**

This wheel should not fit tight on the cannon pinion but should turn freely. When replacing hour wheel, be sure that it is down far enough for the teeth to mesh with the pinion leaves on the minute wheel.

**D. FUNCTION OF THE HOUR WHEEL WITH HAIRING WHEEL:**

The function of the hour wheel is to carry and move the hand, which registers the hours on the dial. The hairing wheel "A" on hour wheel transmits the power from the minute wheel to the calendar mechanism.

Hour wheel with hairing wheel  
Assembly 12

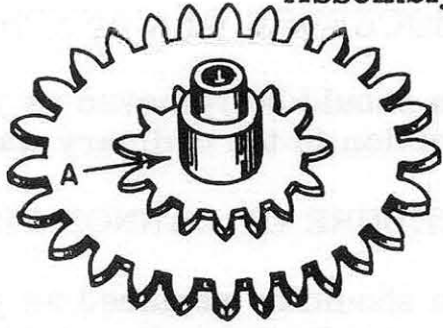

OILING

The hour wheel with hairing wheel should not be oiled.

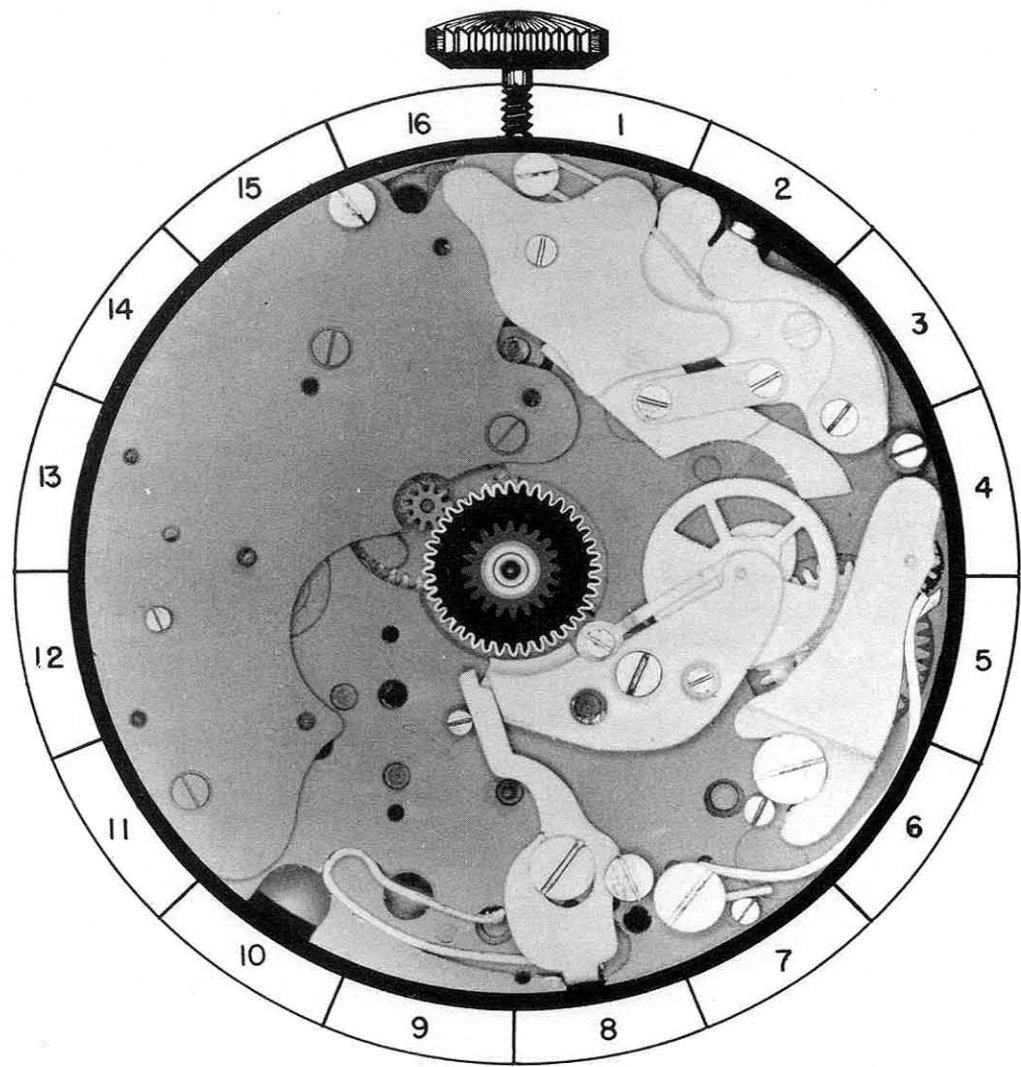

12-A

**A. DISASSEMBLY PROCEDURE OF CANNON PINION:**

This cannon pinion should be removed as you would properly remove a cannon pinion in the ordinary watch.

**B. ASSEMBLY PROCEDURE OF CANNON PINION:**

This cannon pinion should be replaced as you would properly replace a cannon pinion in the ordinary watch.

**C. FUNCTION OF CANNON PINION:**

The function of the cannon pinion is to transmit the power from the train of the watch to the dial train and the calendar mechanism.

### Cannon Pinion Assembly 13

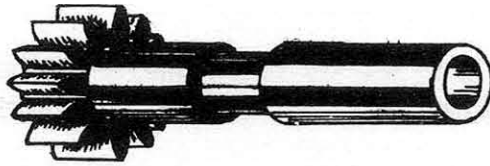

### OILING

Center Wheel Post, that Cannon Pinion fits on, should be slightly moistened with oil.

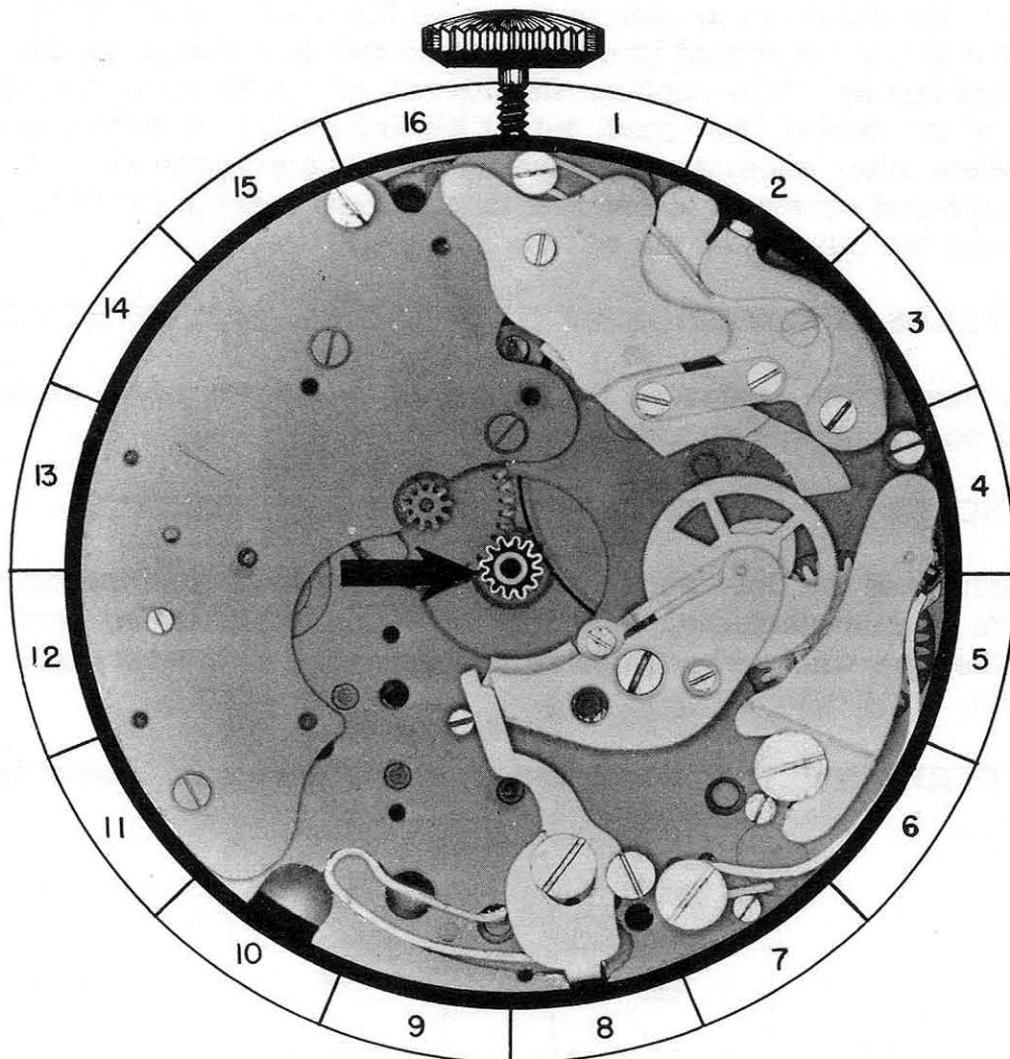

13-A

**A. DISASSEMBLY PROCEDURE OF DATE WHEEL SETTING DETENT:**

This part is held in place by two shouldered screws, SS-11 and SS-12. After shouldered screws are removed, detent can be lifted from plate.

(The shape of these screws is shown at bottom of the page.)

**B. HAZARDS IN DISASSEMBLY OF DATE WHEEL SETTING DETENT:**

Care should be taken when removing this detent, not to bend the long pivot of the fourth wheel.

**C. ASSEMBLY PROCEDURE OF DATE WHEEL SETTING DETENT:**

Place the detent in proper position on the plate. Make sure that end "A" of detent is on outside of the date wheel setting detent spring. Now replace shouldered screw SS-11 in the center of the detent, then push detent toward center of watch, and replace other shouldered screw SS-12. The purpose of this shouldered screw is to prevent detent from moving too far toward the outside of the watch.

**D. HAZARDS IN ASSEMBLY OF DATE WHEEL SETTING DETENT:**

Use care while replacing the detent, so the fourth wheel pivot will not be bent or broken.

**E. FUNCTION OF THE DATE WHEEL SETTING DETENT:**

Function of the date wheel setting detent is to change the date when pushed manually. End "B" of detent contacts the teeth on the date wheel when pushed, and turns the date wheel one tooth.

**REFERENCE:** Date wheel setting detent spring is Assembly 15.

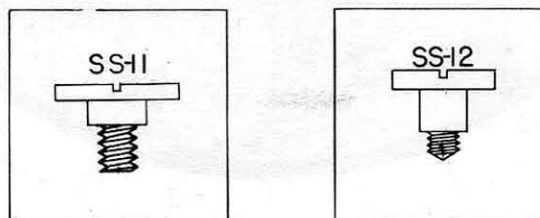

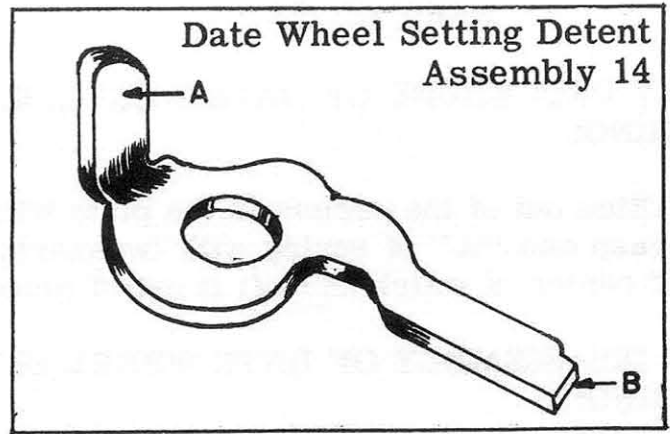

**OILING**

The shouldered screws, that holds the Date Wheel Setting Detent in place, should be slightly moistened with oil.

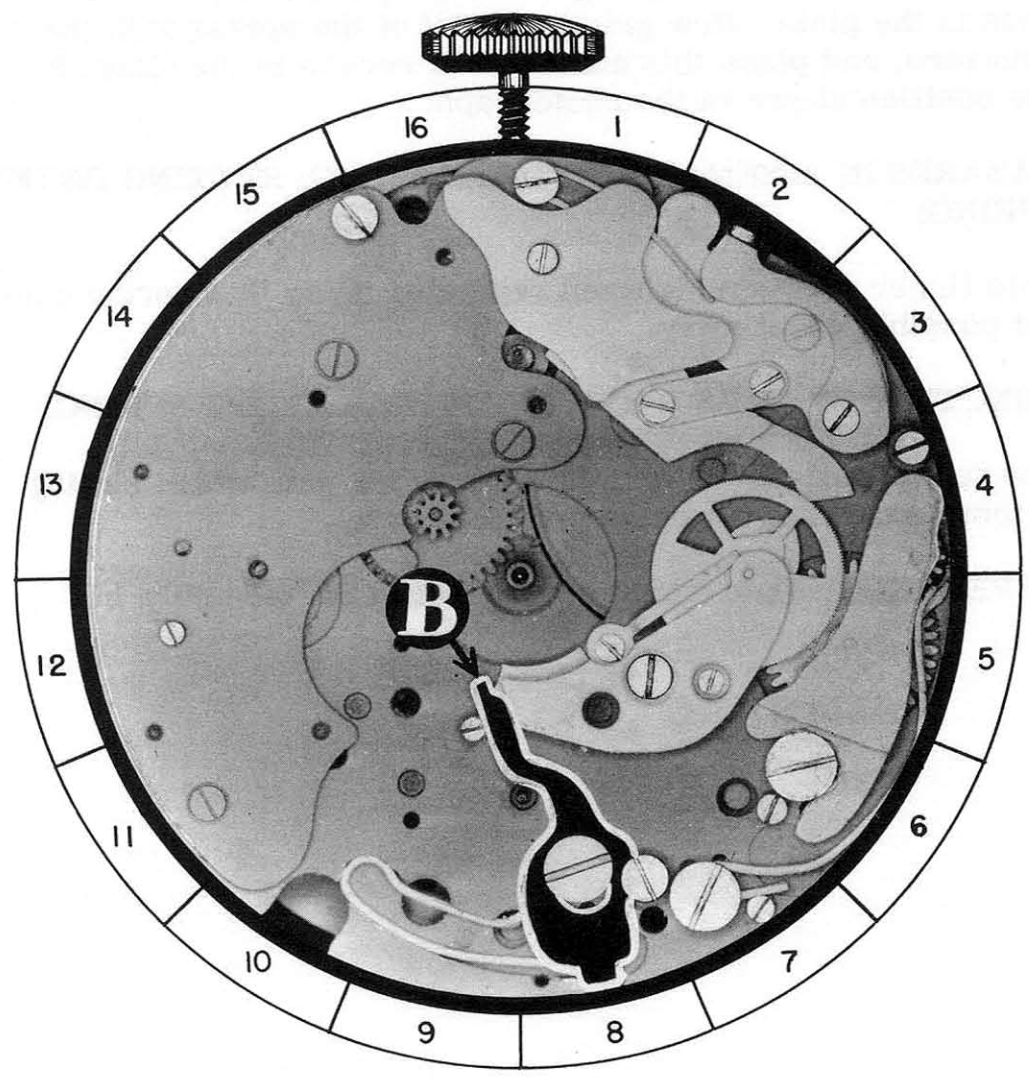

14-A

**A. DISASSEMBLY PROCEDURE OF DATE WHEEL SETTING  
DETENT SPRING:**

This part is lifted out of the recess in the plate with the tweezers. Grasp end "A" of spring with tweezers, pull the spring toward center of watch and lift it out of place.

**B. HAZARDS IN DISASSEMBLY OF DATE WHEEL SETTING  
DETENT SPRING:**

Hold finger over the spring when removing it, so that it does not shoot away.

**C. ASSEMBLY PROCEDURE OF DATE WHEEL SETTING  
DETENT SPRING:**

Place end "B" of the spring in the proper position in the recess in the plate. Now grip end "A" of the spring with the tweezers, and place this end down in recess in the plate, in the position shown in the photograph.

**D. HAZARDS IN ASSEMBLY OF DATE WHEEL SETTING DETENT  
SPRING:**

Hold finger over spring when replacing it, so that spring cannot possibly shoot away.

**E. FUNCTION OF DATE WHEEL SETTING DETENT SPRING:**

The function of this spring is to force the date wheel setting detent away from the center of the watch.

**REFERENCE:** Date wheel setting detent is Assembly 14.

Date Wheel Setting Detent Spring  
Assembly 15

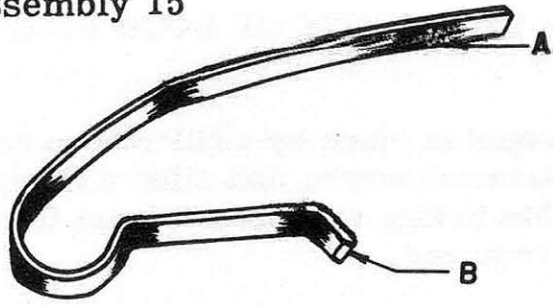

OILING

The Date Wheel Setting Detent Spring should not be oiled.

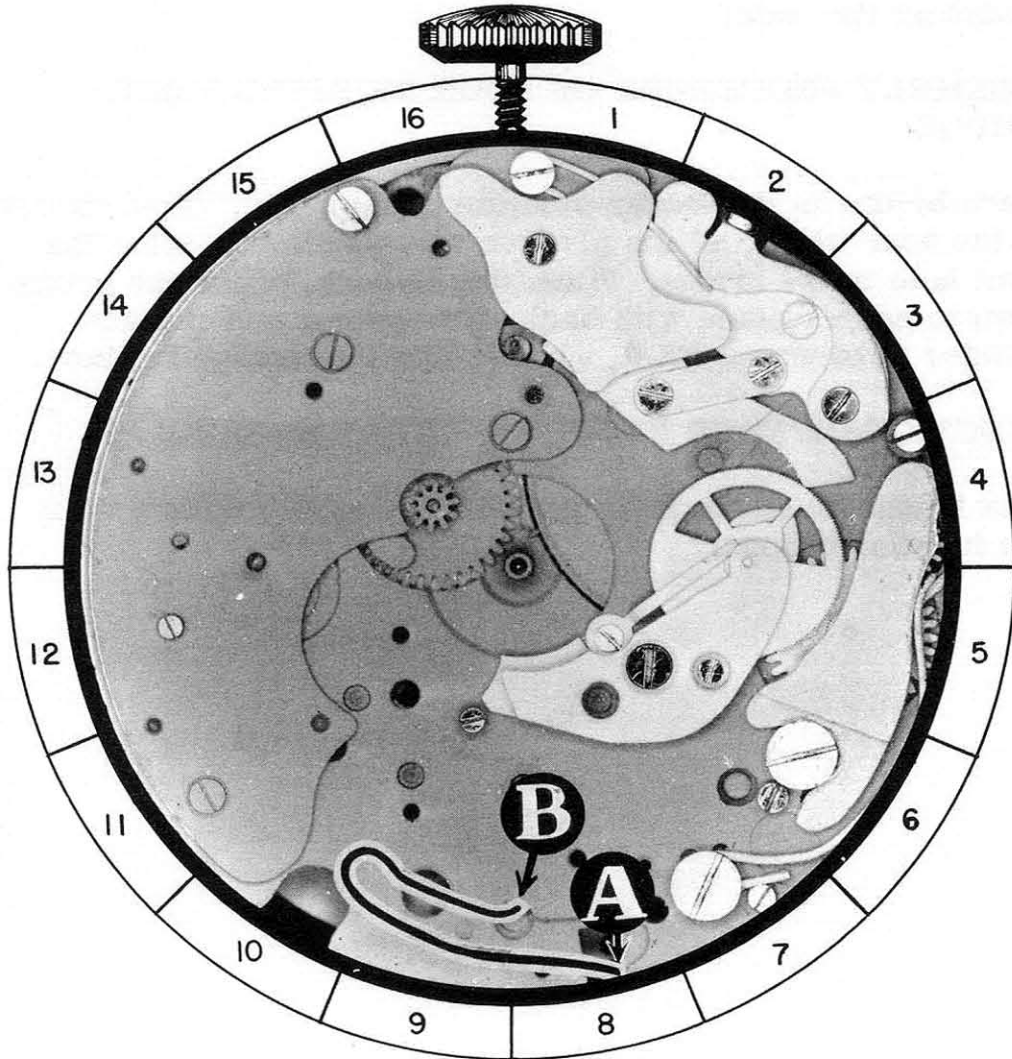

15-A



**A. DISASSEMBLY PROCEDURE OF HOUR REGISTER WHEEL BRIDGE:**

This bridge is held in place by a fillister head screw FS-1 and steady pins. Remove screw, and slide a finely sharpened screwdriver under this bridge to loosen it from the plate. Now the bridge can be removed.

(The shape of screw for this part is shown at bottom of page.)

**B. HAZARDS IN DISASSEMBLY OF HOUR REGISTER WHEEL BRIDGE:**

When using a screwdriver to loosen bridge from plate, care should be taken to keep the bridge level, as any twisting may damage the pivots on the hour register wheel. The screwdriver should be carefully used, to prevent marring of the bridge or the plate.

**C. ASSEMBLY PROCEDURE OF HOUR REGISTER WHEEL BRIDGE:**

Place bridge in its proper position on the plate. Then straighten the hour wheel, so the pivot on this wheel will enter the pivot hole in the bridge. When this is done, press the bridge down to proper place with back of tweezers, and replace fillister head screw FS-1, which holds this bridge in place.

**D. FUNCTION OF HOUR REGISTER WHEEL BRIDGE:**

This bridge holds the hour register wheel in position, so it can function properly.

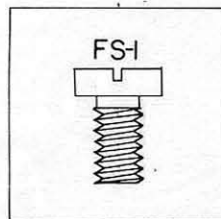

Hour Register Wheel Bridge  
Assembly 16

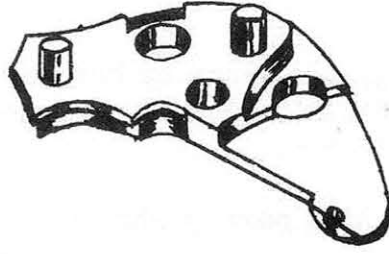

OILING

The pivot in the hour register wheel bridge should be oiled the same as you would normally oil a train pivot in a watch.

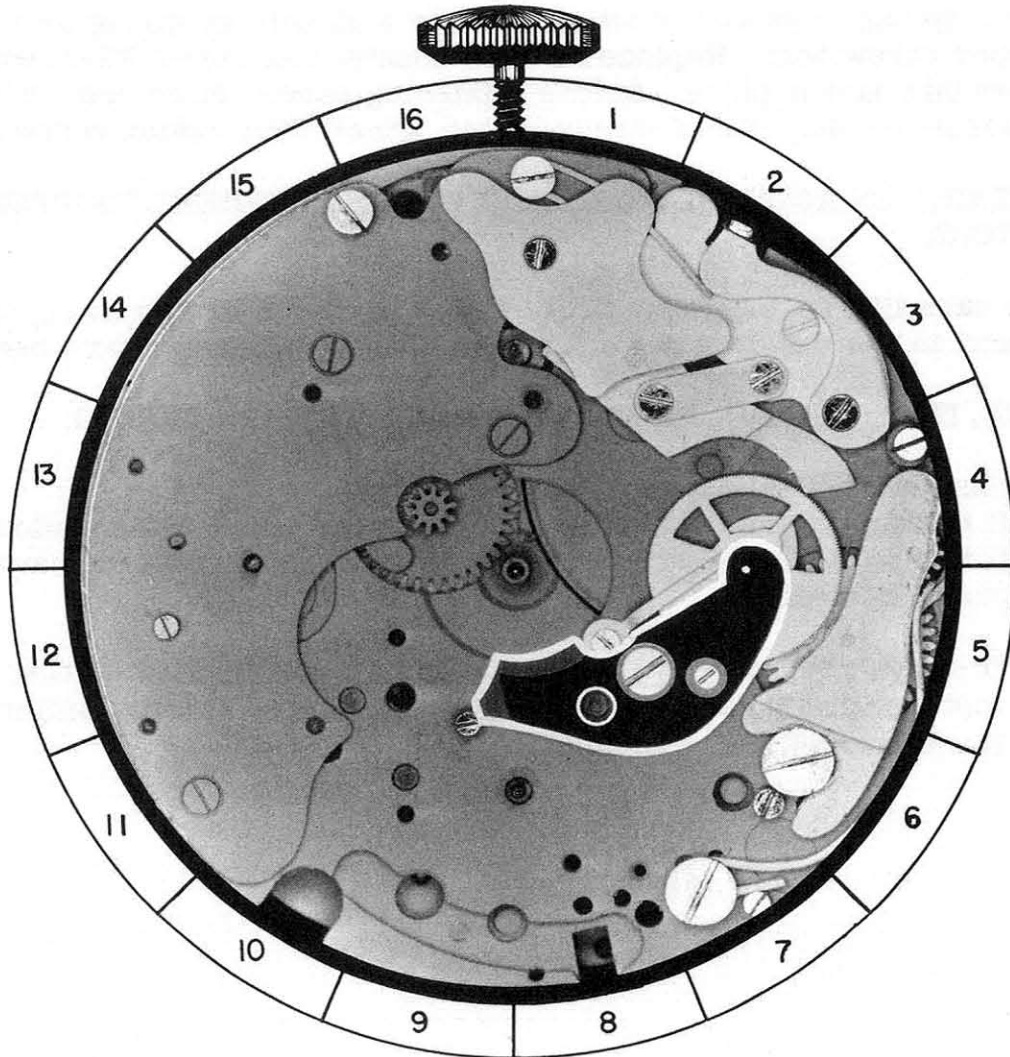

16-A

**A. DISASSEMBLY PROCEDURE OF HOUR REGISTER WHEEL TENSION SPRING:**

This tension spring is held in place by beveled countersink screw BS-1. When this screw is removed, this spring will be free of the plate, and easily removed.

(The shape of screw for this part is shown at bottom of the page.)

**B. HAZARDS IN DISASSEMBLY OF HOUR REGISTER WHEEL TENSION SPRING:**

When removing the tension spring, it should be carefully handled to prevent the spring from shooting away and becoming lost.

**C. ASSEMBLY PROCEDURE OF HOUR REGISTER WHEEL TENSION SPRING:**

Place spring in proper position on plate with hole in spring over proper screw hole. Replace beveled countersink screw BS-1, which holds this part in place. Before tightening screw, place end "A" of spring on shoulder of hour register wheel, then tighten screw.

**D. HAZARDS IN ASSEMBLY OF HOUR REGISTER WHEEL TENSION SPRING:**

Use care that spring is not bent. Check spring after tightening the screw, to see that it is not contacting pivot of hour register wheel.

**E. FUNCTION OF HOUR REGISTER WHEEL TENSION SPRING:**

The functions of this spring are as follows:

1. It holds a tension on the intermediate hour wheel, which holds it in a stationary position when it is disengaged from the chronograph mechanism.
2. It holds a tension on the hour register wheel, eliminating any lost motion between the teeth of this wheel and the pinion on the intermediate hour wheel.

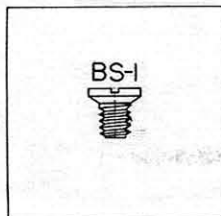

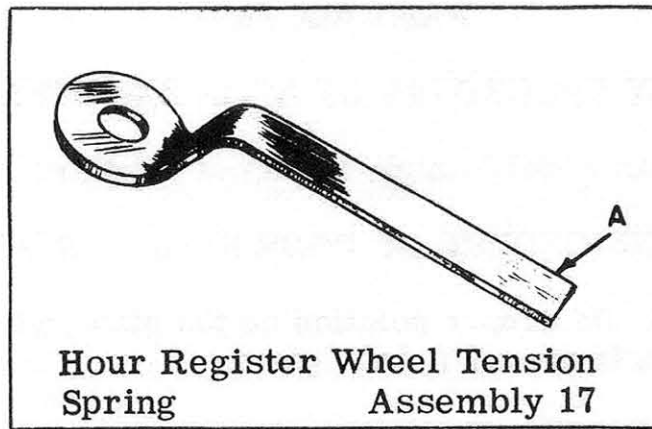

OILING

The hour register wheel tension spring should not be oiled.

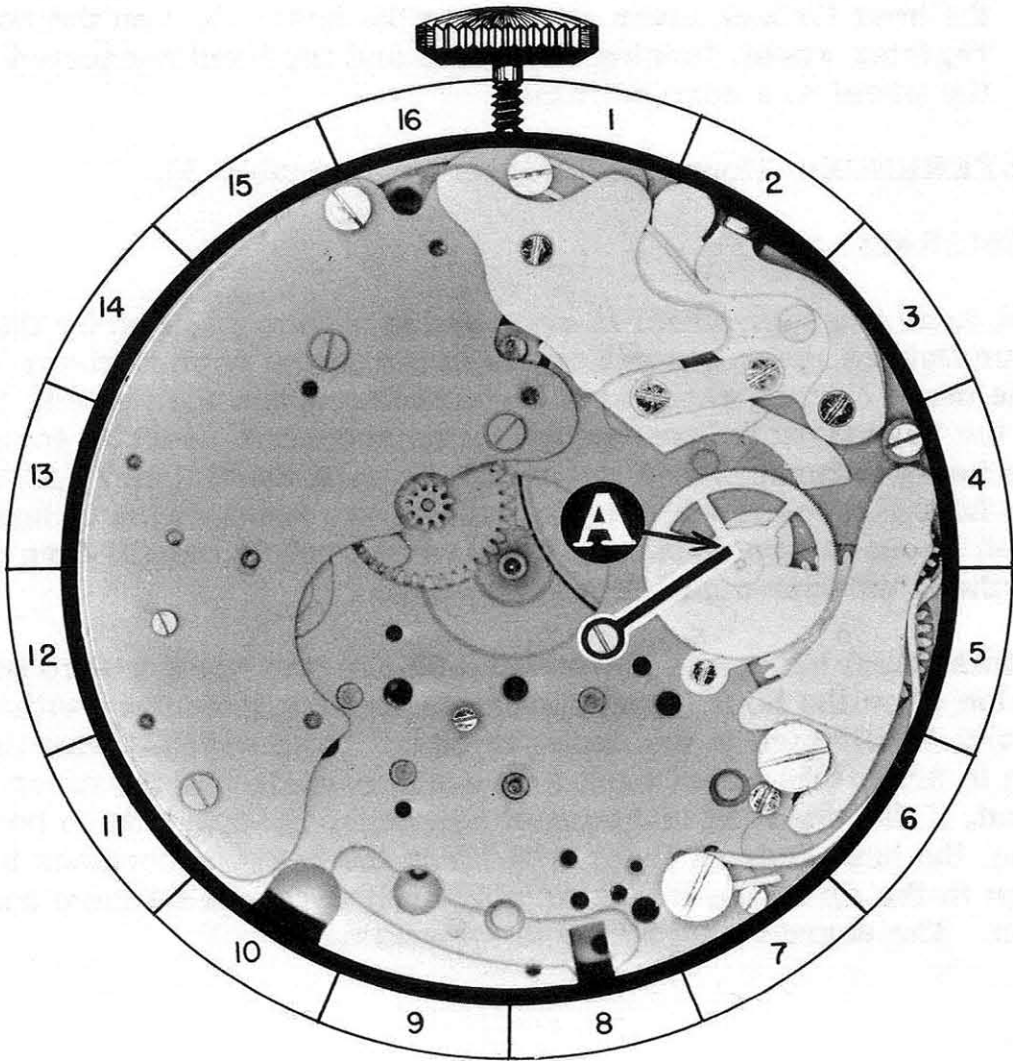

**A. DISASSEMBLY PROCEDURE OF HOUR REGISTER WHEEL:**

To remove this wheel, simply lift it out of place.

**B. ASSEMBLY PROCEDURE OF HOUR REGISTER WHEEL:**

Place wheel in its proper position on the plate, with pivot "A" on wheel down in proper hole in plate.

**C. FUNCTION OF HOUR REGISTER WHEEL:**

The functions of this wheel are:

1. It registers the hours that have elapsed since the beginning of the registration of the sweep second hand.
2. It returns the hour register hand to zero. This is done by the hour flyback lever contacting the heart "D" on the hour register wheel, forcing the wheel and the hand connected to the wheel to a zero position.

**REFERENCE:** Hour flyback lever is Assembly 26.

**REMARKS:**

The hour register wheel is returned to a zero position by the hour flyback lever contacting the heart on the hour register wheel. The heart on this wheel is set eccentric. When the flat end "A" of the hour flyback lever contacts the eccentric heart, it forces the heart to turn. The heart will turn until the flat end "A" of the hour flyback lever sets across the two lobes at top of heart. With the pressure equalized at these two points, it will turn no further, and this would be a zero position.

If this wheel has turned less than 195 degrees from a zero position when the hour flyback lever is brought in contact with the heart, it will turn in the opposite direction to which it was turning to bring this wheel back to a zero position. On the other hand, if the wheel is turned past 195 degrees from a zero position, the hour flyback lever will force the heart to continue to turn in the direction it was turning until it reaches a zero position. The degree used above is approximate.

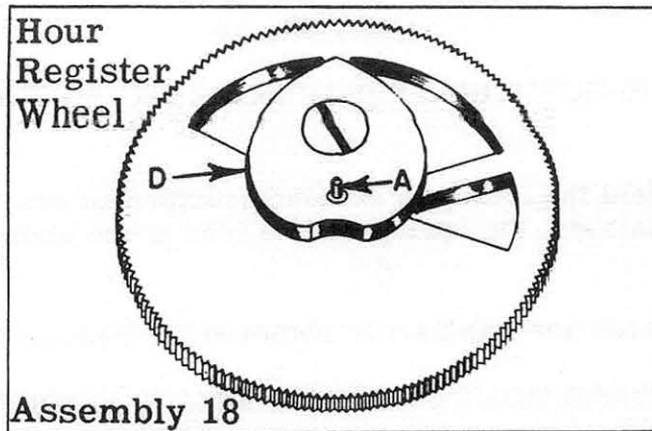

### OILING

The bottom pivot of the hour register wheel should be oiled before replacing it in position.

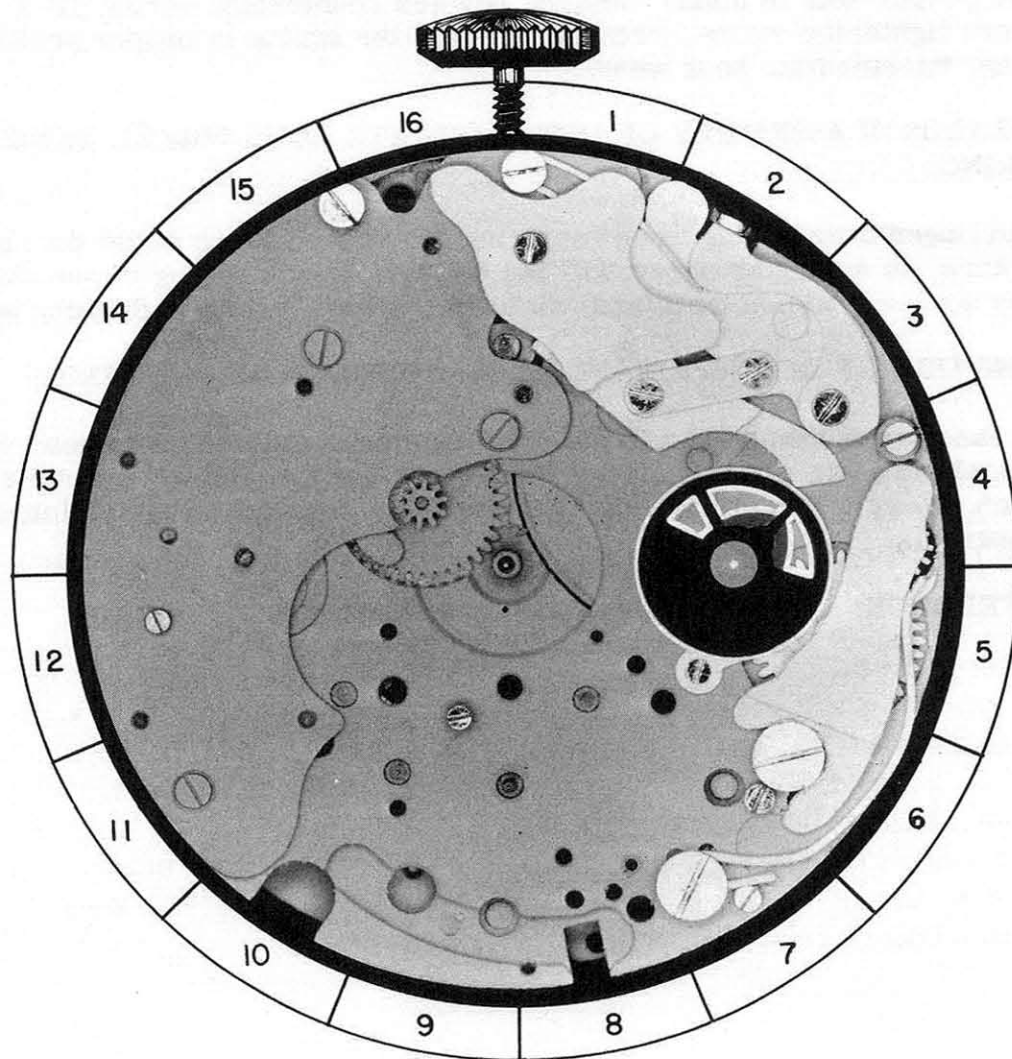

18-A

**A. DISASSEMBLY PROCEDURE OF INTERMEDIATE HOUR WHEEL TENSION SPRING:**

This spring is held in place by a beveled countersink screw BS-2. When this screw is removed, the spring will be free of the plate, and easily removed.

(The shape of screw for this part is shown at the bottom of the page.)

**B. HAZARDS IN DISASSEMBLY OF INTERMEDIATE HOUR WHEEL TENSION SPRING:**

Handle spring carefully when removing it, or spring may shoot away and become lost.

**C. ASSEMBLY PROCEDURE OF INTERMEDIATE HOUR WHEEL TENSION SPRING:**

Place the spring in proper position on the plate, with hole in the spring over proper hole in plate. Replace beveled countersink screw BS-2, but before tightening screw, place end "A" of the spring in proper position on the intermediate hour wheel.

**D. HAZARDS IN ASSEMBLY OF INTERMEDIATE HOUR WHEEL TENSION SPRING:**

Hold finger over spring when replacing the screw, which holds the spring in place, so spring or screw will not be lost. Check spring to see that it does not touch pinion on intermediate hour wheel, before tightening screw.

**E. FUNCTION OF INTERMEDIATE HOUR WHEEL TENSION SPRING:**

The function of this spring is to hold a tension on intermediate hour wheel, thus, eliminating any lost motion between this wheel and the transmission pinion or any lost motion in the teeth between the transmission pinion and the barrel.

**REFERENCE:** Transmission pinion is Assembly 22.  
Intermediate hour wheel is Assembly 21 A.

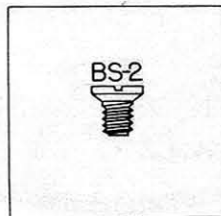

Intermediate Hour Wheel  
Tension Spring Assembly 19

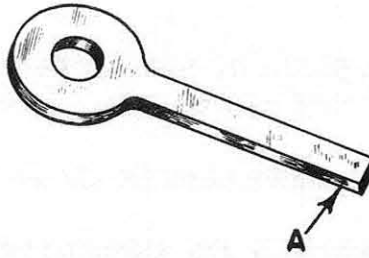

OILING

The intermediate hour wheel tension spring should not be oiled.

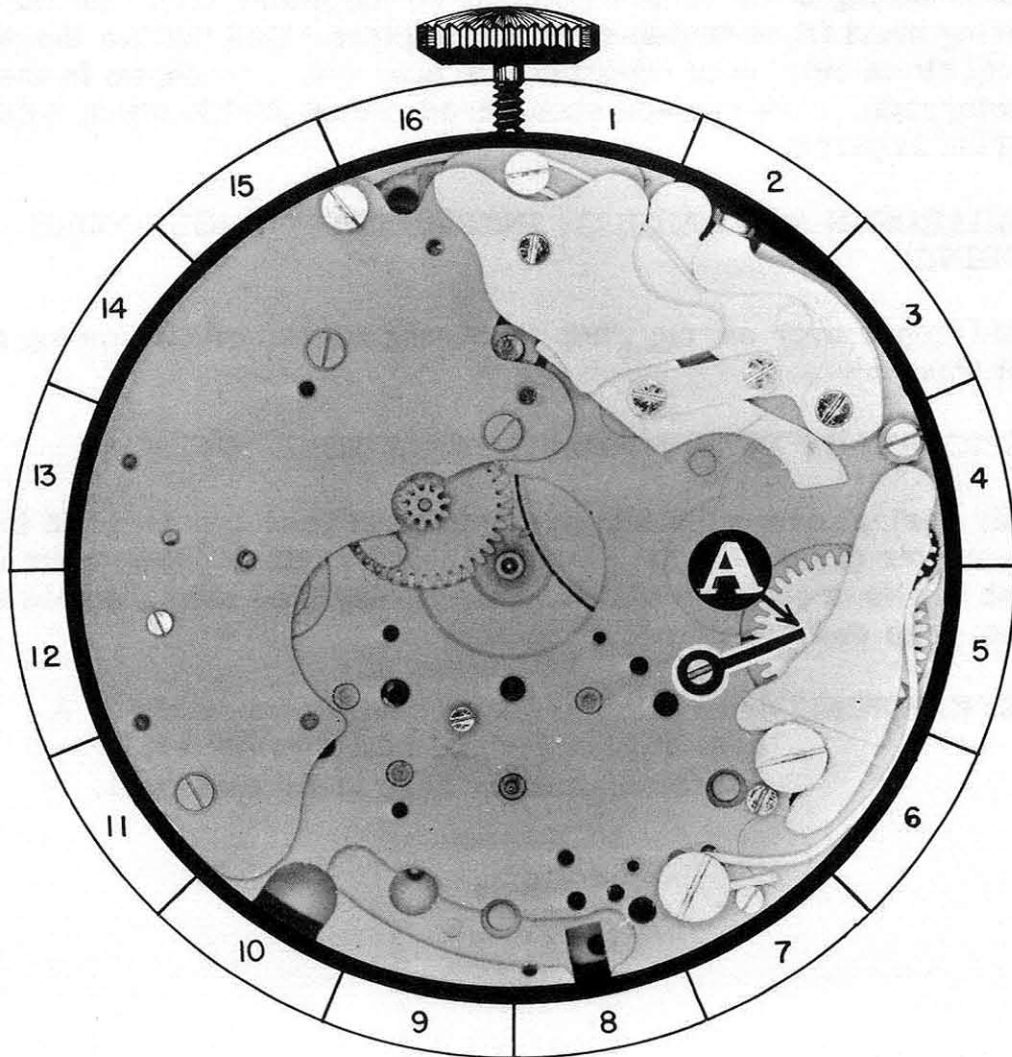

19-A



**A. DISASSEMBLY PROCEDURE OF INTERMEDIATE HOUR YOKE SPRING:**

This spring is held in place by shouldered screw SS-13. When the screw is removed, spring can be lifted from the plate.

(The shape of screw for this part is shown at bottom of page.)

**B. HAZARDS IN DISASSEMBLY OF INTERMEDIATE HOUR YOKE SPRING:**

Hold finger over spring when removing screw, so the spring cannot shoot away.

**C. ASSEMBLY PROCEDURE OF INTERMEDIATE HOUR YOKE SPRING:**

Place spring in its proper position on the plate. End "B" of the spring must fit on inside of screw in plate. End "A" of the spring must fit on outside of intermediate hour yoke, as shown in the photograph. Now replace shouldered screw SS-13, which holds this spring in place.

**D. HAZARDS IN ASSEMBLY OF INTERMEDIATE HOUR YOKE SPRING:**

Hold finger over spring when replacing screw, so the spring cannot shoot away.

**E. FUNCTION OF INTERMEDIATE HOUR YOKE SPRING:**

This spring forces the intermediate hour yoke and wheel in toward the center of the watch. This engages the intermediate hour wheel with the hour register wheel. This spring also helps to hold the hour yoke down to its proper place.

**REFERENCE:** Intermediate hour wheel is Assembly 21 A.  
Hour register wheel is Assembly 18.  
Intermediate hour yoke is Assembly 21.

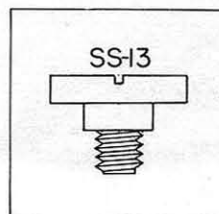

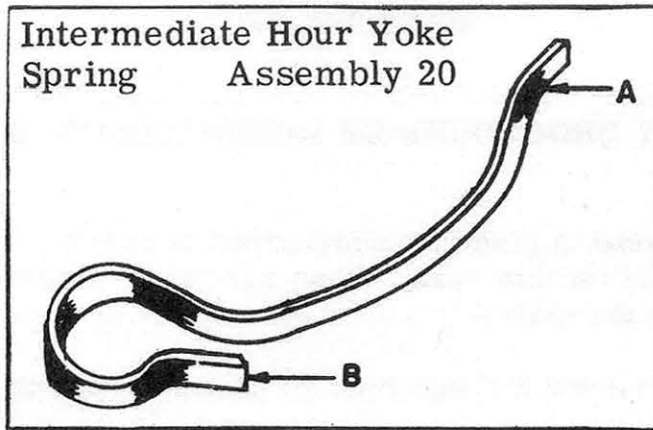

### OILING

End 'A' of intermediate hour yoke spring should be slightly moistened with oil, where it contacts intermediate hour yoke.

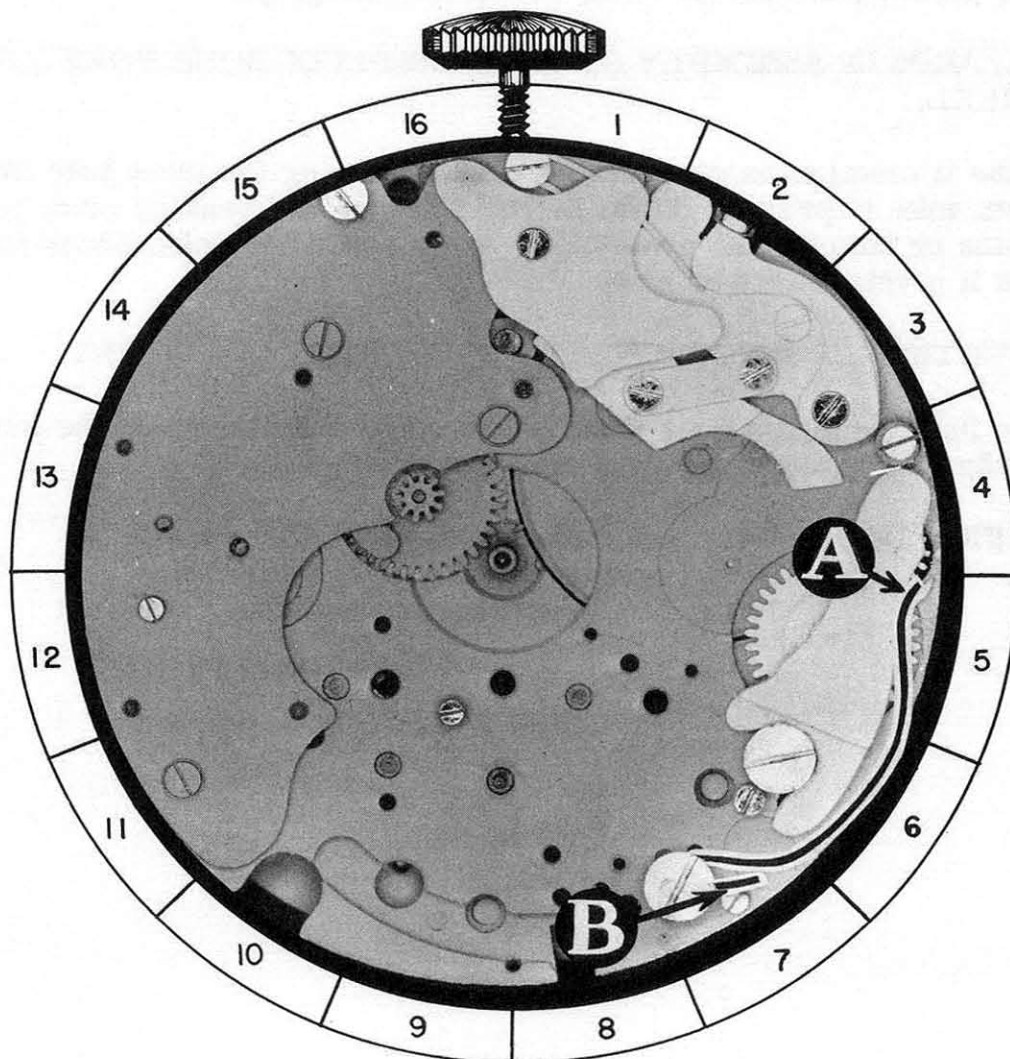

20-A

**A. DISASSEMBLY PROCEDURE OF INTERMEDIATE HOUR YOKE AND WHEEL:**

This yoke is held in place by shouldered screw SS-14 and a stud . The yoke pivots on this stud. When screw is removed, the yoke can be lifted from the plate.

(The shape of screw for this part is shown at bottom of the page.)

**B. ASSEMBLY PROCEDURE OF INTERMEDIATE HOUR YOKE AND WHEEL:**

Place the yoke in proper position on plate with stud on yoke over proper hole in plate. Before pressing yoke down, be sure pivot on transmission pinion is entering pivot hole in yoke. Now press the yoke down to proper place, and replace shouldered screw SS-14. The position of this screw is shown in photograph.

**C. HAZARDS IN ASSEMBLY OF INTERMEDIATE HOUR YOKE AND WHEEL:**

If the transmission pinion pivot is not entering the pivot hole in yoke when yoke is pressed down, there is danger of breaking pivot on pinion or burring the pivot hole. After replacing yoke, check to see that it pivots freely on stud.

**D. FUNCTION OF INTERMEDIATE HOUR YOKE AND WHEEL:**

The function of the hour yoke is to engage and disengage the intermediate hour wheel with the hour register wheel.

**REFERENCE:** Intermediate hour wheel is Assembly 21 A.  
Hour register wheel is Assembly 18.  
Transmission pinion is Assembly 22.

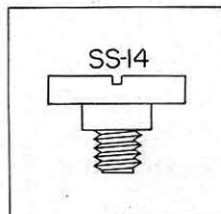

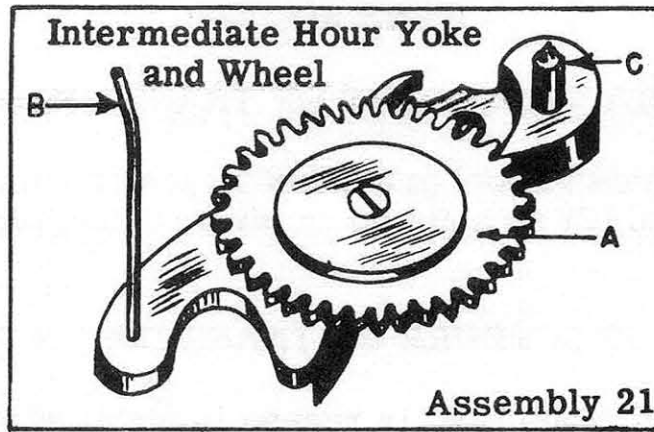

The intermediate hour yoke and wheel should be slightly moistened with oil at the following points:

1. Stud "C" on which the hour yoke pivots.
2. Pin "B" at point of contact with end "A" on the "Lever arm hour yoke," which is on the train side of the movement.

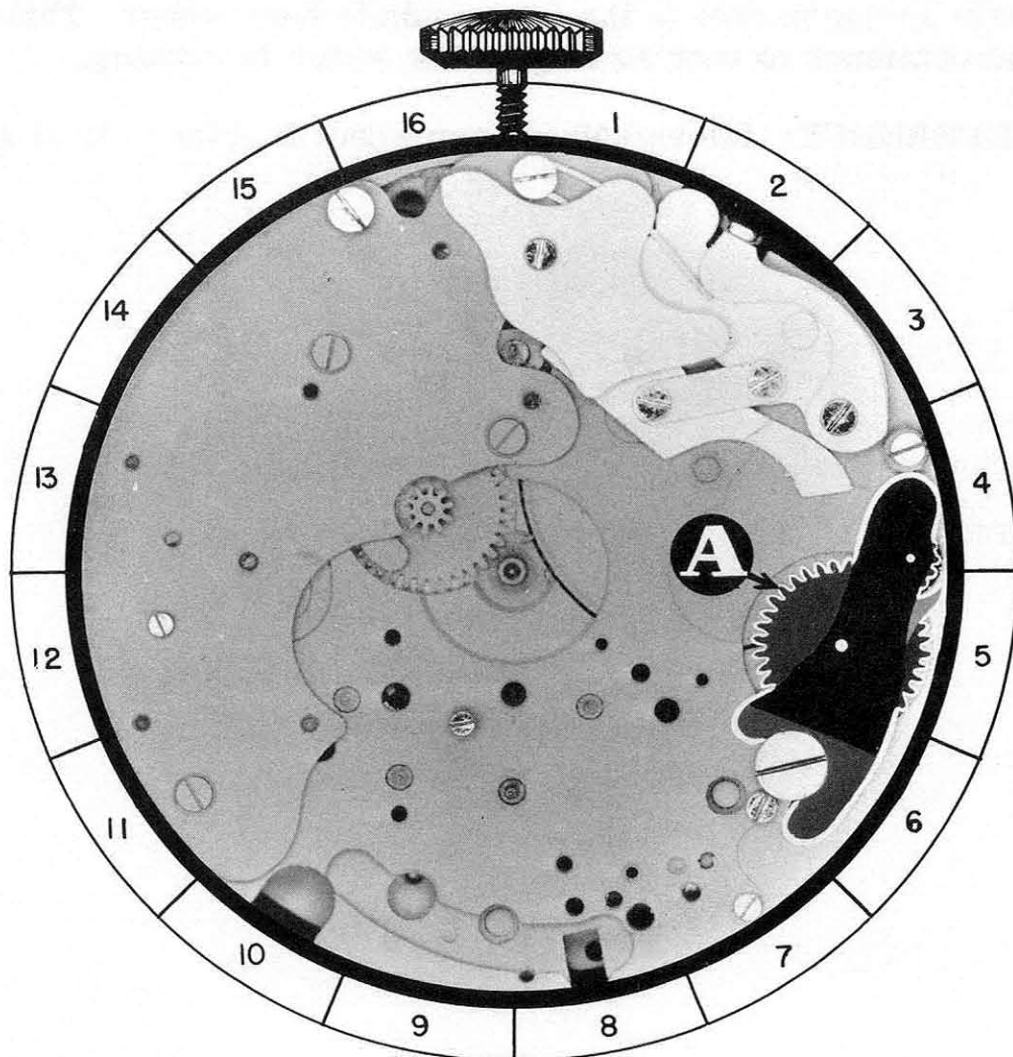

21-A

**A. DISASSEMBLY PROCEDURE OF TRANSMISSION PINION:**

To remove this pinion, grip pivot on pinion with a pair of tweezers and lift straight up on pivot, lifting pinion out of place.

**B. ASSEMBLY PROCEDURE OF TRANSMISSION PINION:**

Place pinion in position, in recess in plate, with pivot on pinion in pivot hole. Either end of this pinion may be placed down as both ends of pinion are identical. The next part to be replaced holds this pinion in place.

**C. FUNCTION OF TRANSMISSION PINION:**

The function of this pinion is to transmit the power from the main spring barrel to the intermediate hour wheel. This pinion continues to turn as long as the watch is running.

**REFERENCE:** Intermediate hour wheel is Assembly 21 A.

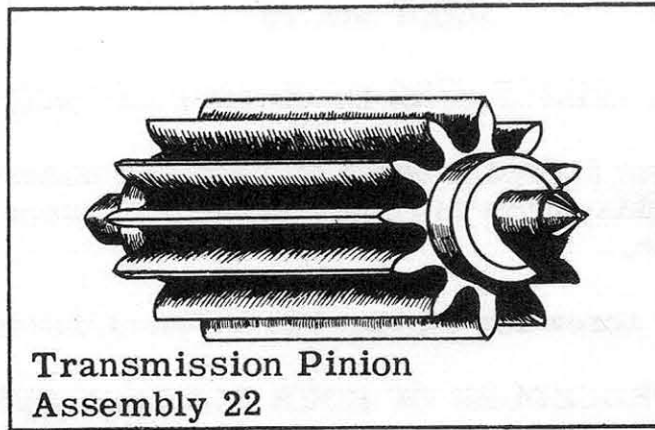

### OILING

The bottom pivot on the transmission pinion should be oiled before placing the pinion in position in the movement.

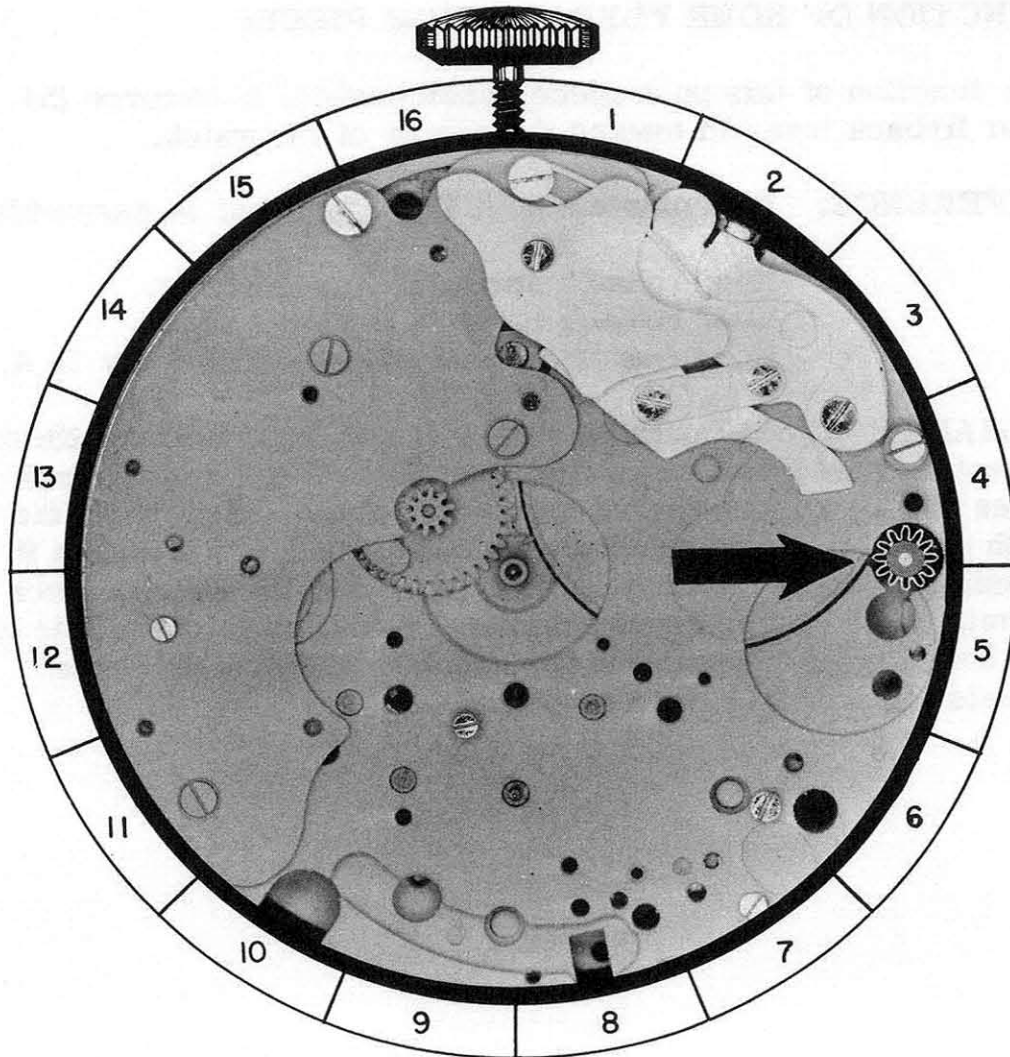

**A. DISASSEMBLY PROCEDURE OF HOUR FLYBACK PUSH PIECE:**

This push piece is held in place by beveled countersink screw BS-3. When this screw is removed, the push piece may be lifted out of place.

(The shape of screw for this part is shown at bottom of page.)

**B. ASSEMBLY PROCEDURE OF HOUR FLYBACK PUSH PIECE:**

Place the push piece in position on the intermediate hour flyback detent, with location "A" against the outside of the eccentric stud "B". End "A" of the hour flyback spring should be on the inside of the push piece, as shown in the photograph. Replace beveled countersink screw BS-3, which holds push piece in position.

**C. FUNCTION OF HOUR FLYBACK PUSH PIECE:**

The function of this push piece, when pushed, is to force the hour flyback lever in toward the center of the watch.

**REFERENCE:** Intermediate hour flyback detent is Assembly 28.  
Hour flyback spring is Assembly 24.  
Hour flyback lever is Assembly 26.  
Hour register wheel heart is Assembly 18 A.

**REMARKS:** This adjustable push piece, in conjunction with the eccentric stud ES-5, determines the amount the hour flyback lever will be moved toward the center of the watch, when the push piece for setting back to zero is pushed. This makes it possible to bring the hour flyback lever and the flyback lever in unison, so that an equal pressure is applied to the hearts of the hour register wheel and the seconds wheel, when these wheels are held at a zero position.

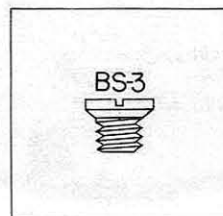

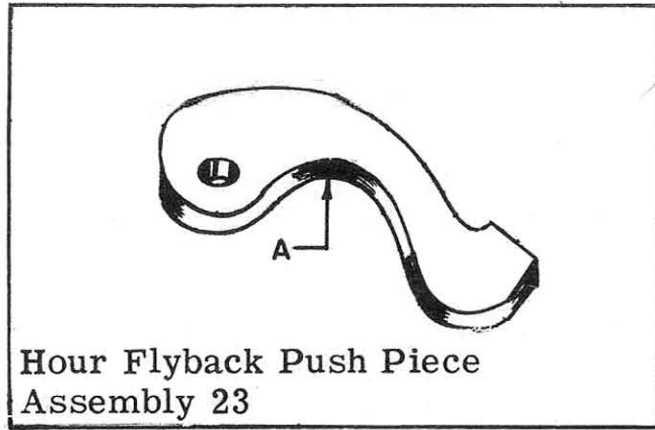

Hour Flyback Push Piece  
Assembly 23

### OILING

The hour flyback push piece should be slightly moistened with oil at point of contact with end "A" of the hour flyback spring.

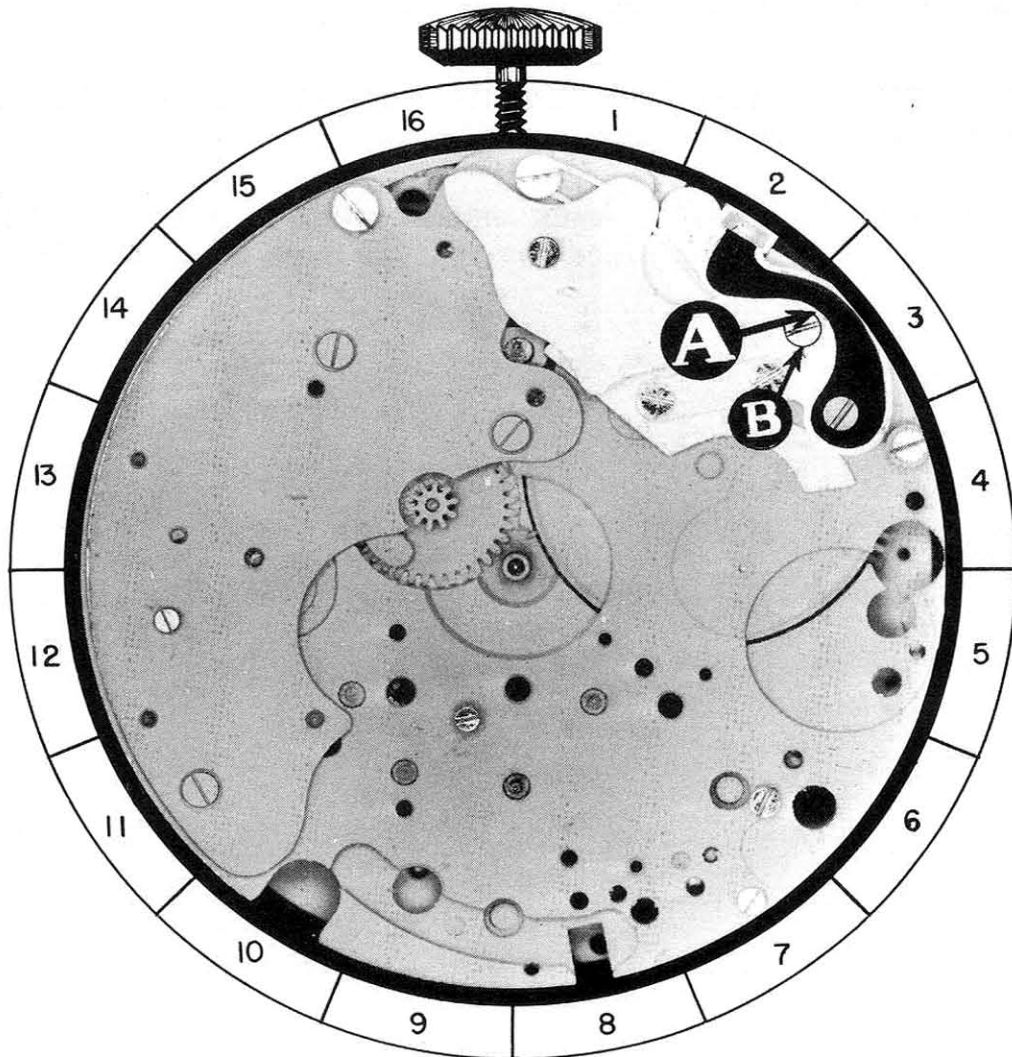



**A. DISASSEMBLY PROCEDURE OF HOUR FLYBACK SPRING:**

This spring is held in place by shouldered screw SS-15. After this screw is removed, slide end "B" from underneath hour flyback lever bridge, and lift it from plate.

(The shape of screw for this part is shown at bottom of page.)

**B. ASSEMBLY PROCEDURE OF HOUR FLYBACK SPRING:**

Place spring in proper position on plate with end "B" underneath hour flyback lever bridge, and end "A" on the inner side of end "B" of push piece for setting back to zero. Now slide loop in spring over proper screw hole in plate and replace shouldered screw SS-15.

**C. FUNCTION OF HOUR FLYBACK SPRING:**

This spring forces all the moving parts of hour flyback mechanism away from the center of the watch.

**REFERENCE:** Hour flyback lever bridge is Assembly 25.  
Push piece for setting back to zero is Assembly 49.

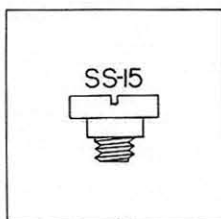

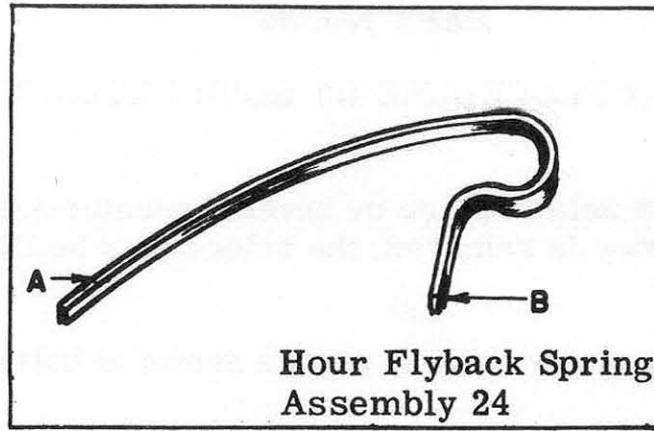

### OILING

End "A" of the hour flyback spring should not be oiled until the next part is replaced.

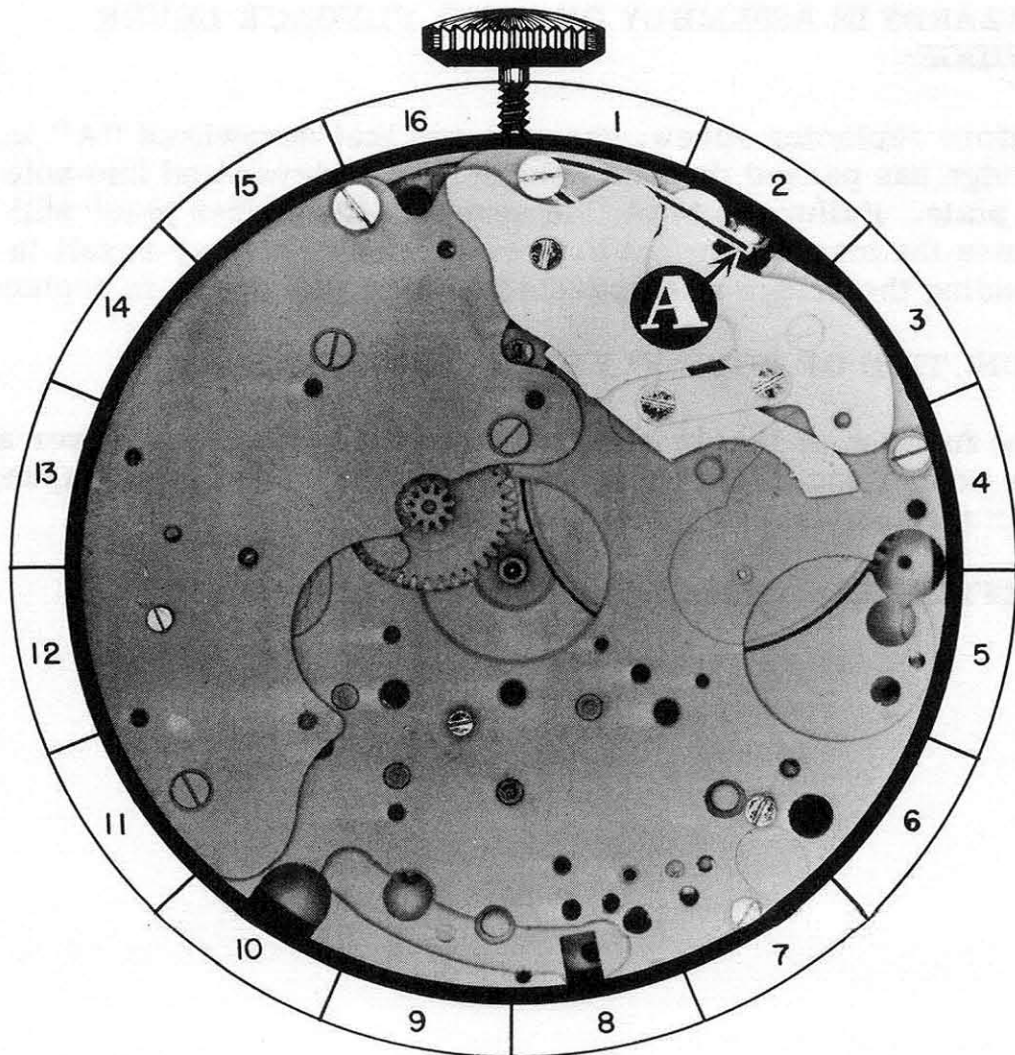

24-A

**A. DISASSEMBLY PROCEDURE OF HOUR FLYBACK LEVER BRIDGE:**

This bridge is held in place by beveled countersink screw BS-4. When this screw is removed, the bridge may be lifted from the plate.

(The shape of screw for this part is shown at bottom of page.)

**B. ASSEMBLY PROCEDURE OF HOUR FLYBACK LEVER BRIDGE:**

Before replacing the bridge, check to see that hole "B" in hour flyback lever is directly over the hole in the plate, as the screwhead "A" on bridge must pass through hole in flyback lever. Now place bridge in proper position, and replace beveled countersink screw BS-4 to hold bridge in place.

**C. HAZARDS IN ASSEMBLY OF HOUR FLYBACK LEVER BRIDGE:**

Before replacing screw, check to see that screwhead "A" in bridge has passed through hole in flyback lever and into hole in plate. Failure to have this screw in the proper place will cause the mechanism not to work properly, or may result in bending the bridge when beveled countersink screw is replaced.

**D. FUNCTION OF HOUR FLYBACK LEVER BRIDGE:**

The function of this bridge is to hold the hour flyback lever and the connecting flyback mechanism in the correct position, so this mechanism can function properly.

**REFERENCE:** Hour flyback lever is Assembly 26.

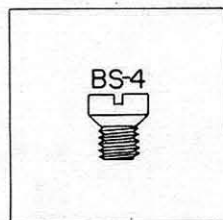

Hour Flyback Lever Bridge  
Assembly 25

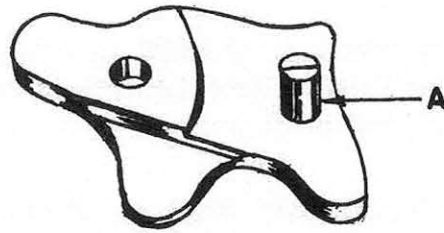

OILING

Head of screw 'A' in flyback lever bridge should be slightly moistened with oil.

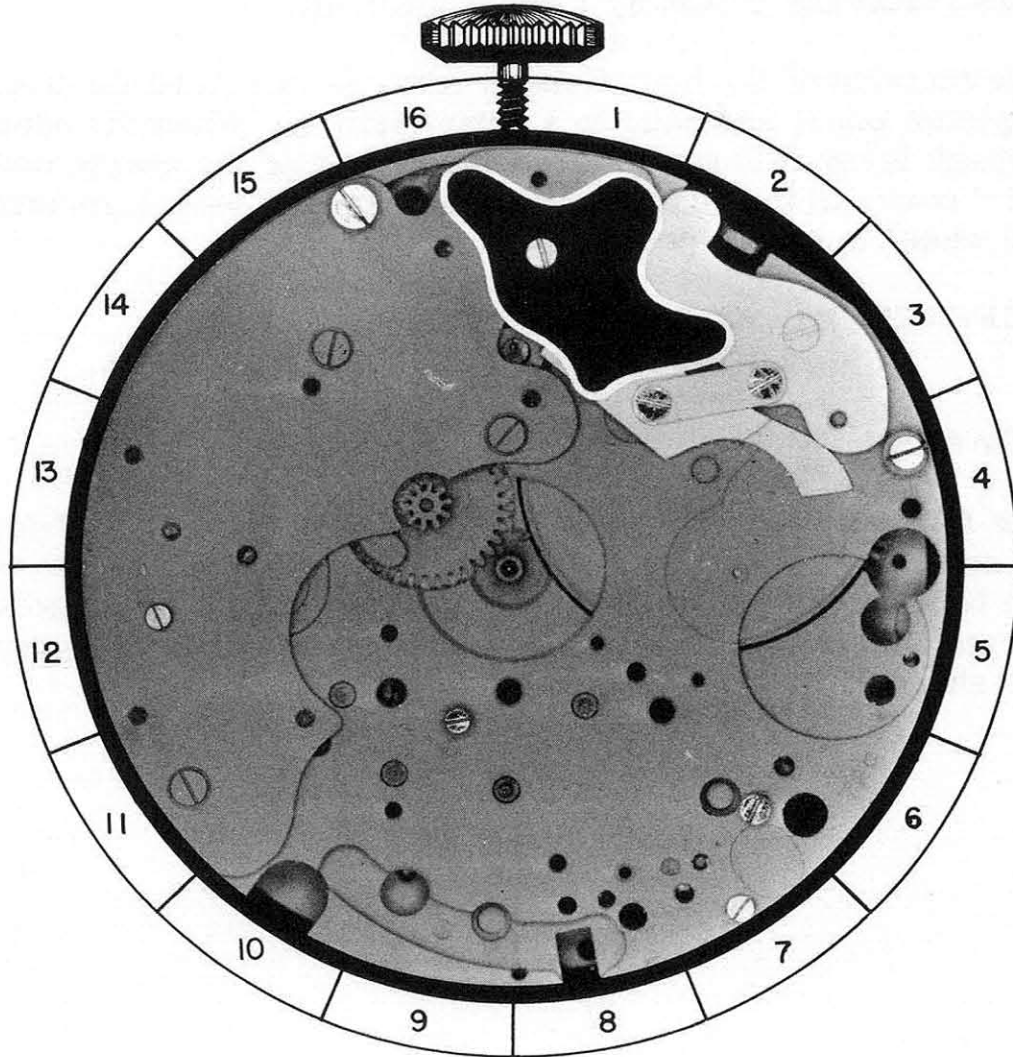

25-A

**A. DISASSEMBLY PROCEDURE OF HOUR FLYBACK LEVER:**

The hour flyback lever is now held in place by shouldered screw SS-16. When this screw is removed, the flyback lever may be lifted out of place.

(The shape of screw for this part is shown at bottom of page.)

**B. ASSEMBLY PROCEDURE OF HOUR FLYBACK LEVER:**

Place the hour flyback lever in position on the plate, with the hole in the articulation arm over the screw hole in the flyback lever, as shown in the photograph. Now replace shouldered screw SS-16. The flyback lever should move freely under the head of the screw.

**C. FUNCTION OF HOUR FLYBACK LEVER:**

The function of the hour flyback lever is to return the hour register wheel and hand to a zero position. When the hour flyback lever is forced toward the center of the watch, end "A" contacts the heart on the hour register wheel, forcing the wheel to a zero position.

**REFERENCE:** Articulation arm is Assembly 27.  
Hour register wheel is Assembly 18.

**REMARKS:**

The flat end "A" of flyback lever must be highly polished, as any roughness or pits of rust at this location may cause the hour flyback lever not to function properly. When polishing the end of this lever, care should be taken not to change the shape of it.

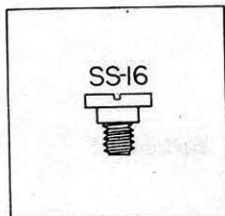

**Hour Flyback Lever  
Assembly 26**

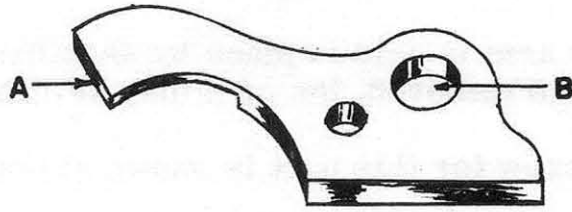

**OILING**

The screw, that hour flyback lever pivots on, should be slightly moistened with oil.

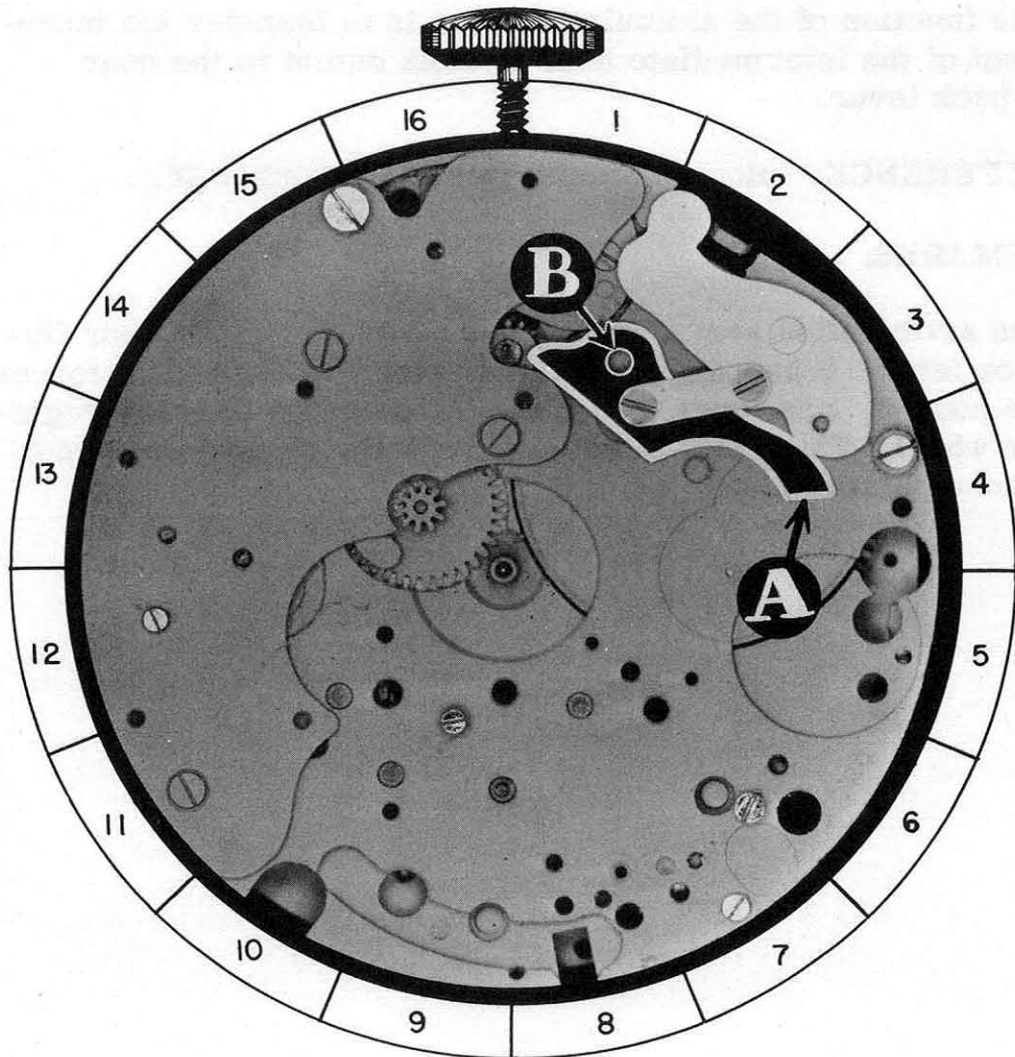

**A. DISASSEMBLY PROCEDURE OF ARTICULATION ARM:**

The articulation arm is held in place by shouldered screw SS-17. After the screw is removed, the arm may be lifted out of place.

(The shape of screw for this part is shown at bottom of page.)

**B. ASSEMBLY PROCEDURE OF ARTICULATION ARM:**

Place the articulation arm in position, with hole in the arm over the proper screw hole in the intermediate hour flyback detent, as shown in the photograph. Replace shouldered screw SS-17. Check to see that the arm pivots freely under the head of this screw.

**C. FUNCTION OF THE ARTICULATION ARM:**

The function of the articulation arm is to transfer the movement of the intermediate hour flyback detent to the hour flyback lever.

**REFERENCE:** Hour flyback lever is Assembly 26.

**REMARKS:**

The articulation arm controls the movement of the hour flyback lever. When the articulation arm is forced in, it forces the hour flyback lever to contact the heart on the hour register wheel. This causes the hour register wheel to return to a zero position.

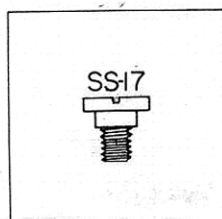

Articulation Arm  
Assembly 27

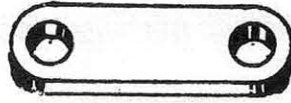

OILING

The shoulder of shouldered screws, which hold the articulation arm in place, should be slightly moistened with oil.

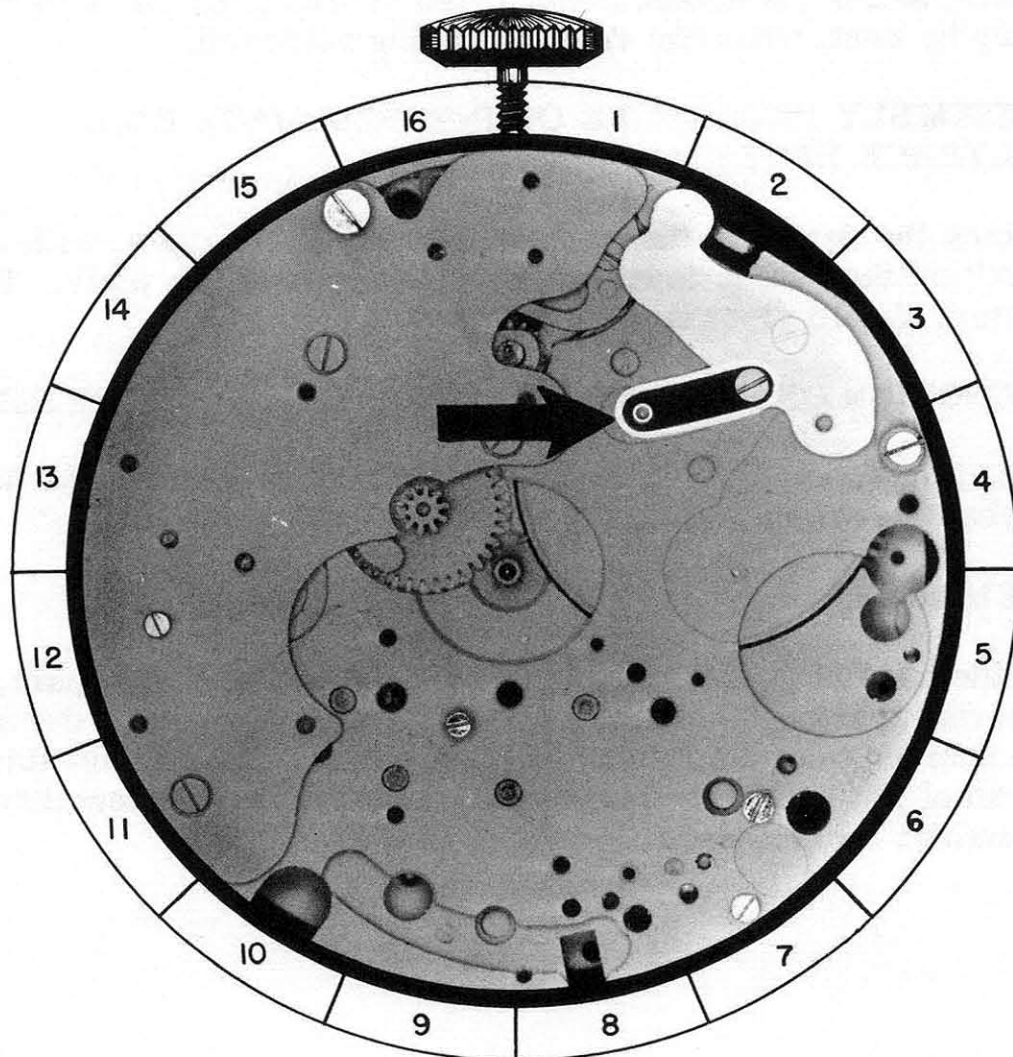

27-A



**A. DISASSEMBLY PROCEDURE OF INTERMEDIATE HOUR  
FLYBACK DETENT:**

This lever should be lifted straight up to remove it.

**NOTICE**

The removal of this part completes the disassembly of the dial side of this mechanism. Now turn the movement over, with the train side facing you, and continue to disassemble the mechanism by following the instructions in this book.

**B. HAZARDS IN DISASSEMBLY OF INTERMEDIATE HOUR  
FLYBACK DETENT:**

The stud "A" attached to the detent fits down in a hole in the plate, and if the detent is not lifted straight up, the stud "A" may be bent, when the detent is being removed.

**C. ASSEMBLY PROCEDURE OF INTERMEDIATE HOUR  
FLYBACK DETENT:**

Place the detent in the proper position on the plate, with stud "A" on the detent down in the proper hole in the plate. This detent should pivot freely on this stud.

**D. FUNCTION OF INTERMEDIATE HOUR FLYBACK DETENT:**

The function of this detent, when pushed, is to move the hour flyback lever in toward the center of the watch.

**REMARKS:**

If the head of a shouldered screw tightens down on a part, preventing it from functioning properly, the shoulder of the screw is shorter than the thickness of the lever. To correct this, the head of the shouldered screw must be cut back to lengthen the shoulder on the screw.

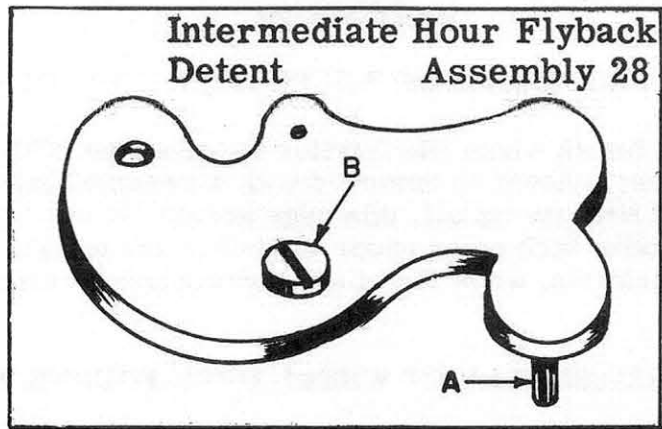

### OILING

The stud "A", on which the intermediate hour flyback detent pivots, should be slightly moistened with oil.

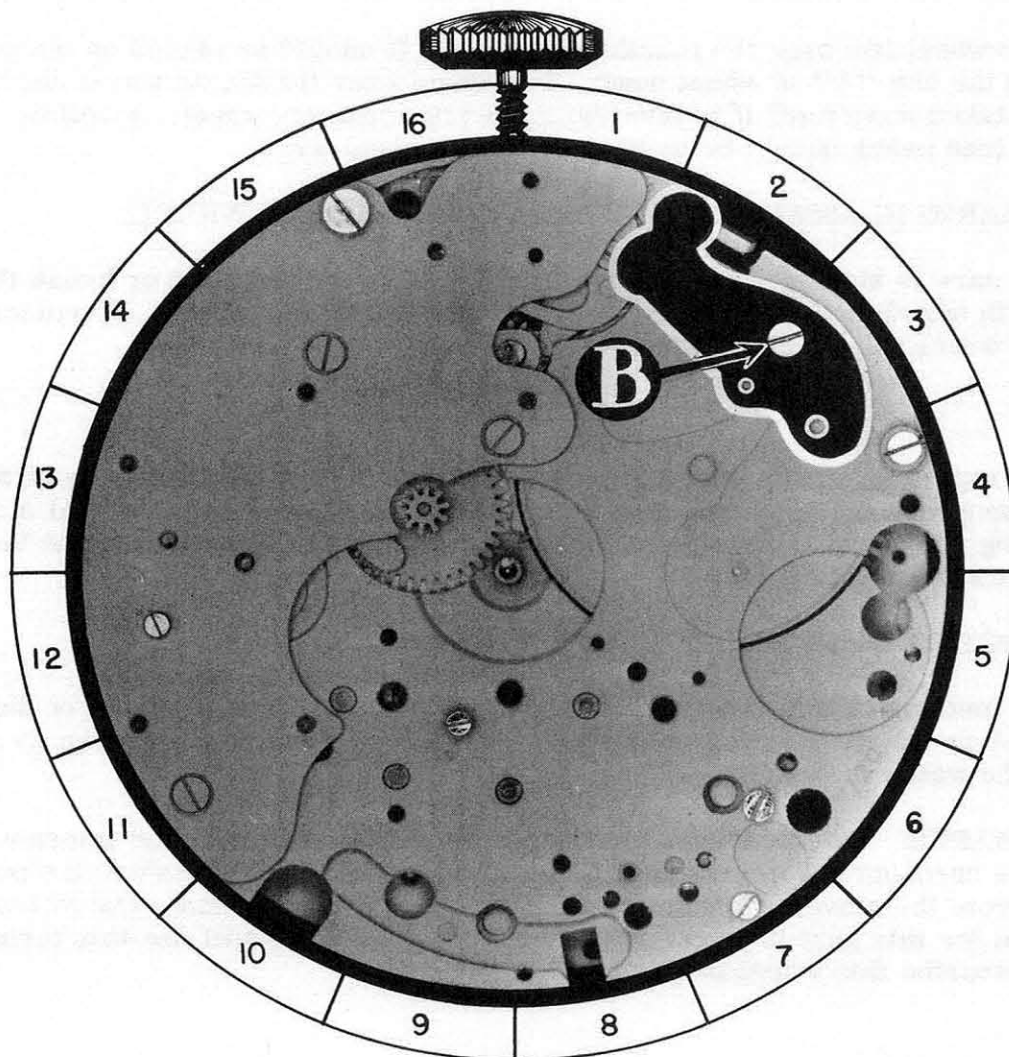

28-A

**A. DISASSEMBLY PROCEDURE OF WHEEL OVER FOURTH WHEEL:**

The wheel over fourth wheel fits friction tight on post of the fourth wheel pinion. This wheel should be removed with a sweep wheel remover, but can be removed with two small, thin edge screwdrivers. The screwdrivers are placed opposite each other under the hub of the wheel. One screwdriver is turned clockwise, while the other screwdriver is turned counter-clockwise.

**B. HAZARDS IN DISASSEMBLY OF WHEEL OVER FOURTH WHEEL:**

The wheel over fourth wheel fits over the very thin pivot of fourth wheel pinion, which is, as you know, very delicate and easily bent or broken. The main reason why we select this part to be removed first, is to lessen the hazards of bending the long pivot on the fourth wheel pinion, when removing the other parts of the chronograph mechanism. If the sweep wheel remover is held perfectly upright in removing this wheel, hazard of bending the fourth wheel pivot will be eliminated.

**C. ASSEMBLY PROCEDURE OF WHEEL OVER FOURTH WHEEL:**

This wheel fits over the fourth wheel post. It should be placed on the post with the hub "A" of wheel down. The wheel over the fourth wheel should be staked down until it is level with the intermediary wheel. A hollow, flat face punch should be used to stake the wheel down.

**D. HAZARDS IN ASSEMBLY OF WHEEL OVER FOURTH WHEEL:**

Use care in staking down this wheel, so that you do not bend or break the fourth wheel post. If the movement is held level, the hazards of replacing this wheel will be eliminated.

**NOTICE**

The replacing of this part completes the assembly of the train side of the chronograph mechanism. Now turn the movement over with the dial side facing you, and continue to assemble the mechanism by following the instructions in this book.

**E. FUNCTION OF WHEEL OVER FOURTH WHEEL:**

The function of this wheel is to transmit the power from the train of the watch to the chronograph mechanism. This wheel continues to turn as long as the watch is running.

**REMARKS:** Mechanically, we should regard this wheel as the intermediate chronograph wheel, as it is the main wheel which transfers the power from the movement train to the chronograph mechanism. The Swiss term for this part is wheel over fourth wheel, and we will use this term to describe this wheel in this text.

Wheel Over Fourth Wheel  
Assembly 29

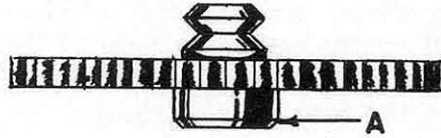

OILING

The wheel over the fourth wheel should not be oiled.

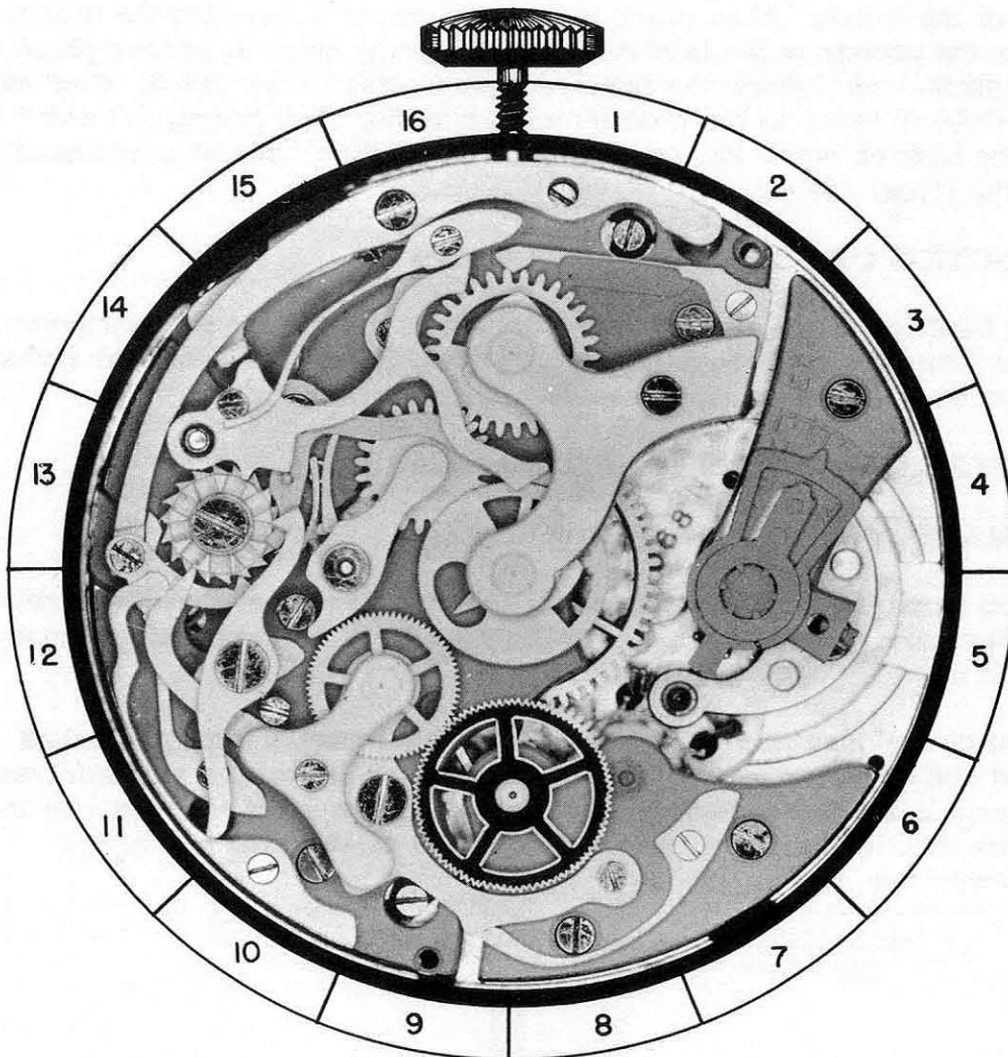

**A. DISASSEMBLY PROCEDURE OF FLYBACK LEVER SPRING:**

To remove this spring, first, release the tension on it, by lifting the end "A" and placing it on the opposite side of the screwhead "C" on the flyback lever. Now, remove the beveled countersink screw BS-5, and loosen the spring from the plate, by sliding a thin-blade screwdriver between the spring and the plate. When the steady pins are free in the plate, the spring may be lifted from the watch.

(The shape of screw for this part is shown at the bottom of the page.)

**B. HAZARDS IN DISASSEMBLY OF FLYBACK LEVER SPRING:**

The screwdriver should be carefully used when loosening the spring from the plate, to prevent marring of plate or spring.

**C. ASSEMBLY PROCEDURE OF FLYBACK LEVER SPRING:**

To replace this spring, first move the flyback lever in toward the center of the watch. Then place the spring on the plate with the steady pins over the proper holes in plate. Press spring down to proper place on the plate, and replace the beveled countersink screw BS-5. Now move the flyback lever to the position shown in the photograph, lift end "A" of the flyback lever spring, and place it on the inside of screwhead "C" on the flyback lever.

**D. FUNCTION OF FLYBACK LEVER SPRING:**

The function of the flyback lever spring is to hold the flyback lever away from the center of the watch. Also, the spring holds the flyback lever down on the post, preventing it from riding up.

**REFERENCE:** Flyback lever is Assembly 31.

**REMARKS:**

When repairing a chronograph, it is most important that the screwdrivers are properly sharpened and the correct size of screwdriver blade used for each screw slot.

Most of the screws used in the chronograph have a highly polished head and are very easily marred by a slight slip of the screwdriver. To repair a chronograph and have these screwheads marred will indicate carelessness, either in sharpening of or in the use of the screwdriver.

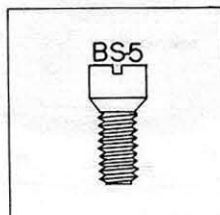

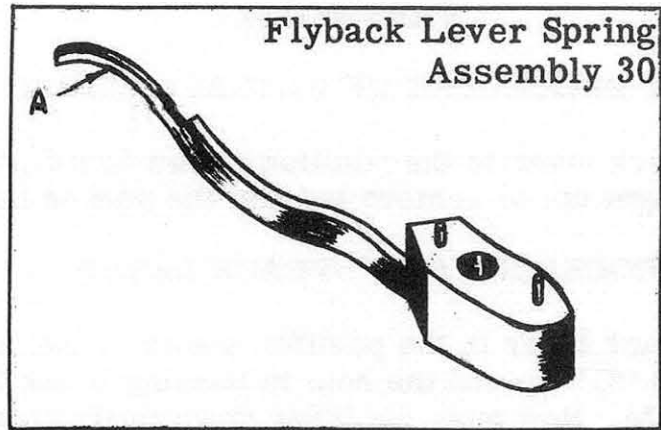

### OILING

The A end of the flyback lever spring should be slightly moistened with oil at the point it contacts flyback lever.

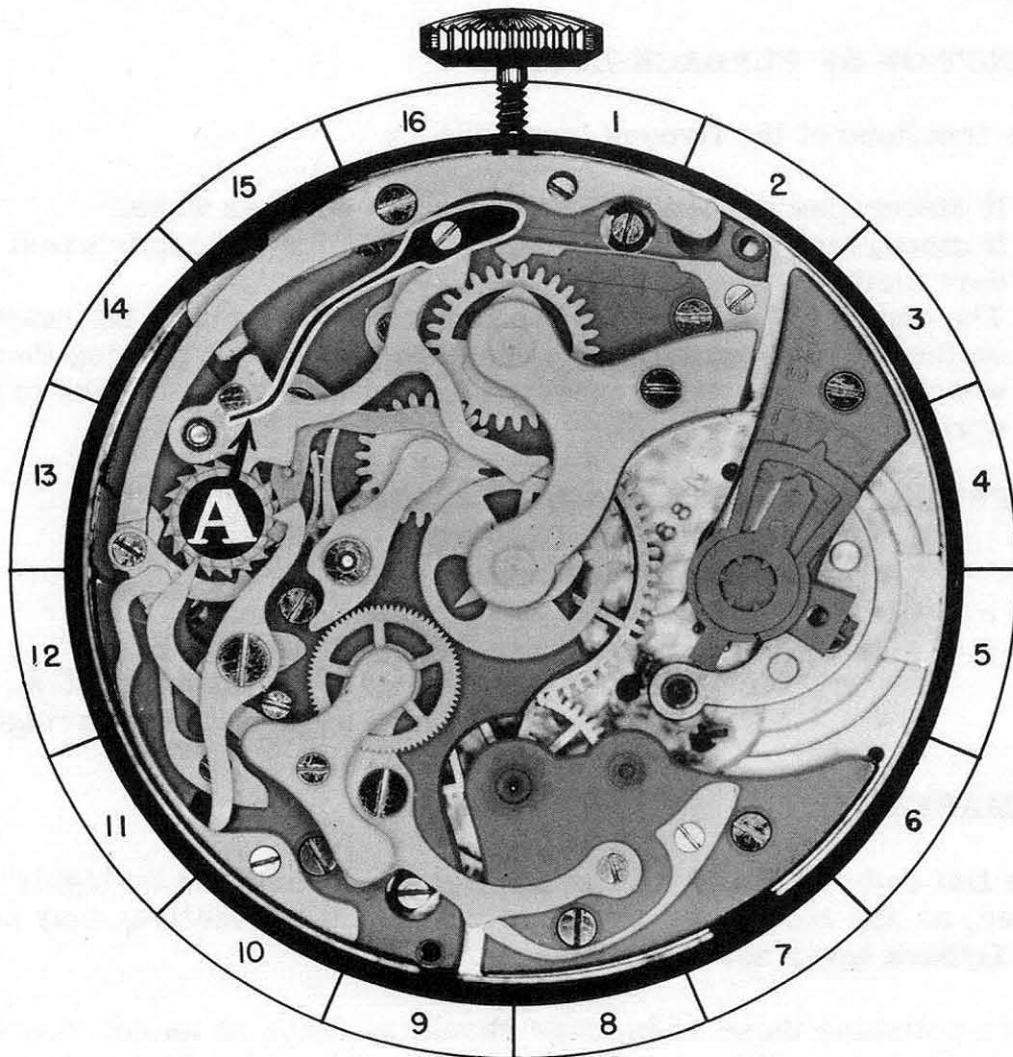

30-A

**A. DISASSEMBLY PROCEDURE OF FLYBACK LEVER:**

Move the flyback lever to the position shown in the photograph. Then lift straight up, to remove it from the post in the plate.

**B. ASSEMBLY PROCEDURE OF FLYBACK LEVER:**

Place the flyback lever in the position shown in the photograph, with the screwhead "C" up and the hole in bushing in the lever over the post in the plate. Now push the lever down to its proper place on the post.

**C. HAZARDS IN ASSEMBLY OF FLYBACK LEVER:**

When pressing the flyback lever down in position, be sure that end "B" of the lever does not catch on the seconds wheel and minute register wheel bridge, as this may cause damage to the flyback lever.

**D. FUNCTION OF FLYBACK LEVER:**

The functions of the flyback lever are:

1. It disengages the brake lever from the seconds wheel.
2. It disengages the intermittent wheel from the seconds wheel dart tooth.
3. The ends "A" and "B" of the flyback lever contact the hearts on the minute register wheel and seconds wheel, forcing these wheels and the hands connected to these wheels to return to a zero position.

**REFERENCE:** Brake lever is Assembly 37.  
Seconds wheel is Assembly 33.  
Intermittent wheel is Assembly 39 A.  
Seconds wheel dart tooth is Assembly 33 C.  
Seconds wheel heart is Assembly 33 B.  
Minute register wheel heart is Assembly 35 A.  
Seconds wheel and minute register wheel bridge is  
Assembly 32.

**REMARKS:**

The flat ends "A" and "B" of the flyback lever must be highly polished, as any roughness or pits of rust at these locations may cause the flyback lever not to function properly.

When polishing these ends, care should be taken so as not to shorten one end more than the other, or they will not function correctly.

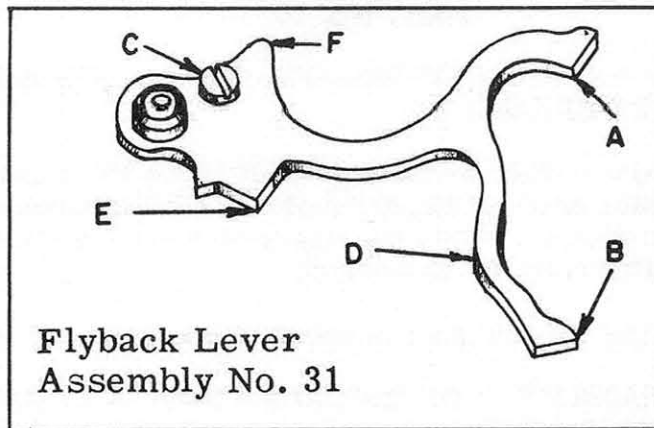

Flyback Lever  
Assembly No. 31

The following points on the flyback lever should be slightly moistened with oil:

1. The stud on which the flyback lever pivots.
2. Surface "D" which contacts intermittent lever.
3. Point "E" which contacts pin "C" on the brake lever.
4. Point "F" which contacts push piece for setting back to zero.

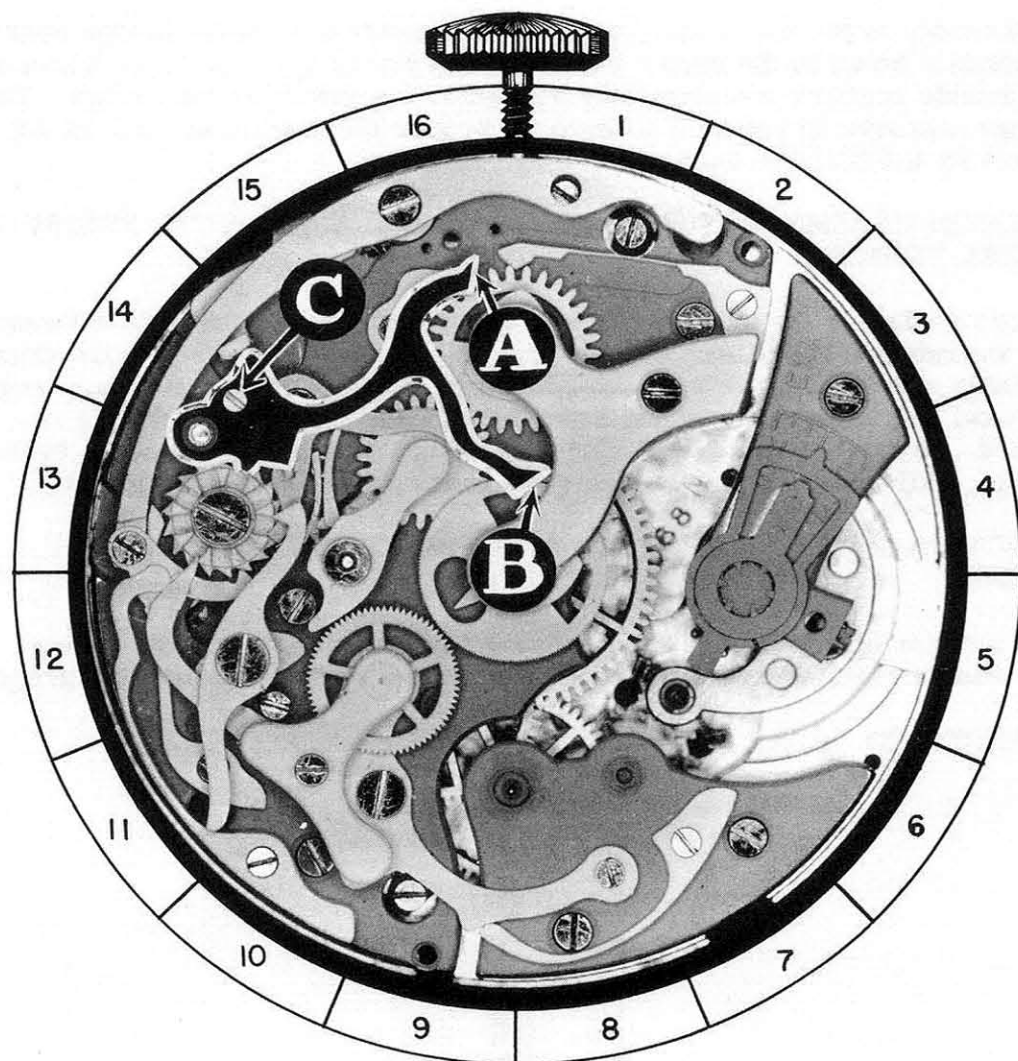



**A. DISASSEMBLY PROCEDURE OF SECONDS WHEEL AND MINUTE REGISTER WHEEL BRIDGE:**

This bridge is held in place by fillister head screw FS-2 and steady pins. Remove the fillister head screw, and loosen the bridge from the plate with a thin-blade screwdriver. When the steady pins are free in the plate, the bridge may be lifted from the movement.

(The shape of screw for this part is shown at the bottom of the page.)

**B. HAZARDS IN DISASSEMBLY OF SECONDS WHEEL AND MINUTE REGISTER WHEEL BRIDGE:**

When removing the bridge from the plate, do not twist the bridge, or it may damage the pivots on the wheels or chip the jewels in the bridge. The screwdriver should be carefully used in this operation, to prevent the marring of the bridge or the plate.

**C. ASSEMBLY PROCEDURE OF SECONDS WHEEL AND MINUTE REGISTER WHEEL BRIDGE:**

This bridge is placed on the plate with the steady pins in the bridge over the proper holes in the plate. Place the top pivots of the seconds wheel and the minute register wheel so they will enter the jewels in the bridge. The bridge may now be pressed down to its proper place with the back of the tweezers and fillister head screw FS-2 replaced.

**D. HAZARDS IN ASSEMBLY OF SECONDS WHEEL AND MINUTE REGISTER WHEEL BRIDGE:**

Before replacing the bridge, check to see that the brake lever is not under the seconds wheel and that the minute register pawl is not under the minute register wheel. Failure to make this check may result in the minute register pawl and the seconds wheel being bent, while the bridge is being replaced. The top pivots on these wheels should be in the jewel holes in the bridge, while pressing the bridge down to its proper place on the plate.

**E. FUNCTION OF SECONDS WHEEL AND MINUTE REGISTER WHEEL BRIDGE:**

The function of this bridge is to hold the top pivots of the seconds wheel and minute register wheel in position, so these wheels can function properly.

**REFERENCE:** Brake lever is Assembly 37.  
Seconds wheel is Assembly 33.  
Minute register wheel is Assembly 35.  
Minute register pawl is Assembly 36.

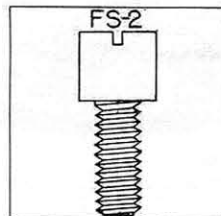

Seconds Wheel and Minute  
Register  
Wheel  
Bridge



Assembly 32

### OILING

The pivots in the jewels in this bridge should be oiled as you would properly oil the train pivots in a watch.



32-A

**A. DISASSEMBLY PROCEDURE OF SECONDS WHEEL:**

The seconds wheel is simply lifted out of place.

**B. ASSEMBLY PROCEDURE OF SECONDS WHEEL:**

The seconds wheel is placed in the watch with the long post "A" down in the hollow center wheel pinion. The brake lever should be moved out slightly, so the seconds wheel does not set on top of the brake lever.

**C. HAZARDS IN ASSEMBLY OF SECONDS WHEEL:**

Failure to move the brake lever from under the wheel may result in the wheel being bent, when the bridge is replaced.

**D. FUNCTION OF SECONDS WHEEL:**

The function of this wheel is to register the seconds on the dial by means of a hand being attached to the seconds wheel post. Also the seconds wheel must move the minute register wheel forward one tooth, each time the seconds wheel makes one revolution. This is done by a dart tooth attached to the seconds wheel. This dart tooth meshes with the teeth on the intermittent wheel, which in turn, moves the minute register wheel. The heart "B" is used to return the seconds wheel and hand to a zero position.

**REFERENCE:** Intermittent wheel is Assembly 39 A.  
Minute register wheel is Assembly 35.

**REMARKS:**

The hearts on the seconds wheel and minute register wheel must be highly polished, as any roughness or pits of rust may prevent the flyback lever from returning the seconds wheel or minute register wheel to a zero position. When polishing these hearts, care should be taken that the shape of the heart is not changed.

These hearts should be tested to see that they are secure to the wheels. The hearts being loose on the wheels may result in one or both of the wheels not returning to a zero position, when the flyback lever is brought in toward the center of the watch.

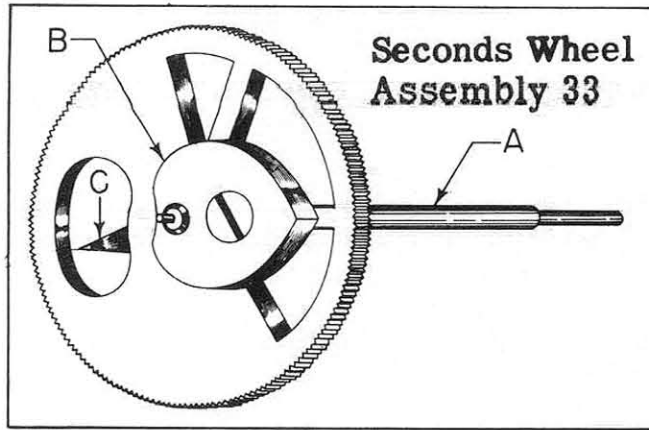

### OILING

The top pivot of the seconds wheel should be oiled, after bridge for this wheel is placed in watch.

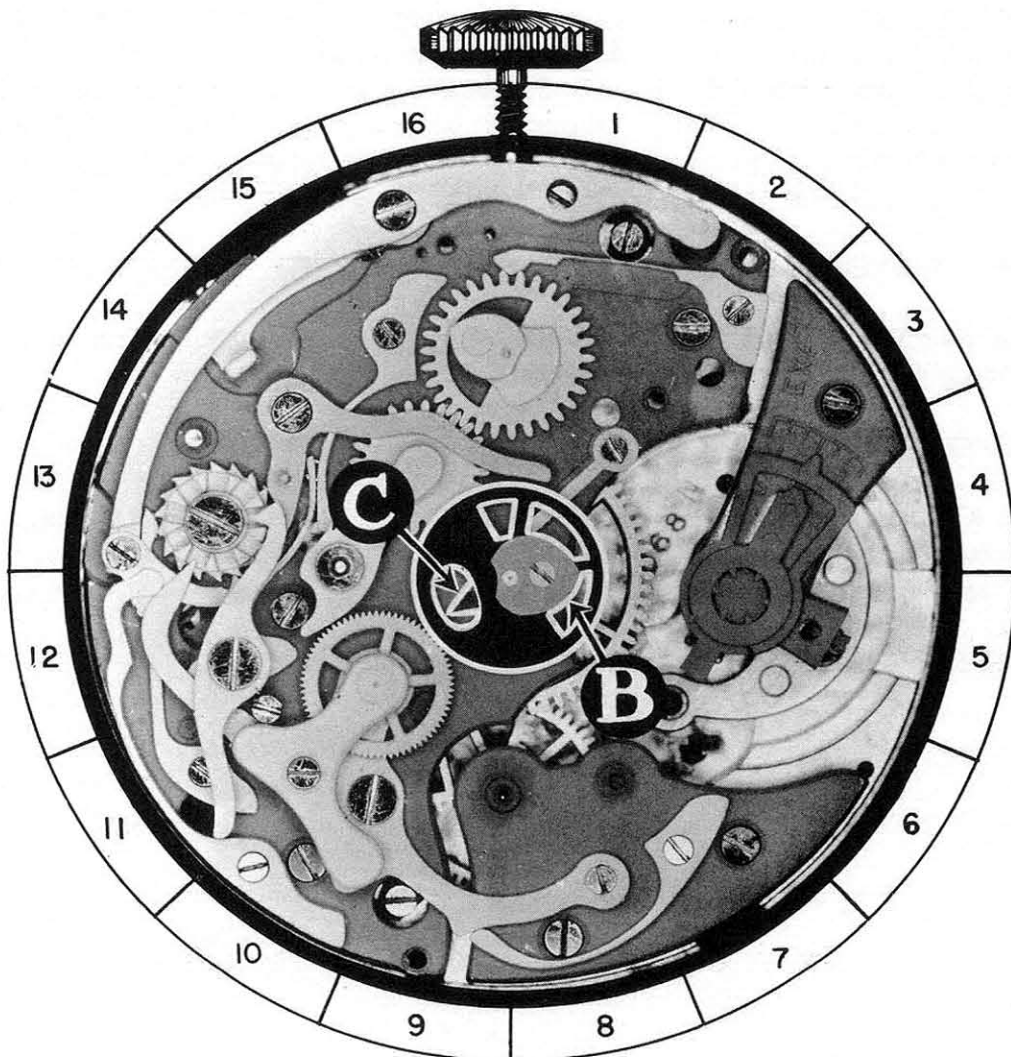

PART NO. 34

**A. DISASSEMBLY PROCEDURE OF SECONDS WHEEL TENSION SPRING:**

The seconds wheel tension spring is held in place by fillister head screw FS-3. When this screw is removed, the tension spring will be free on the plate, and can be lifted out of place.

(The shape of screw for this part is shown at the bottom of page.)

**B. HAZARDS IN DISASSEMBLY OF SECONDS WHEEL TENSION SPRING:**

Be careful in removing this spring. It is a very thin, soft spring and is easily damaged.

**C. ASSEMBLY PROCEDURE OF SECONDS WHEEL TENSION SPRING:**

Place the tension spring in position on the plate, with the hole in the spring over the proper screw hole. Make sure that the right side of the spring is up, so end "A" rises above the level of the plate. Replace fillister head screw FS-3, but before this screw is tightened, place the end "A" of the spring, so it is along the side of the hole in hollow staff of the center wheel. Now tighten fillister head screw FS-3, and check to see that the spring is still in proper position.

**D. HAZARDS IN ASSEMBLY OF SECONDS WHEEL TENSION SPRING:**

The seconds wheel tension spring is a thin, soft spring and is easily damaged. Use care when replacing this spring.

**E. FUNCTION OF SECONDS WHEEL TENSION SPRING:**

1. It holds a tension on the seconds wheel, so while this wheel is turning, it has a smooth action with no irregular jumping or jerking.

**REFERENCE:** Seconds wheel is Assembly 33.

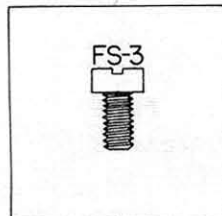

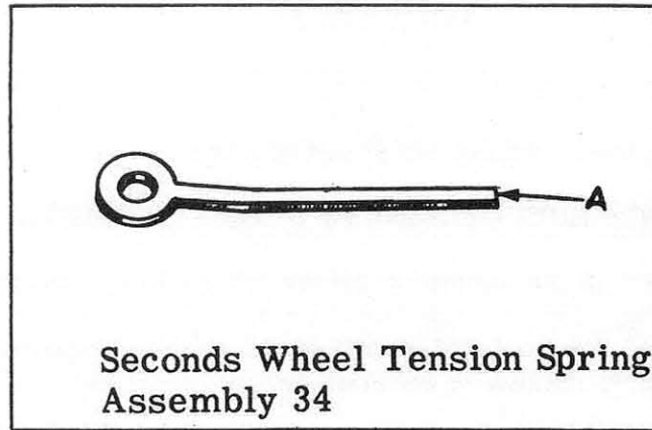

### OILING

Seconds wheel tension spring should not be oiled.

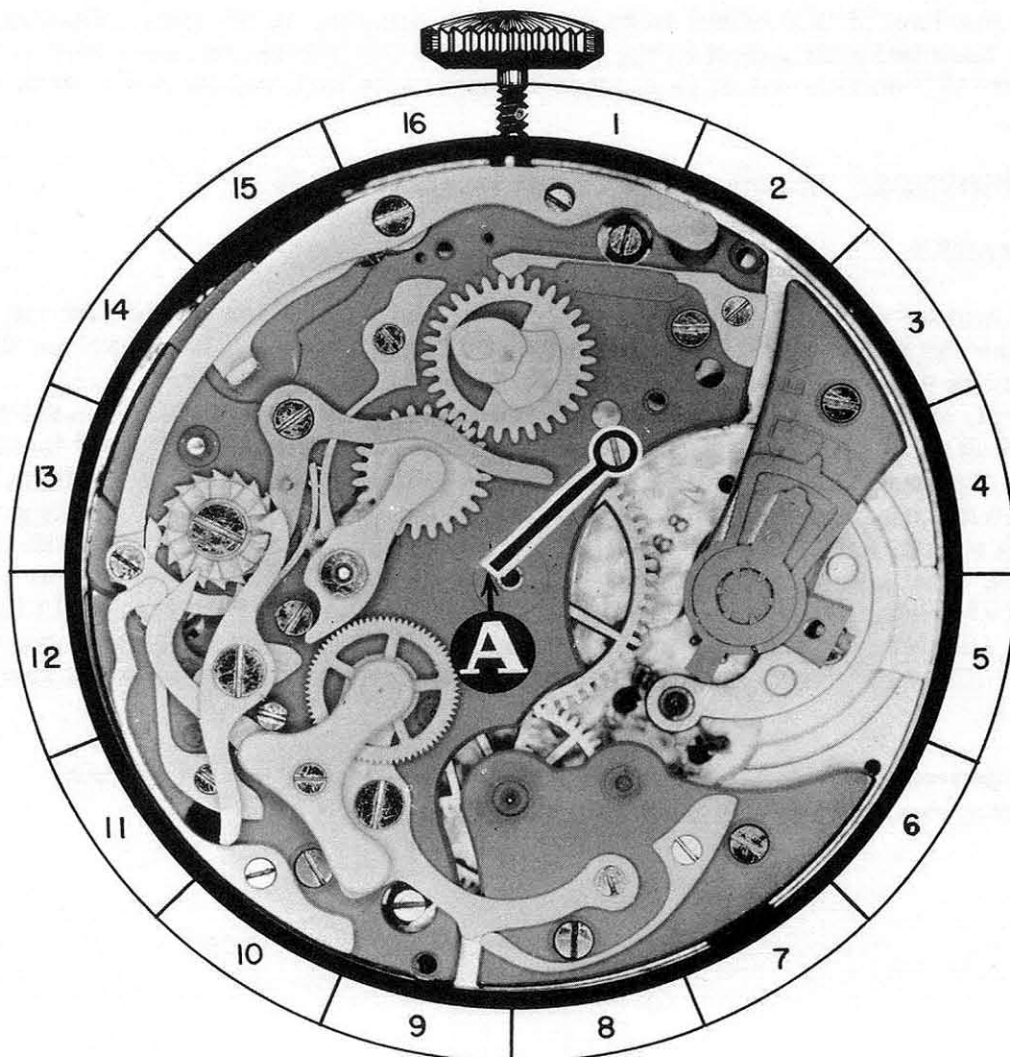

34-A

**A. DISASSEMBLY PROCEDURE OF MINUTE REGISTER WHEEL:**

To remove this wheel, simply lift it out of place.

**B. ASSEMBLY PROCEDURE OF MINUTE REGISTER WHEEL:**

The long post "B" of the minute register wheel should be placed down in the hole in the bushing. The minute register pawl should be moved so the minute register wheel does not set on top of the minute register pawl. The end "A" of the pawl should be between two teeth on the minute register wheel.

**C. HAZARDS IN ASSEMBLY OF MINUTE REGISTER WHEEL:**

Failure to move end "A" of the minute register pawl from under the minute register wheel may result in the minute register pawl being bent, when the bridge is replaced.

**D. FUNCTION OF MINUTE REGISTER WHEEL:**

The function of this wheel is to record the minutes on the dial. This is done by a hand being attached to the post "B" on the minute register wheel. The heart "A" on this wheel is used to return the wheel and hand to a zero position.

**REFERENCE:** Minute register pawl is Assembly 36.

**REMARKS:**

The minute register wheel is returned to a zero position by the flyback lever contacting the heart "A" on the minute register wheel. The heart on this wheel is set eccentric. The flat end of the flyback lever contacts the eccentric heart and forces the heart to turn. The heart will turn until the flat end of the flyback lever sets across the two lobes at the top of the heart. With the pressure equalized at these two points, it will turn no further, and this will be a zero position. If this wheel has turned less than 160 degrees from a zero position when the flyback lever is brought in contact with the heart, it will turn in the opposite direction to which it was turning, to bring this wheel back to a zero position. On the other hand, if the wheel is turned past 160 degrees from a zero position, the flyback lever will force the heart to continue to turn in the direction it was turning until it reaches a zero position.

The degree used above is approximate. This degree varies in most chronographs from 150 degrees to 170 degrees.

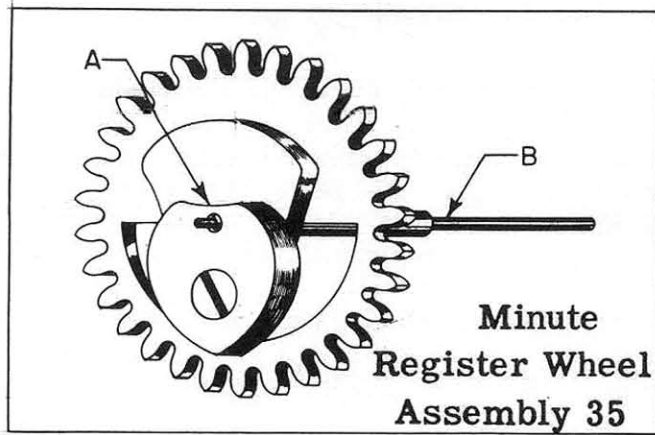

### OILING

Bottom pivot of minute register wheel should be oiled as you would normally oil a train pivot in a watch. The top pivot should be oiled, after bridge for wheel is placed in watch.

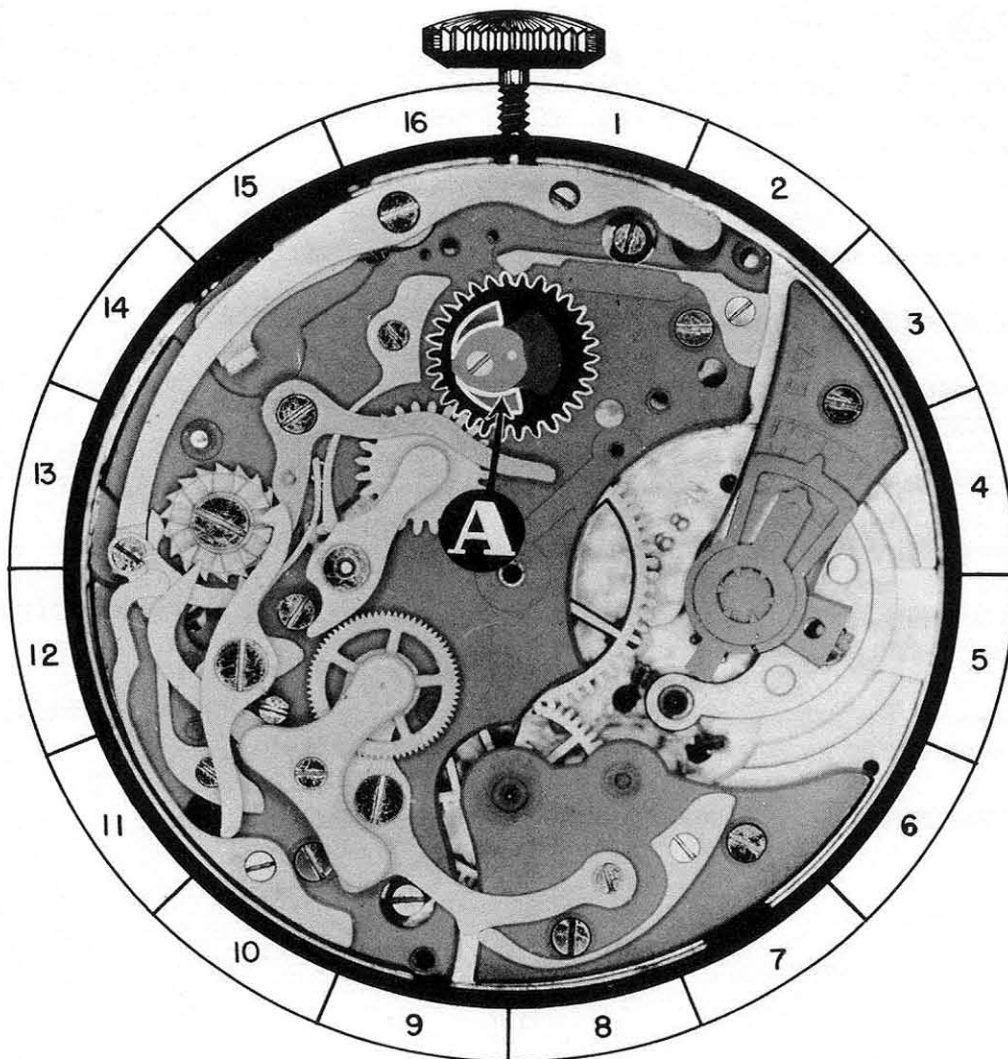

35-A



**A. DISASSEMBLY PROCEDURE OF MINUTE REGISTER PAWL:**

This pawl is held in place by beveled countersink screw BS-6 and steady pins. Remove screw, and loosen the pawl from the plate, by sliding a thin-blade screwdriver between the pawl and the plate. When steady pins are free in the plate, the pawl may be lifted from the movement.

(The shape of screw for this part is shown at the bottom of the page.)

**B. HAZARDS IN DISASSEMBLY OF MINUTE REGISTER PAWL:**

The tension spring on the pawl is very delicate and can be easily ruined by a slight slip of the screwdriver.

**C. ASSEMBLY PROCEDURE OF MINUTE REGISTER PAWL:**

Place the pawl on the plate, with the steady pins over the proper holes in the plate. Then press the pawl down to correct position, and replace beveled countersink screw BS-6.

**CAUTION:** The tension of end "A" of pawl on the minute register wheel must be very light, yet strong enough to hold the minute register wheel in a stationary position, until the wheel is turned by the chronograph mechanism. Too strong a tension at this point will cause a loss of power, or may even cause the watch to stop.

The end "A" of the pawl must be highly polished, as any pits of rust or burrs at this location will cause the pawl not to function properly.

**D. HAZARDS IN ASSEMBLY OF MINUTE REGISTER PAWL:**

The tension spring on the pawl is very delicate and can be ruined by a twist or a slip of the tool.

**E. FUNCTION OF MINUTE REGISTER PAWL:**

The functions of the minute register pawl are:

1. It holds a tension on the minute register wheel, so it moves exactly one tooth each minute.
2. It holds the minute register wheel in a stationary position, so that a bump or jar cannot alter the position of this wheel.

**REFERENCE:** Minute register wheel is Assembly 35.

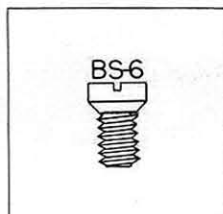

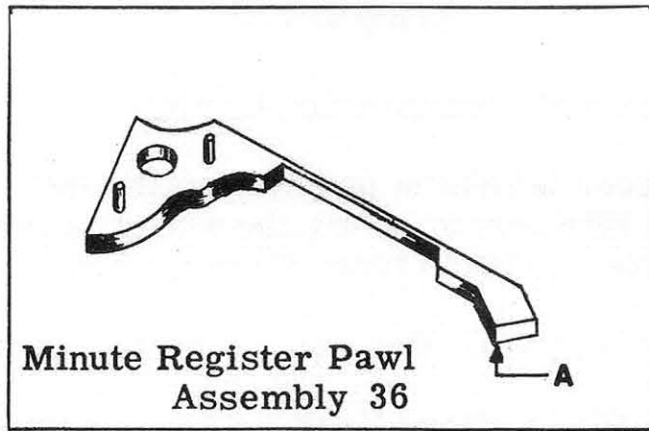

### OILING

The minute register pawl should not be oiled.

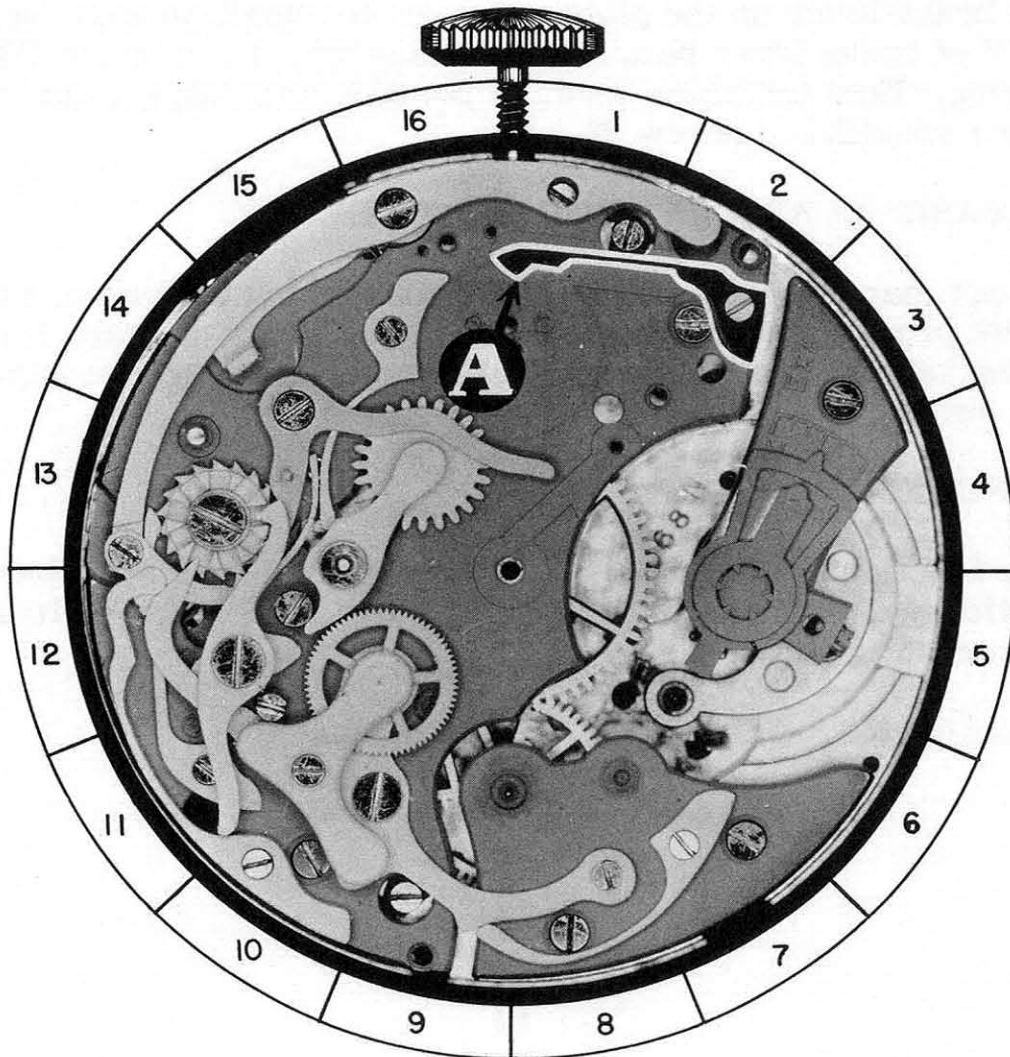

36-A

**A. DISASSEMBLY PROCEDURE OF BRAKE LEVER:**

This brake lever is held in place by shouldered screw SS-18 and pivots on this screw. After the screw is removed, the brake lever may be lifted from the movement.

(The shape of screw for this part is shown at bottom of page.)

**B. HAZARDS IN DISASSEMBLY OF BRAKE LEVER:**

Hold finger on the brake lever when removing the screw, so that the screw will not shoot away and become lost.

**C. ASSEMBLY PROCEDURE OF BRAKE LEVER:**

Place the brake lever on the plate with the pin "C" up. Slide the brake lever on the plate to its proper position with the end "A" of brake lever between the castle wheel and brake lever spring. Hold the brake lever in position with finger, and replace shouldered screw SS-18.

**D. HAZARDS IN ASSEMBLY OF BRAKE LEVER:**

Do not mar the plate or lever when replacing the brake lever to its proper place. Be sure that the end "A" of brake lever is between castle wheel and brake lever spring before replacing screw.

**E. FUNCTION OF BRAKE LEVER:**

The function of the brake lever is to hold the seconds wheel stationary, when the intermediary wheel is disengaged from the seconds wheel.

**REFERENCE:** Brake lever spring is Assembly 41.  
Castle wheel is Assembly 51.  
Intermediary wheel is Assembly 43.

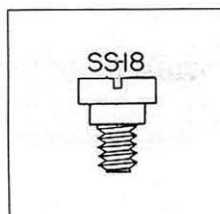

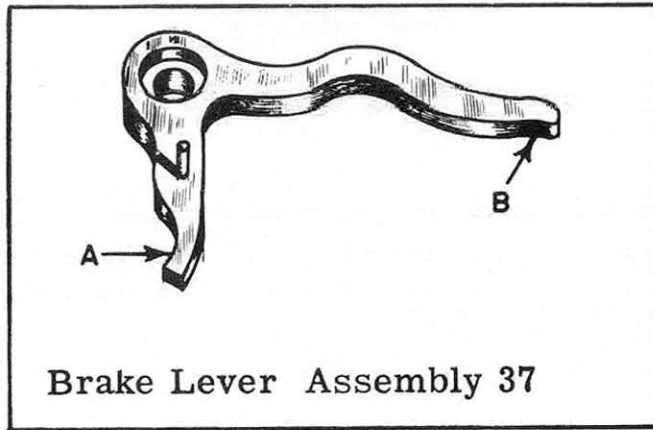

Brake Lever Assembly 37

### OILING

The shouldered screw, the brake lever pivots on, should be slightly moistened with oil.

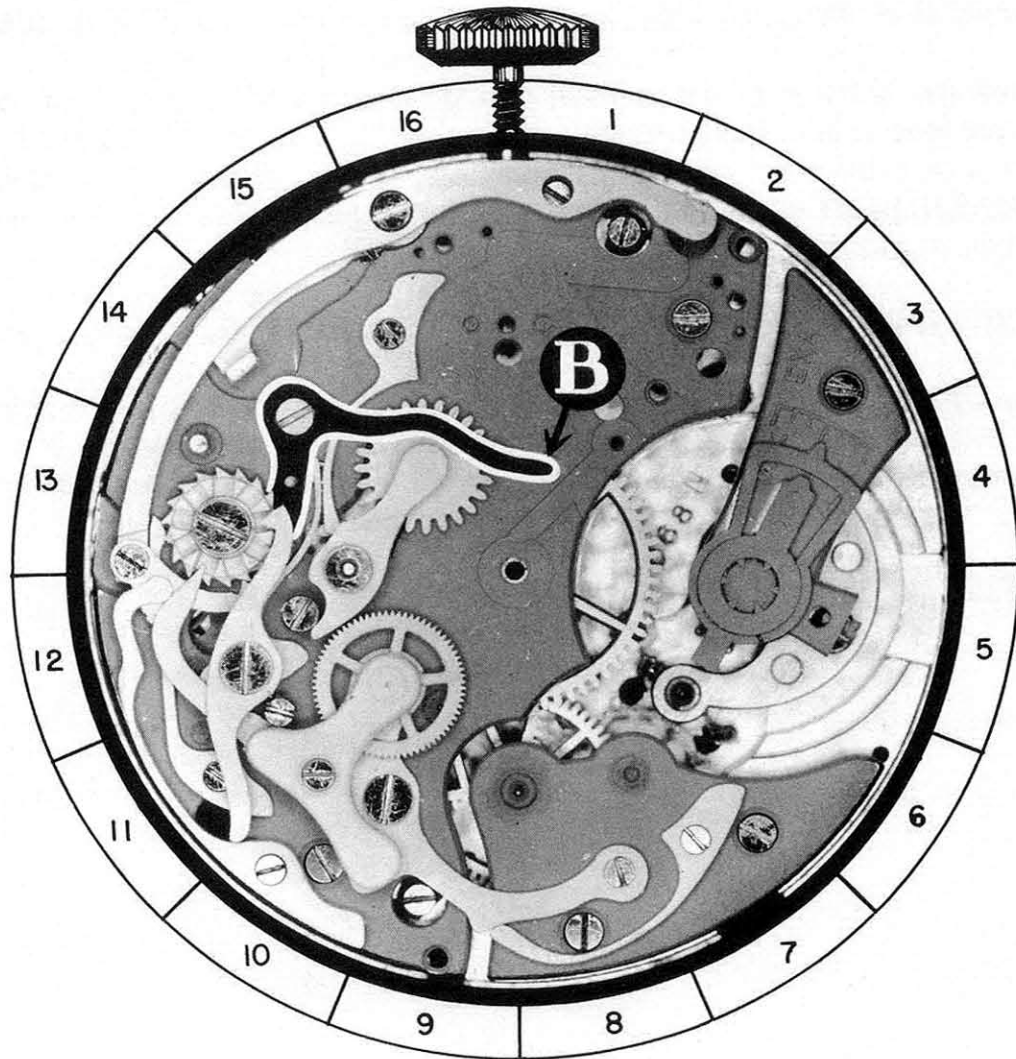

37-A

**A. DISASSEMBLY PROCEDURE OF INTERMITTENT LEVER SPRING:**

This spring is held in place by beveled countersink screw BS-7 and steady pins. Remove screw, and loosen the spring from the plate by sliding a thin blade screwdriver between the plate and the spring. When the steady pins are free in the plate, the spring may be lifted from the movement.

(The shape of screw for this part is shown at bottom of page.)

**B. HAZARDS IN DISASSEMBLY OF INTERMITTENT LEVER SPRING:**

The screwdriver should be carefully used when loosening the spring from the plate, to prevent marring of the plate or spring.

**C. ASSEMBLY PROCEDURE OF INTERMITTENT LEVER SPRING:**

Place the spring in its proper position with the steady pins over the proper holes in the plate. The end "A" of spring should be on top of part "B" of the intermittent lever. When the spring is in this position, push it down flush on plate, and replace beveled countersink screw BS-7.

**D. FUNCTION OF INTERMITTENT LEVER SPRING:**

This spring holds a tension on the intermittent lever, to engage the intermittent wheel with the seconds wheel dart tooth. It also holds the intermittent lever down on the post, preventing it from riding up on the post and coming out of place.

**REFERENCE:** Intermittent lever is Assembly 39.  
Intermittent wheel is Assembly 39 A.  
Seconds wheel dart tooth is Assembly 33 C.

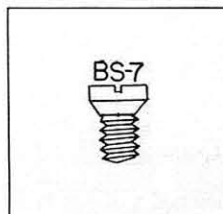

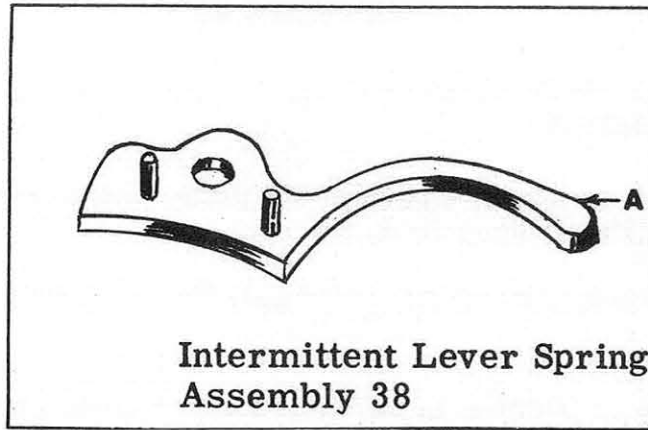

Intermittent Lever Spring  
Assembly 38

### OILING

End A of spring should be slightly moistened with oil at the point it contacts intermittent lever and wheel assembly.

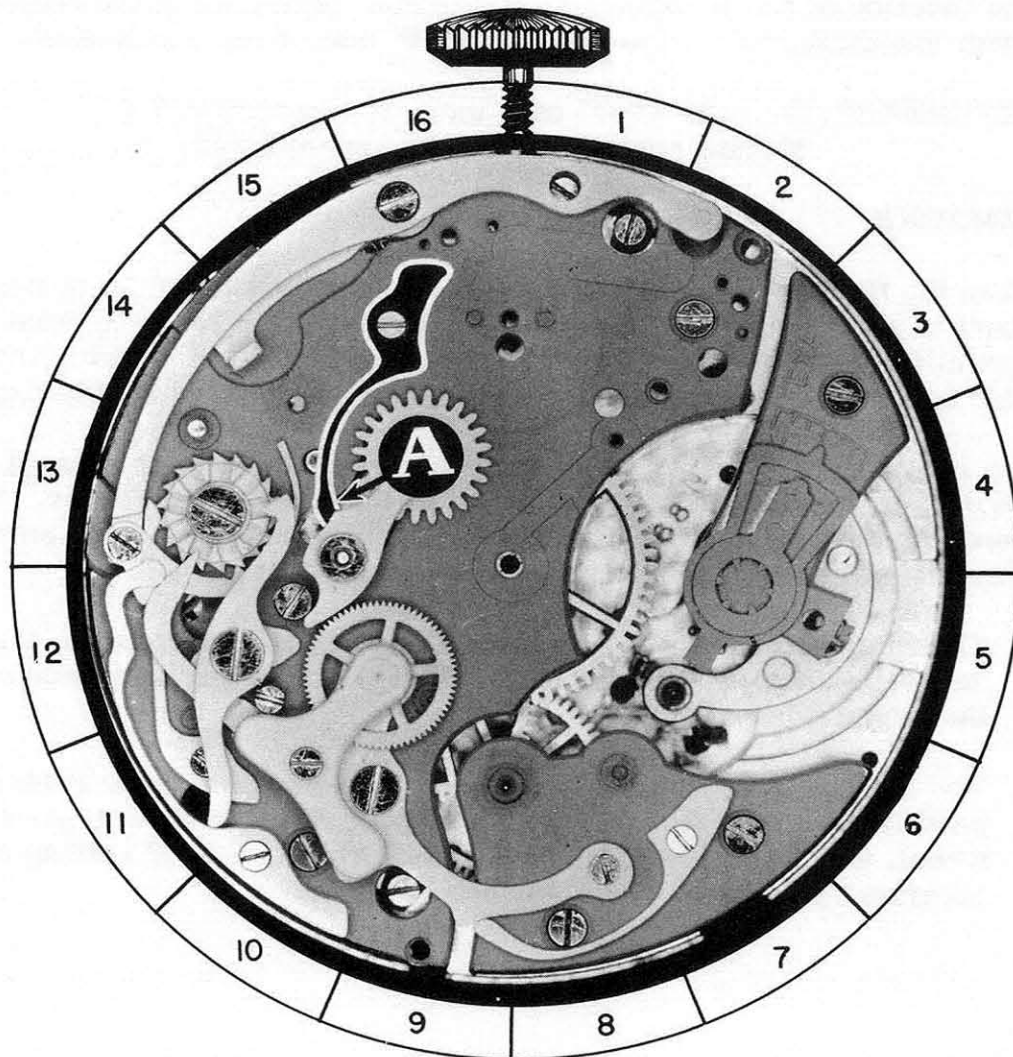

38-A

**A. DISASSEMBLY PROCEDURE OF INTERMITTENT LEVER AND WHEEL ASSEMBLY:**

This assembly pivots on a post in the plate, and to remove it, simply lift the intermittent lever from the post.

**B. ASSEMBLY PROCEDURE OF INTERMITTENT LEVER AND WHEEL ASSEMBLY:**

Place the hole in bushing in the intermittent lever over the proper post in the plate, as shown in the photograph. Now push assembly down to proper place. Assembly should pivot freely on post.

**C. FUNCTION OF INTERMITTENT LEVER AND WHEEL ASSEMBLY:**

The function of the intermittent lever is to engage and disengage the intermittent wheel with the seconds wheel dart tooth.

The function of the intermittent wheel is to turn the minute register wheel one tooth, each time the dart tooth makes one revolution.

**REFERENCE:** Seconds wheel dart tooth is Assembly 33 C.  
Minute register wheel is Assembly 35.

**REMARKS:**

When the flyback lever returns the seconds wheel and minute register wheel to a zero position, it forces the intermittent lever to move the intermittent wheel away from the center of the watch, making it impossible for the dart tooth to touch the intermittent wheel at this time.

The intermittent wheel should be carefully checked to see that it has the proper endshake and spins freely in the intermittent lever. This wheel must, of necessity, spin freely, as any excess friction on the intermittent wheel may cause the following errors:

1. The intermittent wheel, when engaging with the dart tooth, may cause the minute register wheel to turn, resulting in an error in the registering of minutes.
2. The intermittent wheel binding may prevent the minute register pawl from correctly spacing the turning of the minute register wheel, which may result in the minute register hand setting at an incorrect position.

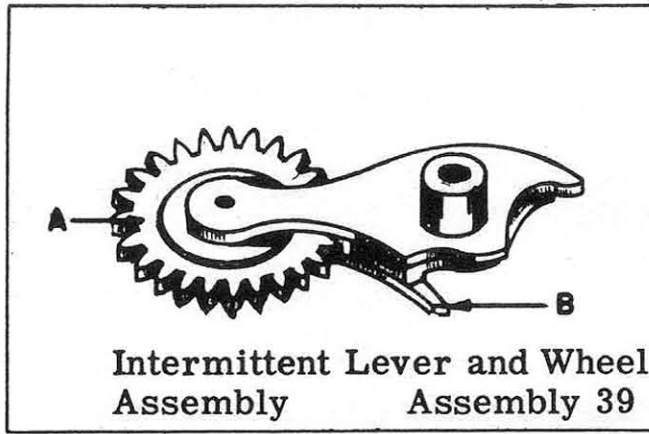

### OILING

The post, that intermittent lever and wheel assembly pivots on, should be slightly moistened with oil.

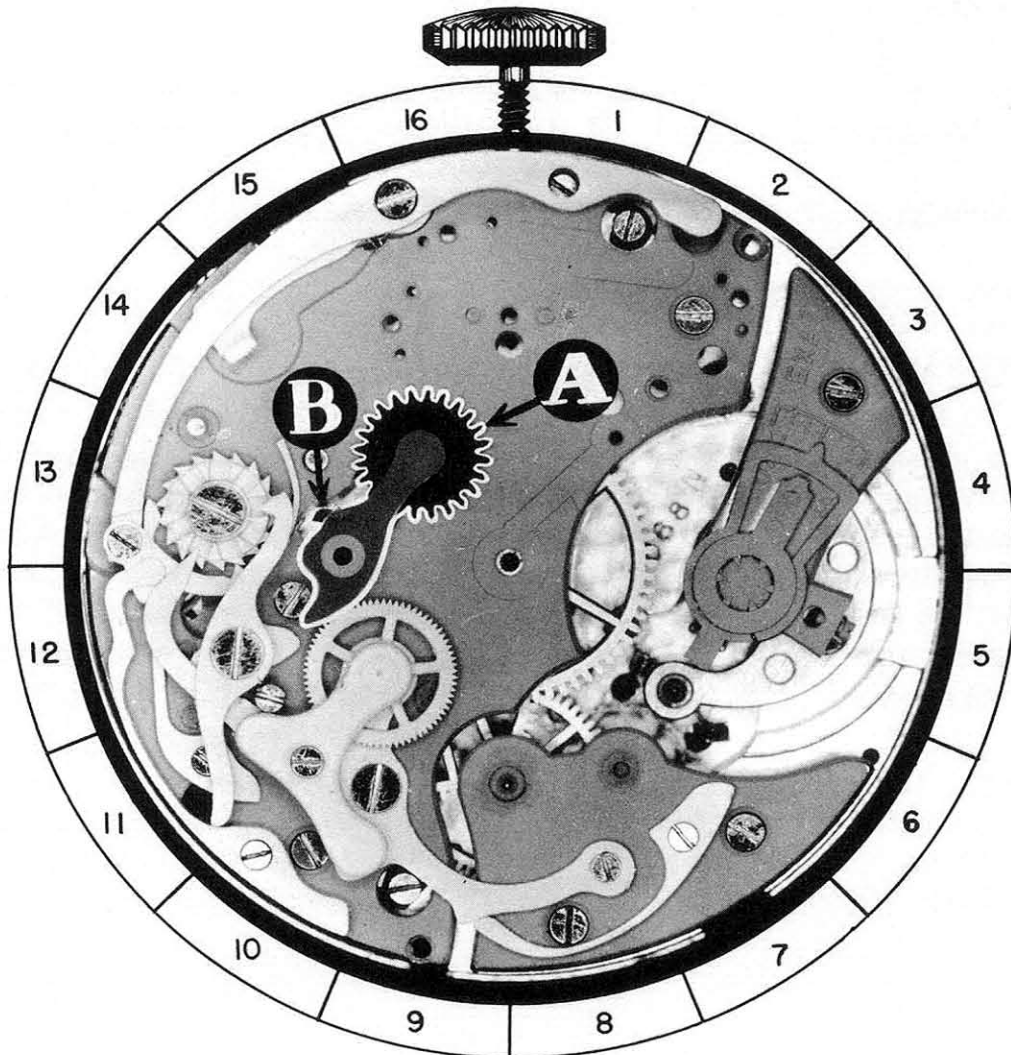



**A. DISASSEMBLY PROCEDURE OF LEVER ARM HOUR YOKE:**

This lever arm is held in place by shouldered screw SS-19, and pivots on this screw. Remove the screw, and lift the lever arm from the plate.

(The shape of screw for this part is shown at bottom of page.)

**B. ASSEMBLY PROCEDURE OF LEVER ARM HOUR YOKE:**

Place the lever arm in the proper position on the brake lever spring, as shown in the photograph. When the lever is in the proper position, replace shouldered screw SS-19. Check to see that the lever pivots freely under the head of the shouldered screw.

**C. FUNCTION OF LEVER ARM HOUR YOKE:**

The function of the lever arm hour yoke is to control the engaging and disengaging of the hour register mechanism.

REFERENCE: Brake lever spring is Assembly 41.

**D. HOW FUNCTION TAKES PLACE:**

When the chronograph mechanism is engaged, the castle wheel is in such a position which permits end "B" to enter between two columns. With the lever arm hour yoke in this position, the intermediate hour yoke and wheel is permitted to move in to engage with the hour register wheel. When the castle wheel is being turned to disengage the chronograph mechanism, end "B" of the lever arm hour yoke will be forced from between the two columns. This, in turn, causes end "A" to disengage the intermediate hour yoke and wheel from the hour register wheel.

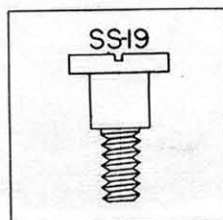

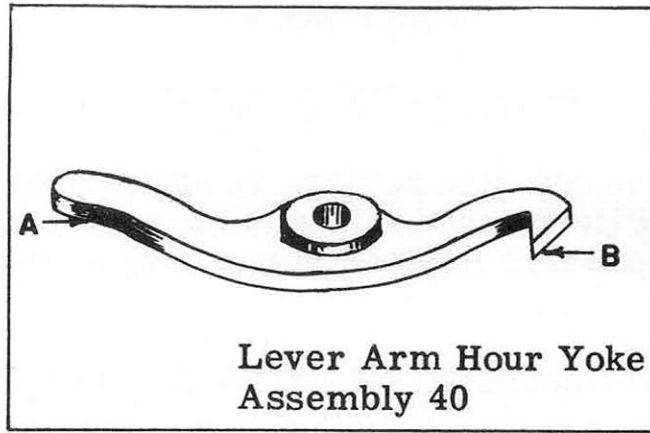

### OILING

The shouldered screw, that the lever arm pivots on, should be slightly moistened with oil.

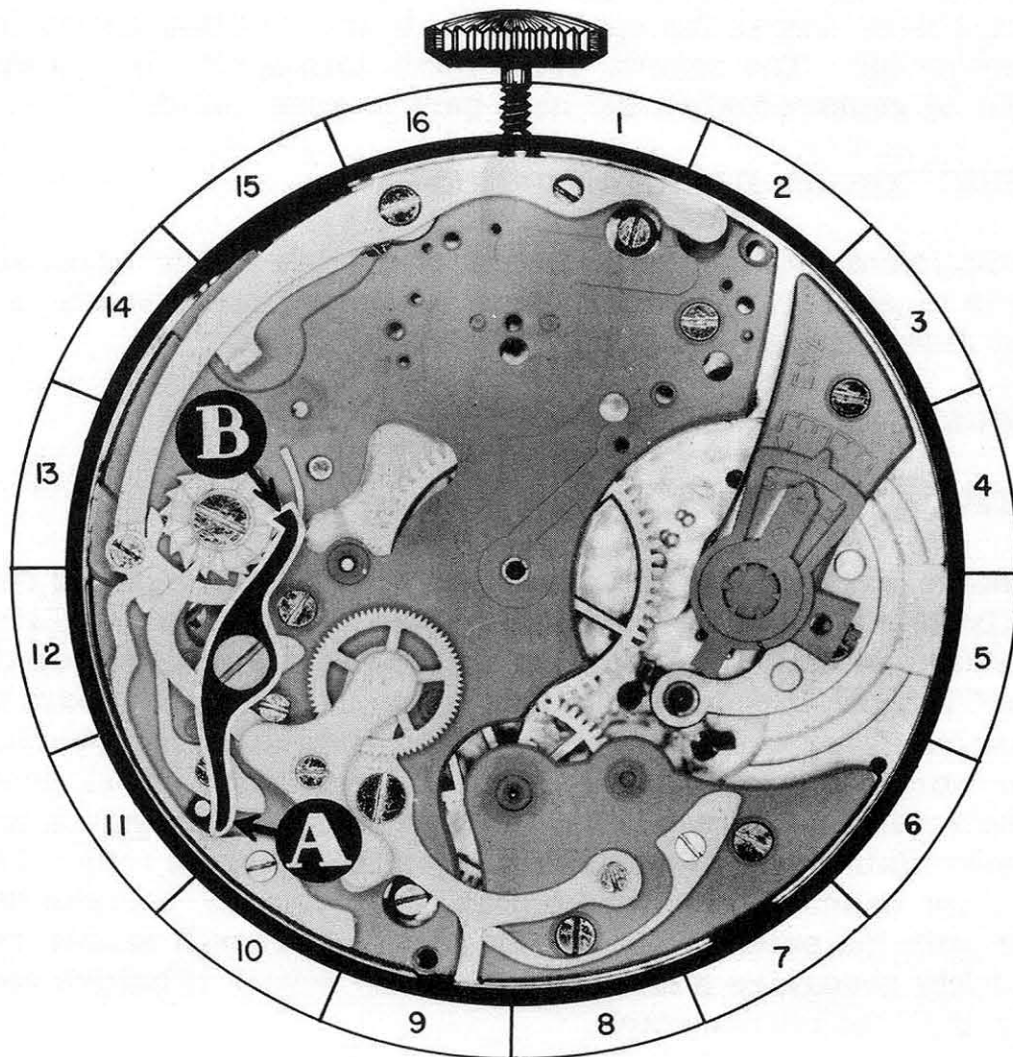

40-A

**A. DISASSEMBLY PROCEDURE OF BRAKE LEVER SPRING:**

This spring is now held in place by steady pins. Slide a thin blade screwdriver under spring to loosen it from plate. When steady pins are free in plate, spring may be lifted from the movement.

**B. HAZARDS IN DISASSEMBLY OF BRAKE LEVER SPRING:**

When loosening the spring from the plate, the screwdriver should be carefully used to prevent marring of the spring or the plate.

**C. ASSEMBLY PROCEDURE OF BRAKE LEVER SPRING:**

Place the spring on the plate with the steady pins over the proper holes. Press the spring down to the position shown in the photograph. The screw, which holds this spring in position, will be replaced when the next part is assembled.

**D. FUNCTION OF BRAKE LEVER SPRING:**

Function of this spring is to hold a tension on the brake lever. This tension forces brake lever to contact seconds wheel when not disengaged by the castle wheel.

**REFERENCE:** Seconds wheel is Assembly 33.

**REMARKS:**

When disassembling the chronograph, each part should be carefully examined as it is removed from the movement. Each part should be checked against the isometric drawing, to see that the part has the correct shape and is not broken. Each part should also be checked for any pits of rust, roughness, or burrs, and for worn parts, which may cause the part not to work properly. The replacement of a defective part in the chronograph may necessitate complete disassembly of the chronograph. Through a close examination of each part, you will soon become familiar with the parts of the chronograph. This will enable you to quickly recognize a defective part and repair it before replacing it in the chronograph.

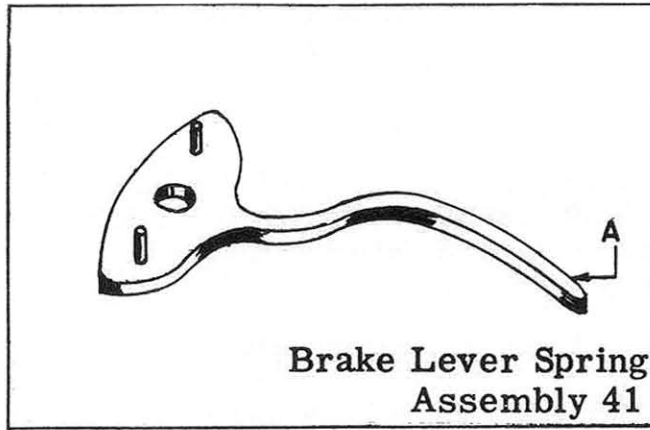

Brake Lever Spring  
Assembly 41

### OILING

End 'A' of spring should be slightly moistened with oil  
at the point it contacts seconds wheel brake lever.

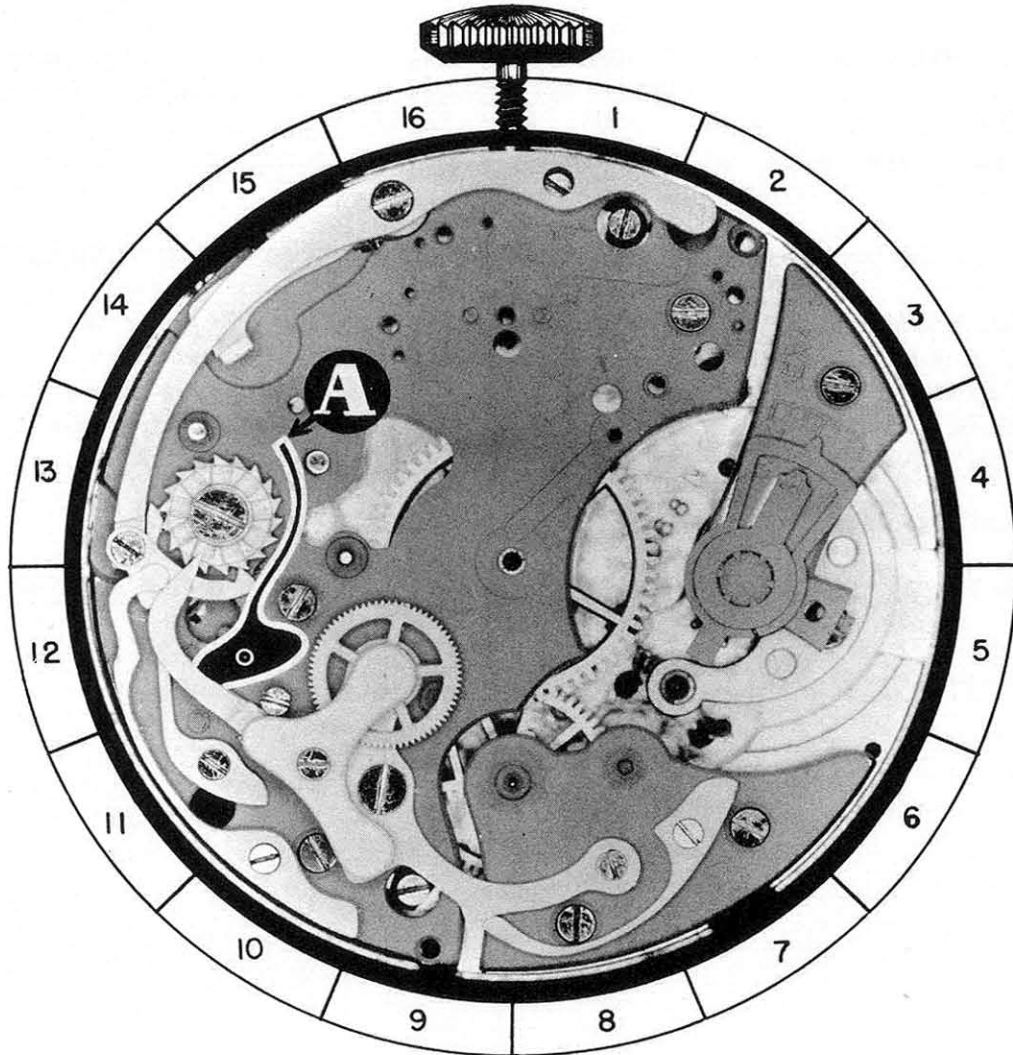

41-A

**A. DISASSEMBLY PROCEDURE OF CHRONOGRAPH PIVOTED DETENT BRIDGE:**

This bridge is held in place by chamfered flat head screw CS-1 and steady pins. Remove screw, and loosen the bridge from the chronograph pivoted detent with a thin-blade screwdriver. When steady pins are free of detent the bridge may be lifted from the movement.

(The shape of screw for this part is shown at the bottom of the page.)

**B. HAZARDS IN DISASSEMBLY OF CHRONOGRAPH PIVOTED DETENT BRIDGE:**

When using a screwdriver to loosen the bridge from the detent, care should be taken to keep the bridge level, as any twisting may damage the pivot on the intermediary wheel or burr the bushings in the bridge or pivoted detent. The screwdriver should be carefully used to prevent marring of bridge or detent.

**C. ASSEMBLY PROCEDURE OF CHRONOGRAPH PIVOTED DETENT BRIDGE:**

Place the bridge on the pivoted detent with the steady pins over the proper holes in pivoted detent. Place the intermediary wheel so the pivot on this wheel will enter the bushing hole in the bridge. The bridge may be pressed to its proper place with back of tweezers, and chamfered flat head screw CS-1 replaced in the bridge.

**D. HAZARDS IN ASSEMBLY OF CHRONOGRAPH PIVOTED DETENT BRIDGE:**

Keep the bridge level when pressing down to its proper place, as any twisting may burr the bushing in the bridge or damage the pivot on the intermediary wheel. The bridge and detent, where these two parts come together, should be checked to see that there are no burrs that would prevent the bridge from setting properly on the chronograph pivoted detent.

**E. FUNCTION OF CHRONOGRAPH PIVOTED DETENT BRIDGE:**

The function of this bridge is to hold the intermediary wheel in position, so it can function properly.

**REFERENCE:** Chronograph pivoted detent is Assembly 45.

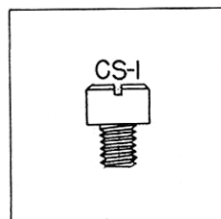

Chronograph  
Pivoted Detent  
Bridge  
Assembly 42



### OILING

The pivot in bushing in chronograph pivoted detent bridge should be oiled as you would properly oil a train pivot in a watch.

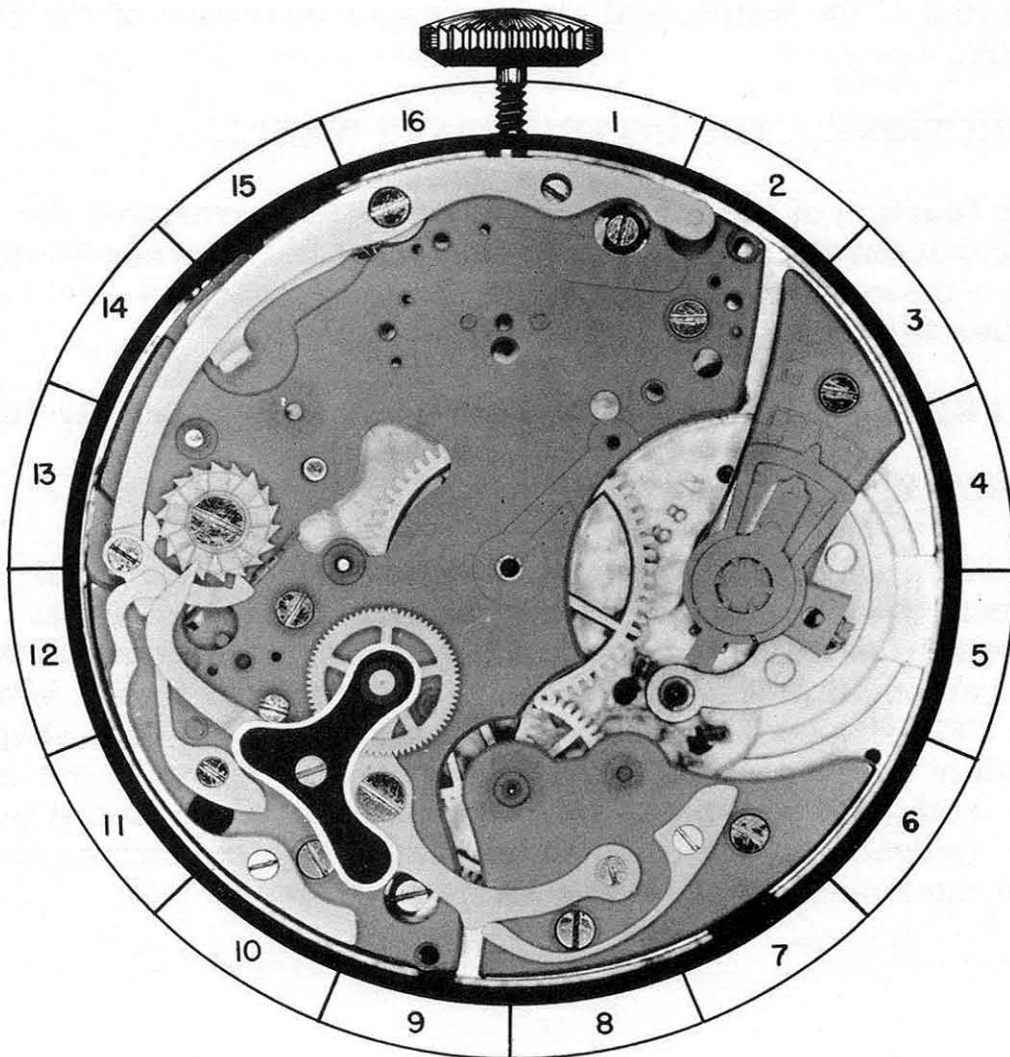

42-A

**A. DISASSEMBLY PROCEDURE OF INTERMEDIARY WHEEL:**

The intermediary wheel is simply lifted out of the bushing in the chronograph pivoted detent.

**B. ASSEMBLY PROCEDURE OF INTERMEDIARY WHEEL:**

When replacing the intermediary wheel, the long end "A" of the staff should be up. Place the bottom pivot of the staff in the hole in the bushing of the chronograph pivoted detent.

**C. HAZARDS IN ASSEMBLY OF INTERMEDIARY WHEEL:**

The pivot hole in bushing of the chronograph pivoted detent should be carefully examined for burrs before replacing intermediary wheel. Any imperfection here will affect the time-keeping of the watch, and hinder proper operation of the chronograph.

**D. FUNCTION OF THE INTERMEDIARY WHEEL:**

The function of the intermediary wheel is to transmit the power from the wheel over fourth wheel to the seconds wheel, when these wheels are engaged. The intermediary wheel continues to turn as long as the watch is running.

**REFERENCE:** Chronograph pivoted detent is Assembly 45.

**REMARKS:**

A careful and detailed examination should be made of all wheels before replacing in the chronograph. Each wheel should be examined for burred pivots, bent or burred teeth, dirt or small pieces of grit wedged between the teeth. When the VEE shaped teeth of one wheel mesh into the VEE shaped teeth of another wheel, there is very little clearance between the teeth, and because of this, the smallest piece of grit or dirt wedged into one of these teeth may stop the chronograph. The intermediary wheel has VEE shaped teeth.

Intermediary wheel  
Assembly 43.

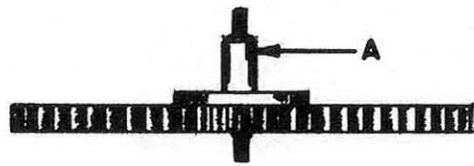

OILING

The bottom pivot of intermediary wheel should be oiled before replacing pivot in place in chronograph pivoted detent. The top pivot should be oiled, after bridge for this wheel is placed in watch.

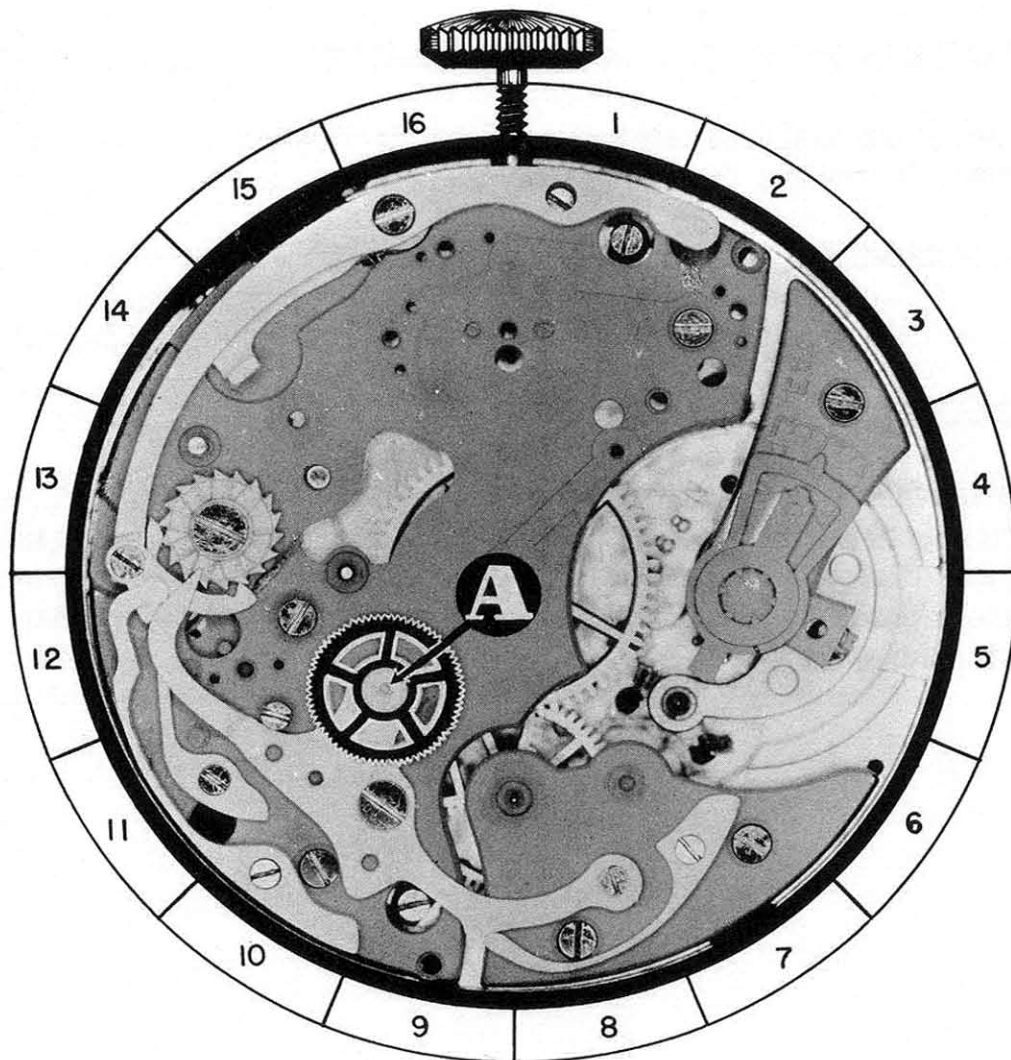

43-A



**A. DISASSEMBLY PROCEDURE OF CHRONOGRAPH PIVOTED DETENT SPRING:**

This spring is held in place by beveled countersink screw BS-8 and a steady pin. Remove the screw, and the steady pin will be free in the plate, and the detent spring may be lifted from the movement.

(The shape of screw for this part is shown at bottom of page.)

**B. ASSEMBLY PROCEDURE OF CHRONOGRAPH PIVOTED DETENT SPRING:**

Place the spring on the plate with the steady pin over the proper hole in the plate. Push the spring down flush on the plate, and replace beveled countersink screw BS-8.

**C. FUNCTION OF CHRONOGRAPH PIVOTED DETENT SPRING:**

This spring holds a tension on the chronograph pivoted detent, forcing it toward the center of the watch.

**REFERENCE:** Seconds wheel is Assembly 33.  
Intermediary wheel is Assembly 43.  
Chronograph pivoted detent is Assembly 45.

**REMARKS:**

The tension of the chronograph pivoted detent spring on the chronograph pivoted detent must be strong enough to engage the intermediary wheel with the seconds wheel. Any excess tension tends to make the chronograph mechanism harder to work manually.

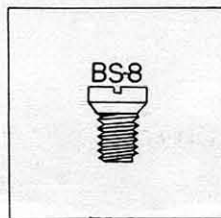

Chronograph Pivoted Detent  
Spring Assembly 44

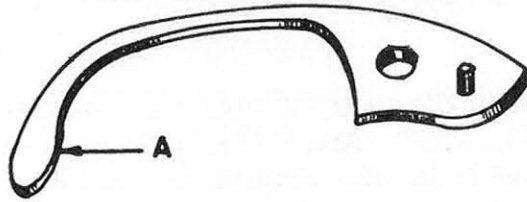

OILING

End "A" of the chronograph pivoted detent spring should be slightly moistened with oil at point of contact with the chronograph pivoted detent.

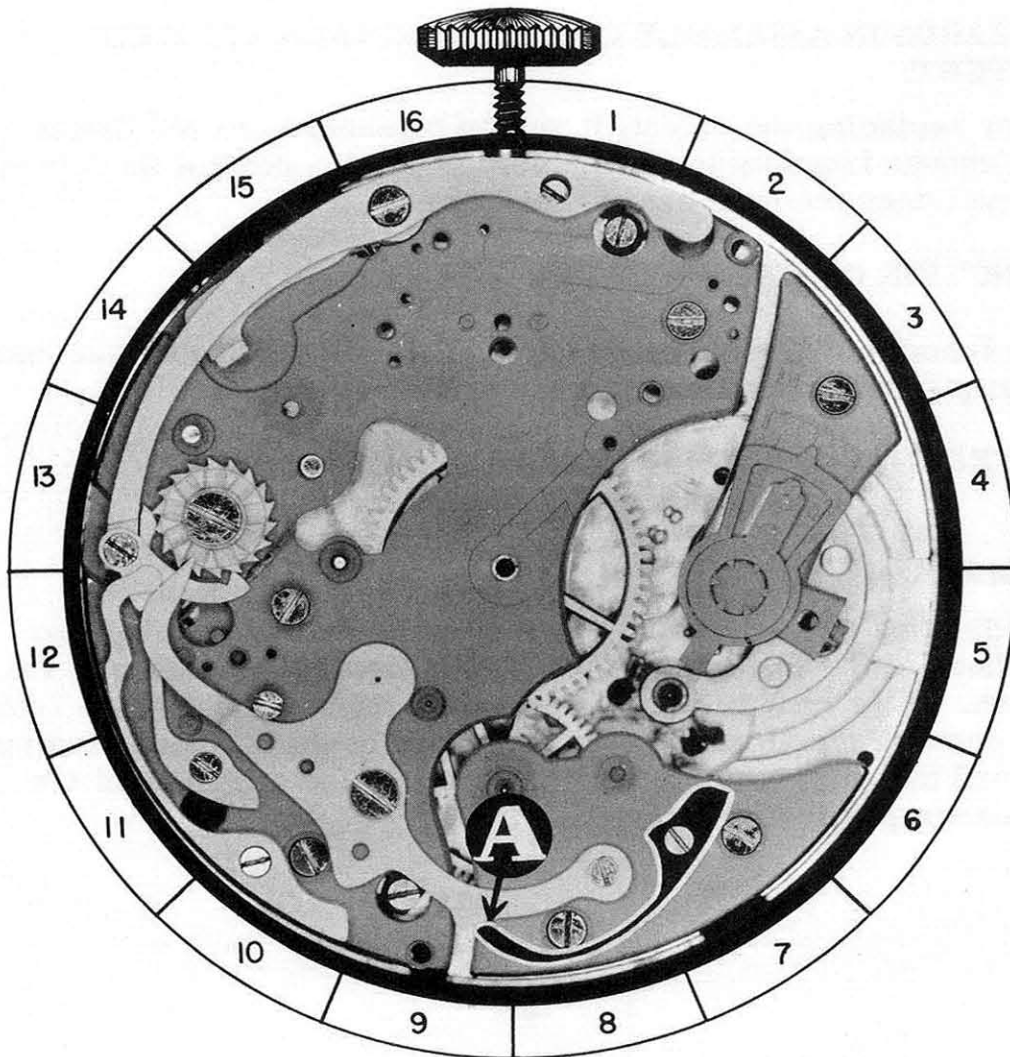

44-A

**A. DISASSEMBLY PROCEDURE OF CHRONOGRAPH PIVOTED DETENT:**

This detent is held in place by shouldered screw SS-20, and pivots on an eccentric stud. After this screw is removed, the detent may be lifted from the eccentric stud and free of plate.

(The shape of screw for this part is shown at bottom of page.)

**B. ASSEMBLY PROCEDURE OF CHRONOGRAPH PIVOTED DETENT:**

Place the detent in its proper position on the plate with the hole in end of detent over the eccentric stud, as the detent pivots on this stud. When the detent is in the proper position, replace shouldered screw SS-20. Check to see that the detent pivots freely under the head of shouldered screw SS-20, but does not have excessive freedom.

**C. HAZARDS IN ASSEMBLY OF CHRONOGRAPH PIVOTED DETENT:**

After replacing the detent, it should be checked to see that it has enough freedom to work freely under the head of the screw, and yet does not have excess freedom.

**D. FUNCTION OF CHRONOGRAPH PIVOTED DETENT:**

The function of the chronograph pivoted detent is to engage and disengage the intermediary wheel with the seconds wheel.

**REFERENCE:** Intermediary wheel is Assembly 43.  
Seconds wheel is Assembly 33.

**REMARKS:**

In adjusting eccentric stud ES-1, it must be kept in mind that the head of the stud must be eccentric toward the center of the watch. If the head of the stud has been turned 180 degrees from the correct adjustment, so that the head of the stud is eccentric toward the outside of the watch, it may cause a binding of the chronograph pivoted detent.

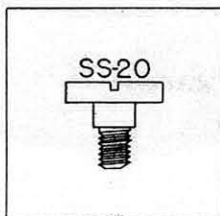

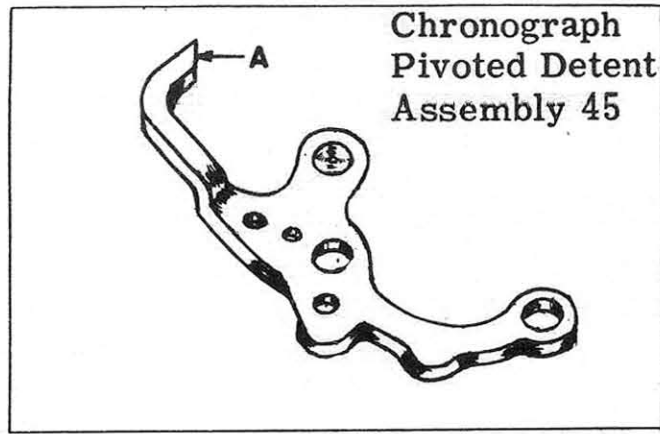

### OILING

The Eccentric Stud, that chronograph pivoted detent pivots on, should be slightly moistened with oil.

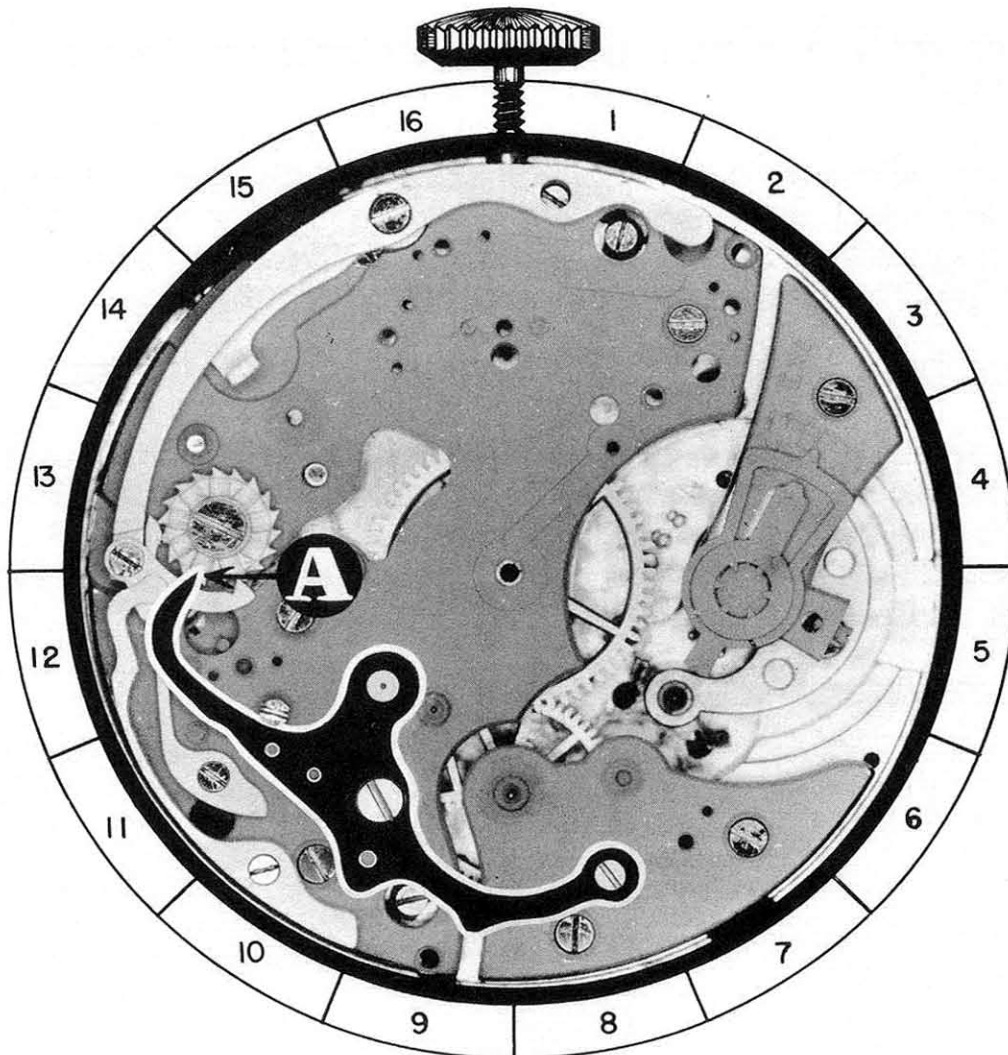

45-A

**A. DISASSEMBLY PROCEDURE OF ACTUATING DETENT LEVER SPRING:**

This spring is held in place by beveled countersink screw BS-9 and steady pins. After screw is removed, the spring may be loosened from the plate by sliding a fine screwdriver between the plate and the spring. After the steady pins are free in the plate, the spring may be lifted from the movement.

(The shape of screw for this part is shown at bottom of the page.)

**B. HAZARDS IN DISASSEMBLY OF ACTUATING DETENT LEVER SPRING:**

Hold finger over the spring when removing the screw, so the spring or screw does not shoot away.

**C. ASSEMBLY PROCEDURE OF ACTUATING DETENT LEVER SPRING:**

Place the spring on the plate with the steady pins over the proper holes in the plate. Shoulder "A" of the spring should rest against outside of the joint hook. When the spring is in this position, push down to proper place on the plate.

**D. FUNCTION OF ACTUATING DETENT LEVER SPRING:**

The function of this spring is to force the joint hook and the actuating detent lever back to the starting position each time the actuating detent lever has been pushed and released. Also, it holds the end "A" of the joint hook against the ratchet teeth on the castle wheel.

**REFERENCE:** Castle wheel is Assembly 51.  
Joint hook is Assembly 47.

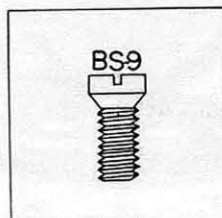

Actuating Detent Lever Spring  
Assembly 46

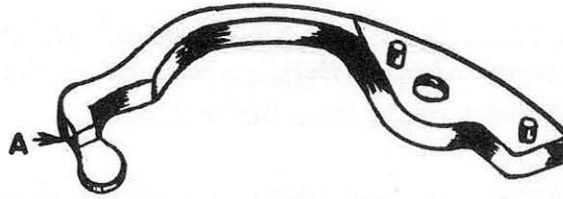

OILING

End "A" of actuating detent lever spring should be slightly moistened with oil at point of contact with joint hook.

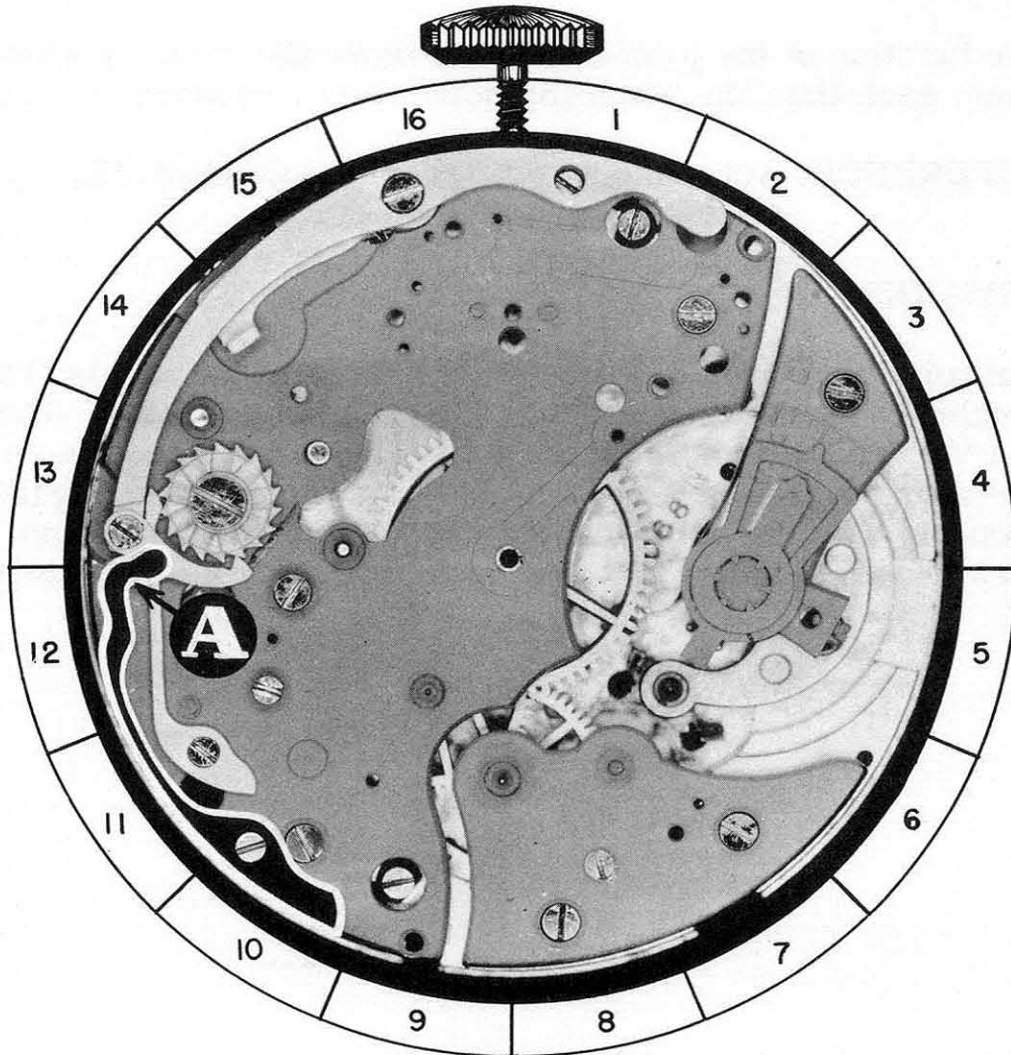

46-A

**A. DISASSEMBLY PROCEDURE OF JOINT HOOK:**

The joint hook is held in place by shouldered screw SS-21 and pivots on this screw. After this screw is removed, the joint hook may be removed from the actuating detent lever.

(The shape of screw for this part is shown at bottom of page.)

**B. ASSEMBLY PROCEDURE OF JOINT HOOK:**

The joint hook is placed in position on the end of the actuating detent lever. Replace the shouldered screw SS-21 to hold the joint hook to the actuating detent lever. The joint hook must turn freely under the head of this screw.

**C. FUNCTION OF THE JOINT HOOK:**

The function of the joint hook is to move the castle wheel one tooth, each time the actuating detent lever is moved manually.

**REFERENCE:** Actuating detent lever is Assembly 48.  
Castle wheel is Assembly 51.

**REMARKS:**

The joint hook should be carefully examined for any burrs or roughness that may cause it not to function properly. The end "A" of the joint hook should be highly polished, as any burrs or roughness may cause the joint hook not to engage properly with the ratchet teeth. When polishing this part, care should be taken that the shape of the hook is not changed.

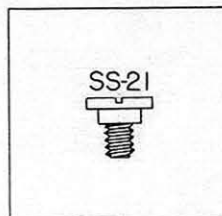

Joint Hook Assembly 47

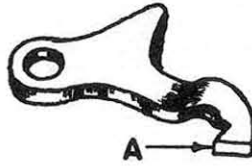

OILING

The shouldered screw, that joint hook pivots on, should be slightly moistened with oil.

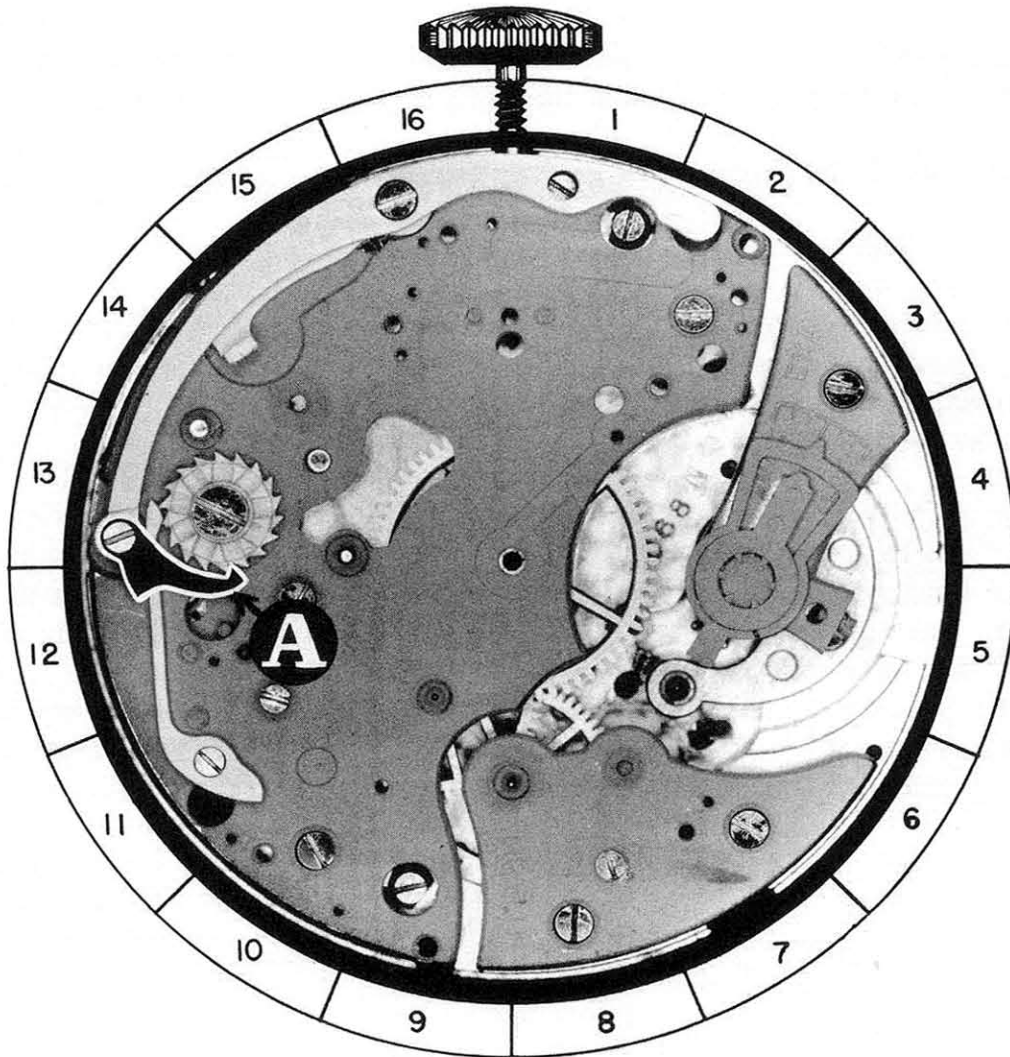

47-A



**A. DISASSEMBLY PROCEDURE OF ACTUATING DETENT LEVER:**

This lever is held in place by shouldered screw SS-22 and pivots on this screw. Remove the screw, and lift the lever from the plate.

(The shape of screw for this part is shown at the bottom of page.)

**B. ASSEMBLY PROCEDURE OF ACTUATING DETENT LEVER:**

The actuating detent lever is placed in its proper position on the plate, as shown in the photograph, and shouldered screw SS-22 replaced. The detent should pivot freely under the head of this screw.

**C. FUNCTION OF ACTUATING DETENT LEVER:**

The function of the actuating detent lever is to move the joint hook away from the center of the watch. This turns the castle wheel one tooth, each time the detent lever is pushed.

**REFERENCE:** Joint hook is Assembly 47.

**REMARKS:**

This chronograph is a semi-instantaneous type of chronograph. It is possible to note immediately if the chronograph is a semi-instantaneous type by observing the progress of the minute register hand.

The minute register hand on the semi-instantaneous type of chronograph will remain stationary until about the 58th second of registration. Between the 58th and 60th second of registration, the hand will move forward very slowly. At the 60th second of registration, the minute register hand will move forward very quickly to complete the registration of one minute on the dial. Of course, the minute register hand progresses in the same manner for each consecutive minute of registration.

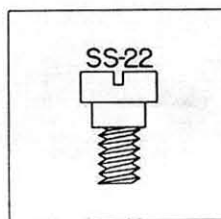

Actuating Detent Lever  
Assembly 48

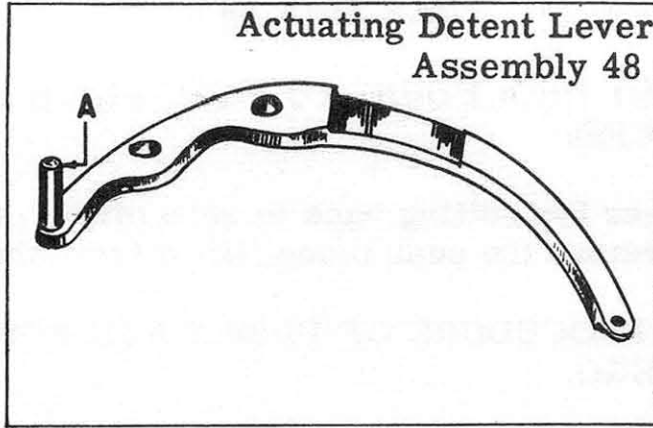

### OILING

The shouldered screw, that actuating detent lever pivots on, should be slightly moistened with oil.

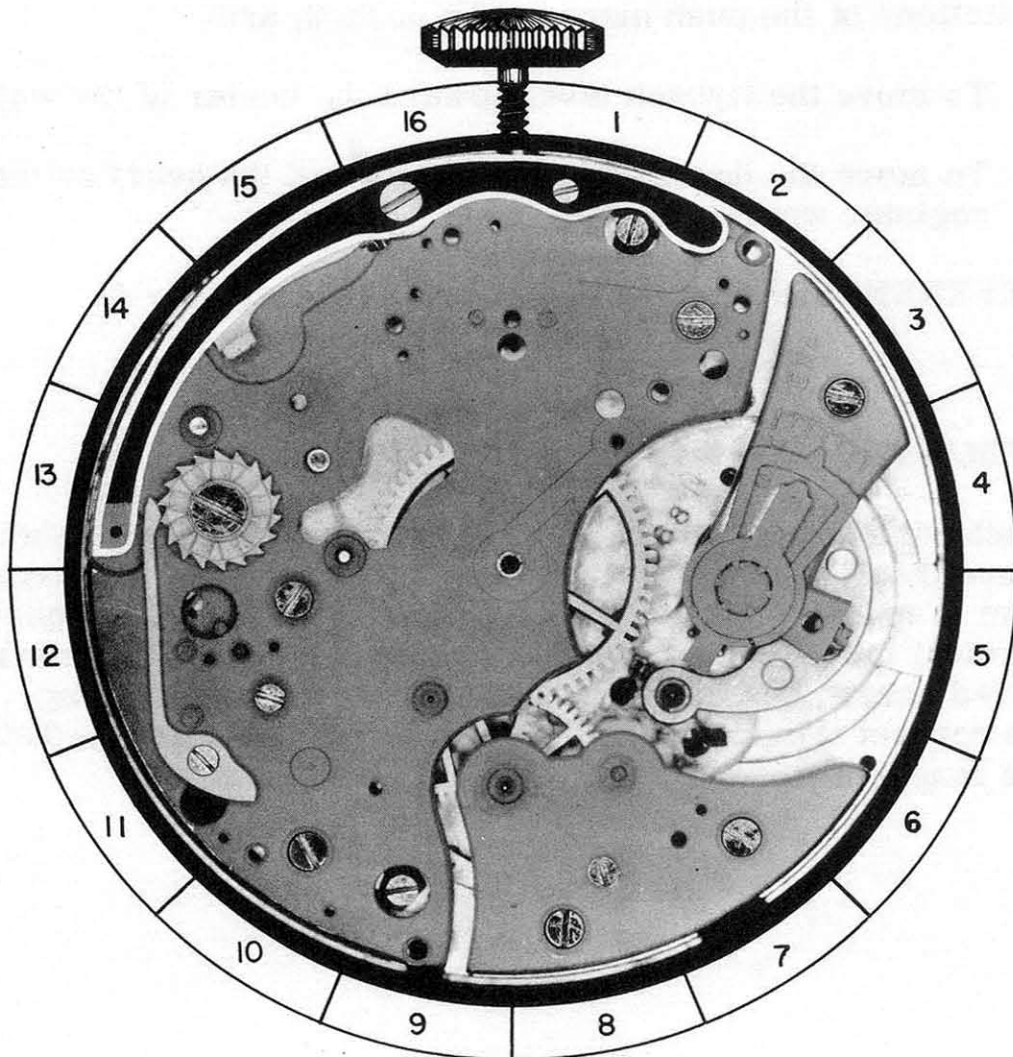

48-A

**A. DISASSEMBLY PROCEDURE OF PUSH PIECE FOR SETTING BACK TO ZERO:**

The push piece for setting back to zero pivots on a stud in the plate. To remove the push piece, lift it from the stud.

**B. ASSEMBLY PROCEDURE OF PUSH PIECE FOR SETTING BACK TO ZERO:**

Place the push piece in position in recess in plate with the hole in push piece over the hollow stud, as shown in the photograph. This part is held in place by the actuating detent lever which is the next part to be assembled.

**C. FUNCTION OF PUSH PIECE FOR SETTING BACK TO ZERO:**

Functions of the push piece, when pushed, are:

1. To move the flyback lever toward the center of the watch.
2. To move the hour flyback lever toward the heart on the hour register wheel.

**REFERENCE:** Actuating detent lever is Assembly 48.

Flyback lever is Assembly 31.

Hour flyback lever is Assembly 26.

**REMARKS:**

Each part that is held in place by a shouldered screw should move freely under the head of the screw. Any excess freedom is not desired. In the case where a part has too much vertical movement or endshake under the head of the shouldered screw, the shoulder on the screw may be too long. To correct this, cut back the shoulder on the screw, reducing the length of it.

**Push Piece for Setting Back  
To Zero**

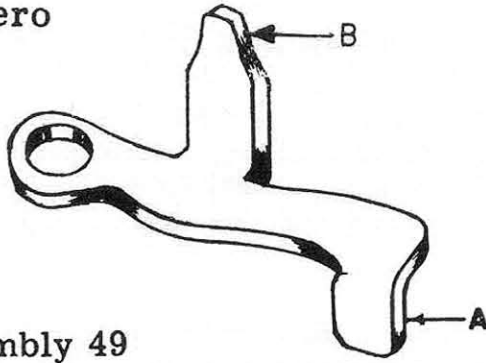

**OILING**

The stud, that push piece for setting back to zero pivots on, should be slightly moistened with oil.

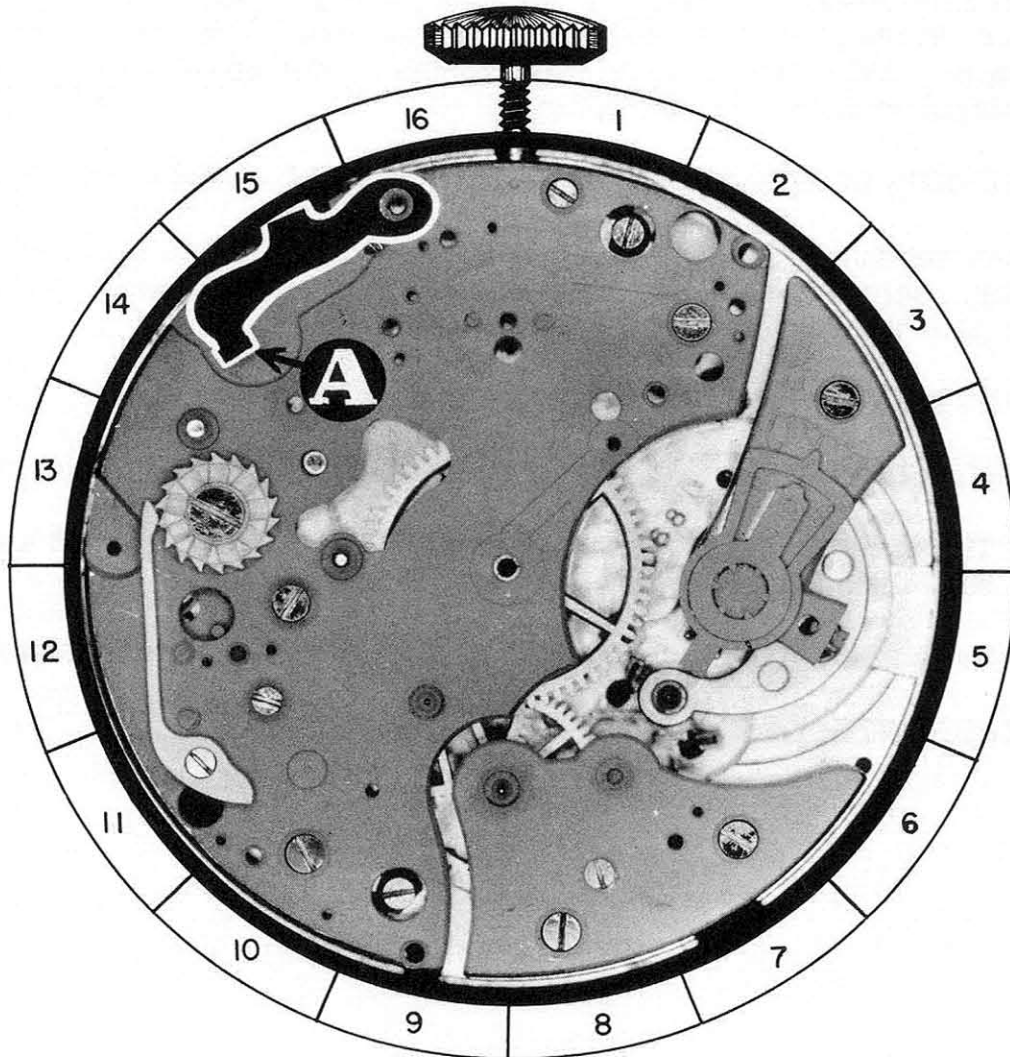

49-A

**A. DISASSEMBLY PROCEDURE OF CASTLE WHEEL PAWL:**

This pawl is held in place by beveled countersink screw BS-10 and steady pins. Remove this screw, and loosen the pawl from the plate by sliding a small, thin screwdriver between the plate and the pawl. After steady pins are free of the plate, the pawl may be lifted from the movement.

(The shape of screw for this part is shown at the bottom of page.)

**B. HAZARDS IN DISASSEMBLY OF CASTLE WHEEL PAWL:**

When removing the screw, hold finger over the pawl so there is no danger of the pawl or the screw shooting away.

**C. ASSEMBLY PROCEDURE OF CASTLE WHEEL PAWL:**

Place the pawl in position on the plate, using steady pins as a guide to set in the proper place. Then push the pawl down until it is flush with the plate. The beveled countersink screw BS-10 may now be replaced to hold the pawl in place.

**D. HAZARDS IN ASSEMBLY OF CASTLE WHEEL PAWL:**

When replacing the pawl, hold finger over the pawl so it cannot shoot away. Before replacing the screw, check to see that the end "A" of the pawl is engaged with the ratchet teeth.

**E. FUNCTION OF CASTLE WHEEL PAWL:**

The functions of the castle wheel pawl are as follows:

1. To correctly space the turning of the castle wheel, which assures the castle wheel will not set at an incorrect position.
2. To hold the castle wheel stationary until it is moved manually.

**REFERENCE:** Castle wheel is Assembly 51.

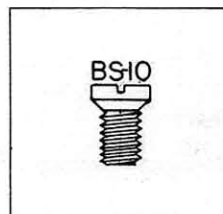

Castle Wheel Pawl  
Assembly 50

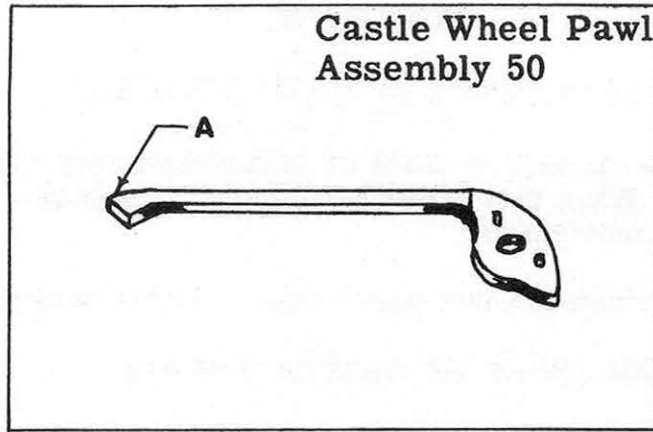

OILING

It is not necessary to oil the castle wheel pawl, as the ratchet teeth on the castle wheel are oiled.

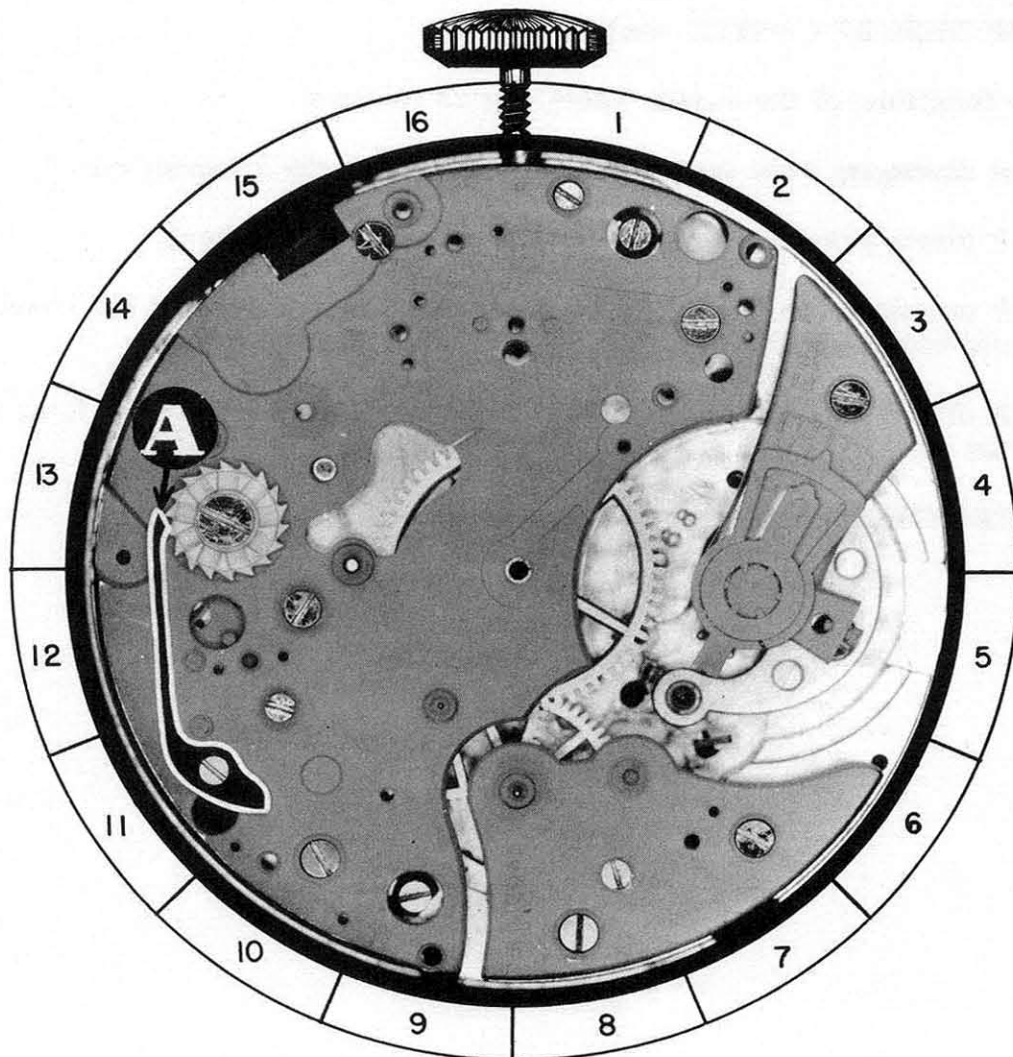

50-A

**A. DISASSEMBLY PROCEDURE OF CASTLE WHEEL:**

The castle wheel is held in place by shouldered screw SS-23 and pivots on this screw. When this screw is removed, the castle wheel may be lifted from the movement.

(The shape of screw for this part is shown at the bottom of the page.)

**B. ASSEMBLY PROCEDURE OF CASTLE WHEEL:**

Place the castle wheel in its proper position on the plate, and replace shouldered screw SS-23. The castle wheel should turn easily under the head of this screw, and yet not have excess freedom.

**C. HAZARDS IN ASSEMBLY OF CASTLE WHEEL:**

The plate and wheel should be examined for burrs that could prevent the wheel from turning freely.

**D. FUNCTION OF CASTLE WHEEL:**

The functions of the castle wheel are as follows:

1. It disengages the intermediary wheel from the seconds wheel.
2. It disengages the brake lever from the seconds wheel.
3. It prevents the flyback lever from being moved toward the center of the watch when the chronograph mechanism is engaged.
4. It disengages the intermediate hour wheel pinion from the hour register wheel.

**REFERENCE:** Intermediate hour wheel is Assembly 21 A.  
Hour register wheel is Assembly 18.  
Intermediary wheel is Assembly 43.  
Brake lever is Assembly 37.  
Flyback lever is Assembly 31.

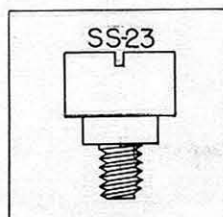

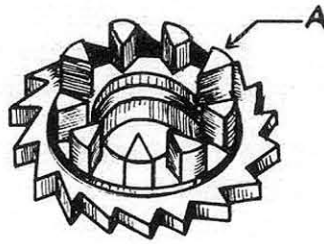

Castle Wheel Assembly 51

OILING

THESE PARTS OF CASTLE WHEEL SHOULD BE SLIGHTLY MOISTENED WITH OIL

1. The shouldered screw that castle wheel pivots on.
2. The columns on castle wheel "A" at the points they contact the parts of this mechanism.
3. The ratchet teeth on castle wheel at point of contact with the joint hook.

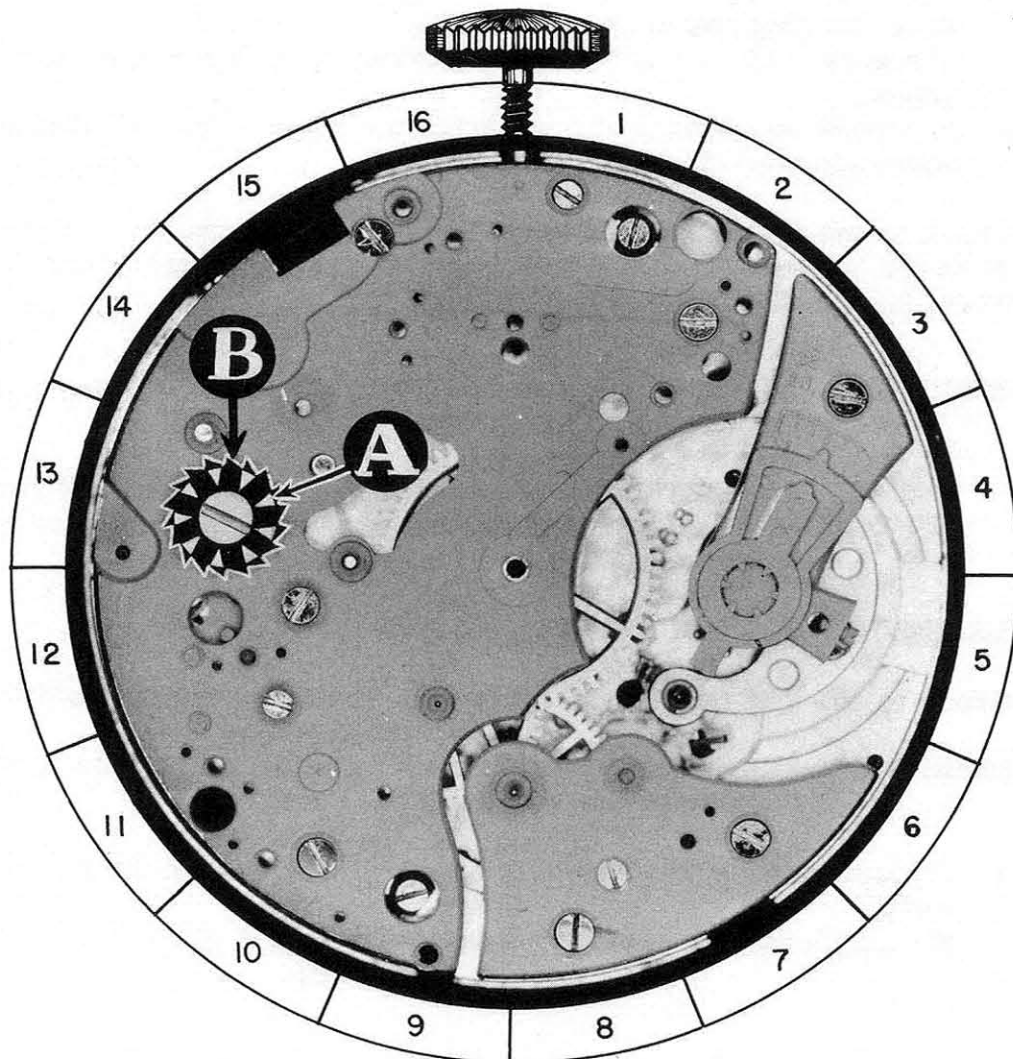

51A



## FUNCTIONAL RESULTS

After completely assembling the chronograph with the exception of the bezel and the back of the case, place the chronograph in front of you, pendant up, with the back of the chronograph facing you.

### 1. PUSH THE BUTTON AT LEFT OF PENDANT, HOLD IN THIS POSITION, AND CHECK THE FOLLOWING:

(Make sure that castle wheel is in the proper position so button can be pushed.)

- A. Check to see that the seconds wheel, minute register wheel, and hour register wheel return the hands connected to these wheels to a zero position.

**CORRECTION:** The following errors could prevent these hands from returning to a zero position:

- a. Loose hands or hands not being set correctly.
  - b. The minute register wheel, hour register wheel, or the seconds wheel binding and not turning freely.
  - c. The ends "A" or "B" of flyback lever not being of the correct length.
  - d. Improper adjustment of eccentric stud ES-5. (See adjustment of eccentric studs in front of the book.)
- B. Check to see that the end of the minute register pawl lies directly centered between two teeth on the minute register wheel, when this wheel is at a zero position.

**CORRECTION:** The pawl being bent will cause it not to set correctly on the minute register wheel.

Failure to have this pawl properly adjusted will result in the minute register wheel moving after the flyback lever has moved away from the heart.

### 2. RELEASE THE BUTTON AND CHECK THE FOLLOWING:

- A. Check to see that the flyback lever returns to its original position.

**CORRECTION:** The following errors could prevent the flyback lever from returning to its original position:

- a. Flyback lever spring not holding enough tension on the flyback lever.
- b. Flyback lever not turning freely on the post in plate.

(Continued on next page)

FUNCTIONAL RESULTS  
(Continued)

3. PUSH THE BUTTON AT RIGHT OF PENDANT, RELEASE IT, AND CHECK THE FOLLOWING:

A. Check the depthing of teeth on the intermediary wheel with teeth on the seconds wheel.

**CORRECTION:** The following errors could prevent the correct depthing of these teeth:

- a. Chronograph pivoted detent spring not holding enough tension on the chronograph pivoted detent.
- b. Chronograph pivoted detent not turning freely.
- c. Improper adjustment of eccentric stud ES-2. (See adjustment of eccentric studs in front of the book.)

B. Check depthing of seconds wheel dart tooth with intermittent wheel teeth.

**CORRECTION:** The following errors could prevent proper depthing of dart tooth with intermittent wheel teeth:

- a. Intermittent lever not turning freely on post in plate.
- b. Improper adjustment of eccentric stud ES-3. (See adjustment of eccentric studs in front of the book.)

**REMARKS:** If the depthing of the intermittent wheel teeth with the seconds wheel dart tooth is deep, the minute register wheel may move two teeth, each time the seconds wheel makes one revolution.

If the depthing is shallow, it may result in the minute register wheel not moving a tooth, and thus, not registering the minutes on the dial.

C. Check to see that the seconds hand moves forward in a steady manner, with no irregular jumping or jerking.

**CORRECTION:** This irregular movement of the seconds hand is usually caused by the seconds wheel tension spring not holding enough tension on the seconds wheel.

4. PUSH THE BUTTON AT RIGHT OF PENDANT A SECOND TIME, RELEASE IT, AND CHECK THE FOLLOWING:

A. Check to see that the brake lever is in contact with the seconds wheel.

**CORRECTION:** The following errors could prevent the brake lever from contacting the seconds wheel:

(Continued on next page)

**FUNCTIONAL RESULTS**  
(Continued)

- a. Brake lever not turning freely under the head of the screw.
- b. Brake lever spring not holding enough tension on the brake lever.

**TURN CHRONOGRAPH OVER, DIAL SIDE FACING YOU, PENDANT UP.**

**5. PUSH THE BUTTON ON THE LEFT AT THE BOTTOM OF THE CHRONOGRAPH.**

- A. Check to see that the month is advanced on the dial, each time this button is pushed.

**CORRECTION:** The following errors could prevent the month from changing on the dial:

- a. The month wheel setting detent binding.
- b. The star wheel of months binding.

**6. PUSH THE BUTTON ON THE RIGHT AT THE BOTTOM OF THE CHRONOGRAPH.**

- A. Check to see that the date hand advances one space on the dial, each time this button is pushed.

**CORRECTION:** The following errors could prevent the date hand from advancing one space, each time the button is pushed:

- a. The date wheel setting detent binding.
- b. The date wheel binding.

**7. PULL PENDANT OUT TO SETTING POSITION AND TURN PENDANT CLOCKWISE UNTIL DAY AND DATE CHANGE.**

- A. Check to see that the day and date change at approximately the same time.

**CORRECTION:** The following error could prevent the day and date from changing at the same time:

- a. Improper setting of intermediate date wheel in conjunction with pin on intermediate day wheel.

- B. Check to see that the day and date change as close as possible to twelve o'clock, but not before twelve o'clock.

**CORRECTION:** The following error could prevent the day and date changing as close as possible to twelve o'clock:

- a. The hour and minute hands not being replaced at 12 on dial at the instant the day and date change on the dial.

(Continued on next page)

## FUNCTIONAL RESULTS

(Continued)

### 8. REPLACE BEZEL AND BACK OF CASE, AND PUSH THE BUTTON TO SET CHRONOGRAPH MECHANISM IN OPERATION.

- A. Check to see, after a period of time, that the hour register hand is properly registering the hour on the dial.

**CORRECTION:** The following errors could prevent hour register hand from properly registering the hours:

- a. Intermediate hour yoke not moving freely.
- b. Intermediate hour yoke spring not holding a strong enough tension on intermediate hour yoke.
- c. Improper adjustment of eccentric stud ES-4. (See adjustment of eccentric studs in front of the book.)

### 9. PUSH THE BUTTON TO RETURN THE HANDS TO A ZERO POSITION, RELEASE IT, AND CHECK THE FOLLOWING:

- A. Check, for a period of at least one half hour, to see that the hour register hand remains at a zero position.

**CORRECTION:** The following errors could prevent the hour register hand from remaining at a zero position:

- a. Intermediate yoke binding and not working freely.
- b. The long pin on intermediate hour yoke being bent and not disengaging the hour register wheel from the intermediate hour wheel pinion.

## DAY OF THE WEEK TRACK

- A. The day of the week track indicates the day of the week. This track should move forward one space every 24 hours and registers the passing days of the week automatically.

## DATE TRACK

- B. The purpose of the date track is to indicate the date. This is done by the date hand registering the date on this track. The date hand is mechanically controlled by the calendar mechanism and moves forward one space every 24 hours. This changes the date on the dial. The date hand must be corrected manually at the end of each month for those months having less than 31 days.

## SECOND HAND

- C. The second hand indicates the passing of seconds and should move one space each second. One complete revolution of hand denotes passage of one minute. This hand is independent of chronograph mechanism and continues to register the seconds as long as watch is running.

## MONTH TRACK

- D. The purpose of the month track is to indicate the month of the year. This track is manually controlled and must be corrected at the end of each month.

## SPLIT SECOND SCALE

- E. This scale is divided into 300 divisions each indicating  $1/5$  of a second. Every fifth division is marked with extra long lines denoting one second. The main purpose of this scale is to measure a fraction of a second accurately.

## MINUTE REGISTER

- F. The minute register hand indicates the passing of minutes. This hand should move forward one space each minute as long as the chronograph mechanism is in operation. One complete revolution of minute register hand indicates passage of 30 minutes. Two revolutions, one hour.

## HOUR REGISTER

- G. This hand registers the passing of hours. Each division on scale denotes  $1/2$  hour. Each number on scale denotes the hour. One complete revolution of hour register hand indicates 12 hours has elapsed. This hand will register the hours as long as the chronograph mechanism is in operation.

## THE CHRONOGRAPH DIAL

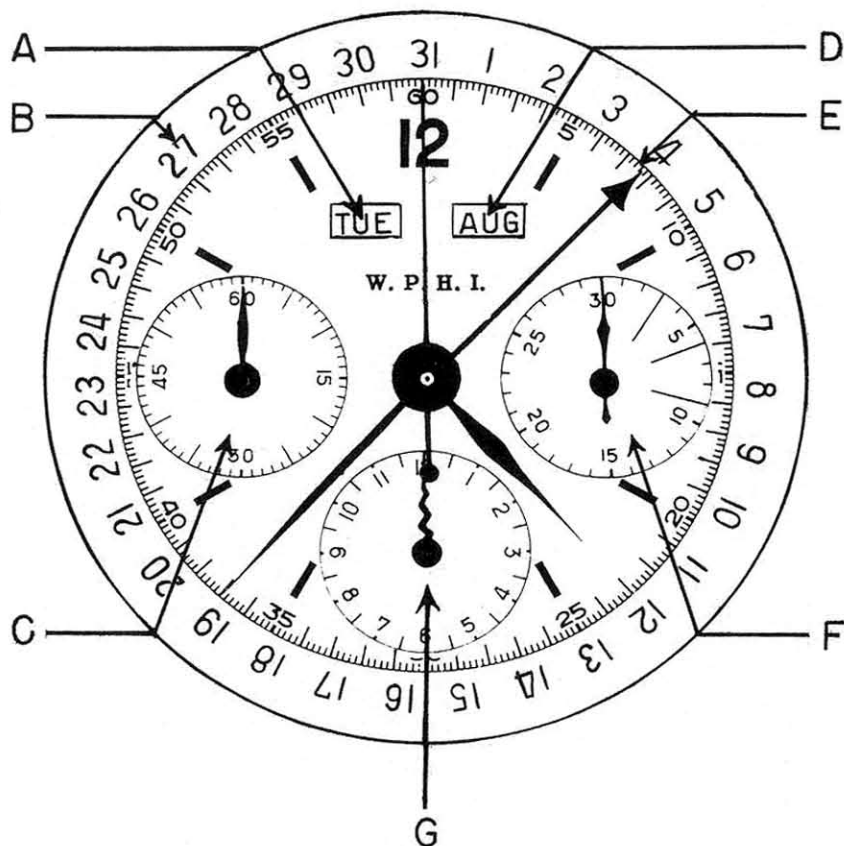

### SETTING THE HANDS CORRECTLY

After the chronograph is completely assembled and in working condition, place the chronograph in its case. Now replace the hands as follows:

1. Replace the date hand with hand pointing to 31 on the date scale "B".
2. Replace the hour hand and minute hand using the same procedure that is followed in replacing these hands on a calendar watch.

(The replacing of the hour hand and minute hand on a calendar watch is explained in Volume 16 and Volume 6.)

After the hour hand and minute hand are replaced, replace the second hand using the same procedure that is followed in replacing a second hand on a regular watch.

Now push the button and bring the flyback lever in toward the center of the watch and hold it in this position.

3. Replace the sweep seconds hand with hand pointing to 60 on split second scale "E".
4. Replace the minute register hand with hand pointing to 30 on the minute register scale "F".
5. Replace the hour register hand with hand pointing to 12 on the hour register scale "G".

Now release the chronograph button, permitting the flyback lever to return to its original position.