

# Calibre 71

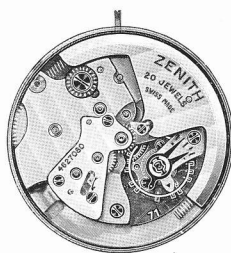

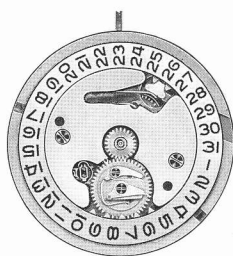

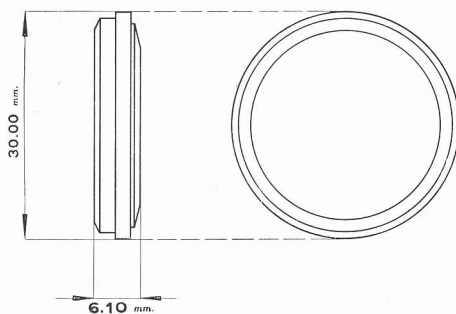





13<sup>mm</sup> Ancre — 21,600 alternances











































71









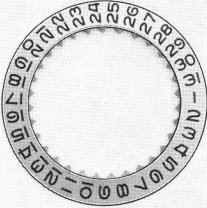

- 71 Automatique avec seconde au centre directe
- Quantième à saut semi-instantané
- Pare-chocs
- Réglage plat

	■	149	Support-logement de vis de fixation
		163/1	Tube de centre empierré <i>Indiquer hauteur de chaussée</i>
	■	180	Barillet avec arbre
	■	180/1	Barillet complet (avec ressort)
	■	195	Arbre de barillet
	■	200/1	Grande moyenne avec chaussée (placée hors du centre)
	■	210	Roue moyenne
		227	Roue de seconde au centre <i>Indiquer hauteur de chaussée</i>
	■	240	Chaussée lanternée
		243	Chaussée non lanternée <i>Indiquer hauteur</i>
	■	260	Roue de minuterie
	■	301	Raquette pour spiral plat

	■	401	Tige de remontoir
	■	407	Pignon coulant
	■	410	Pignon de remontoir
	■	416	Rochet dessous
	■	417	Rochet intermédiaire
	■	418/1	Chapeau de roue de couronne
	■	418/2	Chapeau de rochet intermédiaire
	■	420	Roue de couronne
	■	422	Bague de roue de couronne
	■	422/1	Bague de rochet intermédiaire
	■	435	Bascule
	■	440	Ressort de bascule
	■	443	Tirette
	■	445	Ressort de tirette
	■	450	Renvoi
	■	469	Plaque de maintien de la roue des heures
	■	476	Ressort de roue de minuterie
	■	477	Ressort d'emboîtement
	■	502	Axe de tirette
	■	516	Roue de couronne intermédiaire à breguet
	■	517	Axe de roue de couronne intermédiaire à breguet
	■	518	Ressort de roue de couronne intermédiaire à breguet

	■ 705	Roue d'ancre pivotée
	■ 710	Ancre montée
	■ 719	Balancier sans axe
	■ 720	Balancier pivoté avec plateau
	■ 721	Balancier avec spiral plat
	■ 724	Axe de balancier «Incabloc»
	■ 730	Plateau
	■ 734/1	Spiral plat réglé, piton triangulaire
	■ 770	Ressort de barillet
	■ 775	Ressort de freinage (bride glissante)
	■ 1143	Masse oscillante
	■ 1427	Cliquet d'impulsion
	■ 1428	Cliquet d'arrêt
	■ 1448	Ressort du cliquet d'arrêt
	■ 1449	Ressort du cliquet d'impulsion
	■ 1472	Ressort amortisseur
	■ 1478	Roue de masse oscillante (25 dents)
	■ 1481	Mobile de réduction (34 dents)
	■ 1482	Mobile entraîneur de rochet
	■ 1496	Axe de masse oscillante (chassé)

	2535	Plaque de maintien de l'indicateur de quantième
	2556	Roue entraîneuse de l'indicateur de quantième
	2557/1	Indicateur de quantième décalqué
	2558	Roue des heures double denture
	2575	Ressort du sautoir de quantième
	2576	Sautoir de quantième
	2632	Bascule de déclenchement de l'indicateur de quantième
	2634	Cliquet de recul de l'indicateur de quantième

■ ●	601	Pierre de grande moyenne dessus
■	605	Pierre de roue moyenne dessus
■	606	Pierre de roue moyenne dessous
■	612	Pierre de roue de seconde au centre dessus
■	615	Pierre de roue d'ancre dessus et dessous
■ ●	620	Pierre d'ancre dessus et dessous
■	646	Palette d'entrée
■	647	Palette de sortie
■	648	Cheville de plateau
■	714	Tige d'ancre
■	1624	Pierre du mobile entraîneur de rochet dessus
■	1641	Pierre de masse oscillante dessus et dessous
■	1643	Pierre du mobile de réduction dessus

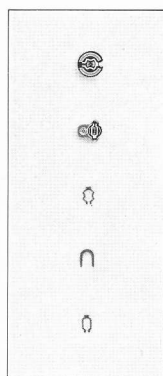

■ ●	324	«Incabloc» dessus
■ ●	326	«Incabloc» dessous
■ ●	3241	Ressort dessus
■ ●	3244	Verrou
■ ●	3261	Ressort dessous
■ ●	3242	Pierre de contre-pivot dessus
■ ●	3243	Chaton dessus et dessous
■ ●	3252	Pierre de contre-pivot dessous
■ ●	3255	Vis de fixation «Incabloc» dessous

■ V. tableau de concordance  
 ● V. tableau de concordance

■ ● 5101	Vis de fixation
■ ● 5105	Vis de pont de barillet et coq
■ ● 5125	Vis de pont d'ancre
■ 5126	Vis de barette de roue de centre
■ 5149	Vis de support-logement de vis de fixation
■ ● 5163/1	Vis de tube de centre
■ 5417	Vis de rochet intermédiaire
■ 5418/1	Vis de chapeau de roue de couronne
■ 5445	Vis de ressort de tirette
■ 5469	Vis de plaque de maintien de la roue des heures
■ 5477	Vis de ressort d'emboitage
■ 5518	Vis de ressort de roue de couronne intermédiaire à breguet
■ 5738/1	Vis de piton
■ 5750	Vis de cadran
■ 51142	Vis de pont supérieur du dispositif automatique
■ 51427	Vis de cliquet d'impulsion
■ 51448	Vis de ressort du cliquet d'arrêt
■ 51449	Vis de ressort du cliquet d'impulsion
52535	Vis de plaque de maintien de l'indicateur de quantième
52632	Vis de bascule de déclenchement de l'indicateur de quantième
52634	Vis de cliquet de recul de l'indicateur de quantième

■ V. tableau de concordance

● V. tableau de concordance